

Fifth Edition

An Introduction to

Object-Oriented Programming

*with Java*TM

C. Thomas Wu

An Introduction to Object-Oriented Programming with **Java**TM

Fifth Edition

C. Thomas Wu

Naval Postgraduate School



Higher Education

Boston Burr Ridge, IL Dubuque, IA New York San Francisco St. Louis
Bangkok Bogotá Caracas Kuala Lumpur Lisbon London Madrid Mexico City
Milan Montreal New Delhi Santiago Seoul Singapore Sydney Taipei Toronto



Higher Education

AN INTRODUCTION TO OBJECT-ORIENTED PROGRAMMING WITH JAVA™, FIFTH EDITION

Published by McGraw-Hill, a business unit of The McGraw-Hill Companies, Inc., 1221 Avenue of the Americas, New York, NY 10020. Copyright © 2010 by The McGraw-Hill Companies, Inc. All rights reserved. Previous editions © 2006, 2004, and 2001. No part of this publication may be reproduced or distributed in any form or by any means, or stored in a database or retrieval system, without the prior written consent of The McGraw-Hill Companies, Inc., including, but not limited to, in any network or other electronic storage or transmission, or broadcast for distance learning.

Some ancillaries, including electronic and print components, may not be available to customers outside the United States.

This book is printed on acid-free paper.

1 2 3 4 5 6 7 8 9 0 DOC/DOC 0 9

ISBN 978-0-07-352330-9

MHID 0-07-352330-5

Global Publisher: *Raghothaman Srinivasan*
Director of Development: *Kristine Tibbetts*
Developmental Editor: *Lorraine K. Buczek*
Senior Marketing Manager: *Curt Reynolds*
Senior Project Manager: *Jane Mohr*
Lead Production Supervisor: *Sandy Ludovissy*
Lead Media Project Manager: *Stacy A. Patch*
Associate Design Coordinator: *Brenda A. Rolwes*
Cover Designer: *Studio Montage, St. Louis, Missouri*
(USE) Cover Image: © *Getty Images*
Compositor: *Macmillan Publishing Solutions*
Typeface: *10.5/12 Times Roman*
Printer: *R. R. Donnelley Crawfordsville, IN*

All credits appearing on page or at the end of the book are considered to be an extension of the copyright page.

Library of Congress Cataloging-in-Publication Data

Wu, C. Thomas.

An introduction to object-oriented programming with Java / C. Thomas Wu (Otani).—5th ed.

p. cm.

Includes index.

ISBN 978-0-07-352330-9— ISBN 0-07-352330-5 (hard copy : alk. paper) 1. Object-oriented programming (Computer science) 2. Java (Computer program language) I. Title.

QA76.64.W78 2010

005.1'17—dc22

2008053612

www.mhhe.com

To my family

Contents

Preface	xi
0 Introduction to Computers and Programming Languages	1
0.1 A History of Computers	2
0.2 Computer Architecture	4
0.3 Programming Languages	11
0.4 Java	12
1 Introduction to Object-Oriented Programming and Software Development	15
1.1 Classes and Objects	16
1.2 Messages and Methods	18
1.3 Class and Instance Data Values	20
1.4 Inheritance	23
1.5 Software Engineering and Software Life Cycle	24
2 Getting Started with Java	29
2.1 The First Java Program	30
2.2 Program Components	39
2.3 Edit-Compile-Run Cycle	49
2.4 Sample Java Standard Classes	52
2.5 Sample Development	69

3	Numerical Data	85
3.1	Variables	86
3.2	Arithmetic Expressions	94
3.3	Constants	99
3.4	Displaying Numerical Values	101
3.5	Getting Numerical Input	107
3.6	The Math Class	113
3.7	Random Number Generation	117
3.8	The GregorianCalendar Class	120
3.9	Sample Development	125
3.10	Numerical Representation (<i>Optional</i>)	136
4	Defining Your Own Classes—Part 1	151
4.1	First Example: Defining and Using a Class	152
4.2	Second Example: Defining and Using Multiple Classes	162
4.3	Matching Arguments and Parameters	166
4.4	Passing Objects to a Method	168
4.5	Constructors	173
4.6	Information Hiding and Visibility Modifiers	180
4.7	Class Constants	183
4.8	Local Variables	191
4.9	Calling Methods of the Same Class	193
4.10	Changing Any Class to a Main Class	197
4.11	Sample Development	198
5	Selection Statements	221
5.1	The if Statement	222
5.2	Nested if Statements	233
5.3	Boolean Expressions and Variables	239
5.4	Comparing Objects	247
5.5	The switch Statement	252
5.6	Drawing Graphics	256
5.7	Enumerated Constants	266
5.8	Sample Development	272

6	Repetition Statements	303
6.1	The while Statement	304
6.2	Pitfalls in Writing Repetition Statements	313
6.3	The do-while Statement	319
6.4	Loop-and-a-Half Repetition Control	323
6.5	The for Statement	327
6.6	Nested for Statements	332
6.7	Formatting Output	334
6.8	Loan Tables	339
6.9	Estimating the Execution Time	342
6.10	Recursive Methods (<i>Optional</i>)	346
6.11	Sample Development	351
7	Defining Your Own Classes—Part 2	373
7.1	Returning an Object from a Method	374
7.2	The Reserved Word this	378
7.3	Overloaded Methods and Constructors	386
7.4	Class Variables and Methods	391
7.5	Call-by-Value Parameter Passing	395
7.6	Organizing Classes into a Package	402
7.7	Using Javadoc Comments for Class Documentation	403
7.8	The Complete Fraction Class	408
7.9	Sample Development	418
8	Exceptions and Assertions	445
8.1	Catching Exceptions	446
8.2	Throwing Exceptions and Multiple catch Blocks	453
8.3	Propagating Exceptions	458
8.4	Types of Exceptions	466
8.5	Programmer-Defined Exceptions	469
8.6	Assertions	471
8.7	Sample Development	477

9	Characters and Strings	495
9.1	Characters	496
9.2	Strings	499
9.3	Pattern Matching and Regular Expression	510
9.4	The Pattern and Matcher Classes	517
9.5	Comparing Strings	521
9.6	StringBuffer and StringBuilder	523
9.7	String Processing and Bioinformatics	529
9.8	Sample Development	533
10	Arrays and Collections	555
10.1	Array Basics	556
10.2	Arrays of Objects	567
10.3	The For-Each Loop	577
10.4	Passing Arrays to Methods	582
10.5	Two-Dimensional Arrays	589
10.6	Lists and Maps	596
10.7	Sample Development	609
11	Sorting and Searching	633
11.1	Searching	634
11.2	Sorting	638
11.3	Heapsort	646
11.4	Sample Development	659
12	File Input and Output	685
12.1	File and JFileChooser Objects	686
12.2	Low-Level File I/O	695
12.3	High-Level File I/O	700

12.4	Object I/O	709
12.5	Sample Development	716

13 Inheritance and Polymorphism 733

13.1	A Simple Example	734
13.2	Defining Classes with Inheritance	737
13.3	Using Classes Effectively with Polymorphism	741
13.4	Inheritance and Member Accessibility	744
13.5	Inheritance and Constructors	749
13.6	Abstract Superclasses and Abstract Methods	753
13.7	Inheritance versus Interface	758
13.8	Sample Development	759

14 GUI and Event-Driven Programming 787

14.1	Simple GUI I/O with JOptionPane	790
14.2	Customizing Frame Windows	793
14.3	GUI Programming Basics	799
14.4	Text-Related GUI Components	808
14.5	Layout Managers	820
14.6	Effective Use of Nested Panels	830
14.7	Other GUI Components	839
14.8	Menus	857
14.9	Handling Mouse Events	861

15 Recursive Algorithms 881

15.1	Basic Elements of Recursion	882
15.2	Directory Listing	883
15.3	Anagram	885
15.4	Towers of Hanoi	888
15.5	Quicksort	890
15.6	When Not to Use Recursion	895

Appendix A	How to Run Java Programs	903
Appendix B	Sample Programs	911
Appendix C	Standard Classes and Interfaces	933
Appendix D	UML Diagrams	955
Index		963

Preface

This book is an introduction to object-oriented programming using the Java programming language. We use the object-first approach where objects are used from the first sample program. Object-oriented thinking is emphasized and promoted from the beginning. Students learn how to use objects first and then learn how to define their own objects.

Key Changes in the 5th Edition

The key differences between this edition and the fourth edition are as follows:

- 1. More Discussion on Java 5.0 Features and Java 6.0 Compatibility.** Many of the new Java 5.0 features are explained and used in the sample programs. They include the enumerator type, the for-each loop construct, auto boxing and unboxing, and the generics.
- 2. Exclusive Use of Console Input and Output.** All the GUI related topics, including the `JOptionPane` class, are moved to Chapter 14. Sample programs before Chapter 14 use the standard console input (`Scanner`) and output (`System.out`). Those who want to use `JOptionPane` for simple input and output can do so easily by covering Section 14.1 before Chapter 3.
- 3. More Examples from Natural Sciences.** In several key chapters, we illustrate concepts using examples from biology and chemistry. For example, in Chapter 4, we use the elements in the periodic table to illustrate the concept of programmer-defined classes. In Chapter 9, we demonstrate how the string processing techniques are applied to implement DNA sequencing and other common DNA operations.
- 4. Level-by-level Organization for Programming Exercises.** Programming exercises at the end of chapters are organized into three levels of difficulties. The one-star level exercises require the basic understanding of the materials covered in the chapter. The two-star level exercises require some additional thinking beyond the basic understanding. The three-star level exercises are

most difficult and require significant effort. For some of the three-star exercises, students must find or study additional information beyond those presented in the book. Please keep in mind that the level of difficulties is only a general guideline. One student may find some level-three exercises much easier than level-two exercises, for example.

Book Organization

There are 16 chapters in this book, numbered from 0 to 15. The first 11 chapters cover the core topics that provide the fundamentals of programming. Chapters 11 to 15 cover intermediate-level topics such as sorting, searching, recursion, inheritance, polymorphism, and file I/O. There are more than enough topics for one semester. After the first 11 chapters (Ch 0 to Ch 10), instructors can mix and match materials from Chapters 11 to 15 to suit their needs. We first show the dependency relationships among the chapters and then provide a brief summary of each chapter.

Chapter Dependency

For the most part, chapters should be read in sequence, but some variations are possible, especially with the optional chapters. Here's a simplified dependency graph:

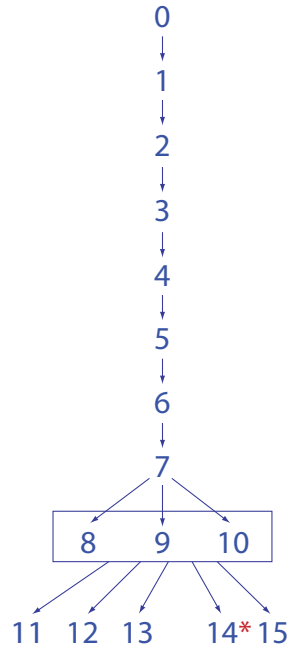

*Note: Some examples use arrays, but the use of arrays is not an integral part of the examples. These examples can be modified to those that do not use arrays. Many topics from the early part of the chapter can be introduced as early as after Chapter 2.

Brief Chapter Summary

Here is a short description of each chapter:

- **Chapter 0** is an optional chapter. We provide background information on computers and programming languages. This chapter can be skipped or assigned as an outside reading if you wish to start with object-oriented programming concepts.
- **Chapter 1** provides a conceptual foundation of object-oriented programming. We describe the key components of object-oriented programming and illustrate each concept with a diagrammatic notation using UML.
- **Chapter 2** covers the basics of Java programming and the process of editing, compiling, and running a program. From the first sample program presented in this chapter, we emphasize object-orientation. We will introduce the standard classes `String`, `Date`, and `SimpleDateFormat` so we can reinforce the notion of object declaration, creation, and usage. Moreover, by using these standard classes, students can immediately start writing practical programs. We describe and illustrate console input with `System.in` and the `Scanner` class and output with `System.out`.
- **Chapter 3** introduces variables, constants, and expressions for manipulating numerical data. We explain the standard `Math` class from `java.lang` and introduce more standard classes (`GregorianCalendar` and `DecimalFormat`) to continually reinforce the notion of object-orientation. We describe additional methods of the `Scanner` class to input numerical values. Random number generation is introduced in this chapter. The optional section explains how the numerical values are represented in memory space.
- **Chapter 4** teaches the basics of creating programmer-defined classes. We keep the chapter accessible by introducing only the fundamentals with illustrative examples. The key topics covered in this chapter are constructors, visibility modifiers (`public` and `private`), local variables, and passing data to methods. We provide easy-to-grasp illustrations that capture the essence of the topics so the students will have a clear understanding of them.
- **Chapter 5** explains the selection statements `if` and `switch`. We cover boolean expressions and nested-`if` statements. We explain how objects are compared by using equivalence (`==`) and equality (the `equals` and `compareTo` methods). We use the `String` and the programmer-defined `Fraction` classes to make the distinction between the equivalence and equality clear. Drawing 2-D graphics is introduced, and a screensaver sample development program is developed. We describe the Java 5.0 feature called *enumerated type* in this chapter.
- **Chapter 6** explains the repetition statements `while`, `do-while`, and `for`. Pitfalls in writing repetition statements are explained. One of the pitfalls to avoid is the use of `float` or `double` for the data type of a counter variable. We illustrate this pitfall by showing a code that will result in infinite loop. Finding the greatest common divisor of two integers is used as an example of a nontrivial loop statement. We show the difference between the straightforward (brute-force) and the clever (Euclid's) solutions. We introduce the `Formatter` class and show

how the output can be aligned nicely. The optional last section of the chapter introduces recursion as another technique for repetition. The recursive version of a method that finds the greatest common divisor of two integers is given.

- **Chapter 7** is the second part of creating programmer-defined classes. We introduce new topics related to the creation of programmer-defined classes and also repeat some of the topics covered in Chapter 4 in more depth. The key topics covered in this chapter are method overloading, the reserved word `this`, class methods and variables, returning an object from a method, and pass-by-value parameter passing. As in Chapter 4, we provide many lucid illustrations to make these topics accessible to beginners. We use the `Fraction` class to illustrate many of these topics, such as the use of `this` and class methods. The complete definition of the `Fraction` class is presented in this chapter.
- **Chapter 8** teaches exception handling and assertions. The focus of this chapter is the construction of reliable programs. We provide a detailed coverage of exception handling in this chapter. We introduce an assertion and show how it can be used to improve the reliability of finished products by catching logical errors early in the development.
- **Chapter 9** covers nonnumerical data types: characters and strings. Both the `String` and `StringBuffer` classes are explained in the chapter. Another string class named `StringBuilder` is briefly explained in this chapter. An important application of string processing is pattern matching. We describe pattern matching and regular expression in this chapter. We introduce the `Pattern` and `Matcher` classes and show how they are used in pattern matching. One section is added to discuss the application of string processing in bioinformatics.
- **Chapter 10** teaches arrays. We cover arrays of primitive data types and of objects. An array is a reference data type in Java, and we show how arrays are passed to methods. We describe how to process two-dimensional arrays and explain that a two-dimensional array is really an array of arrays in Java. Lists and maps are introduced as a more general and flexible way to maintain a collection of data. The use of `ArrayList` and `HashMap` classes from the `java.util` package is shown in the sample programs. Also, we show how the `WordList` helper class used in Chapter 9 sample development program is implemented with another map class called `TreeMap`.
- **Chapter 11** presents searching and sorting algorithms. Both N^2 and $M\log_2 N$ sorting algorithms are covered. The mathematical analysis of searching and sorting algorithms can be omitted depending on the students' background.
- **Chapter 12** explains the file I/O. Standard classes such as `File` and `JFileChooser` are explained. We cover all types of file I/O, from a low-level byte I/O to a high-level object I/O. We show how the file I/O techniques are used to implement the helper classes—`Dorm` and `FileManager`—in Chapter 8 and 9 sample development programs. The use of the `Scanner` class for inputting data from a textfile is also illustrated in this chapter.

- **Chapter 13** discusses inheritance and polymorphism and how to use them effectively in program design. The effect of inheritance for member accessibility and constructors is explained. We also explain the purpose of abstract classes and abstract methods.
- **Chapter 14** covers GUI and event-driven programming. Only the Swing-based GUI components are covered in this chapter. We show how to use the `JOptionPane` class for a very simple GUI-based input and output. GUI components introduced in this chapter include `JButton`, `JLabel`, `ImageIcon`, `JTextField`, `JTextArea`, and menu-related classes. We describe the effective use of nested panels and layout managers. Handling of mouse events is described and illustrated in the sample programs. Those who do not teach GUI can skip this chapter altogether. Those who teach GUI can introduce the beginning part of the chapter as early as after Chapter 2.
- **Chapter 15** covers recursion. Because we want to show the examples where the use of recursion really shines, we did not include any recursive algorithm (other than those used for explanation purposes) that really should be written nonrecursively.

Hallmark Features of the Text

Problem Solving

2.5 Sample Development

Printing the Initials

Now that we have acquired a basic understanding of Java application programs, let's write a new application. We will go through the design, coding, and testing phases of the software life cycle to illustrate the development process. Since the program we develop here is very simple, we can write it without really going through the phases. However, it is extremely important for you to get into a habit of developing a program by following the software life cycle stages. Small programs can be developed in a haphazard manner, but not large programs. We will teach you the development process with small programs first, so you will be ready to use it to create large programs later.

We will develop this program by using an incremental development technique, which will develop the program in small incremental steps. We start out with a bare-bones program and gradually build up the program by adding more and more code to it. At each incremental step, we design, code, and test the program before moving on to the next step. This methodical development of a program allows us to focus our attention on a single task at each step, and this reduces the chance of introducing errors into the program.

Problem Statement

We start our development with a problem statement. The problem statement for our sample programs will be short, ranging from a sentence to a paragraph, but the problem statement for complex and advanced applications may contain many pages. Here's the problem statement for this sample development exercise:

Write an application that asks for the user's first, middle, and last names and replies with the user's initials.

Overall Plan

Our first task is to map out the overall plan for development. We will identify classes necessary for the program and the steps we will follow to implement the program. We begin with the outline of program logic. For a simple program such as this one, it is kind of obvious; but to practice the incremental development, let's put down the outline of program flow explicitly. We can express the program flow as having three tasks:

program tasks

1. Get the user's first, middle, and last names.
2. Extract the initials to formulate the monogram.
3. Output the monogram.

Having identified the three major tasks of the program, we can use to implement the three tasks. First, we get the input. At this point, we have learned about only the `Scanner` class here. Second, we need an object to display the result. Again, it is the only one we know at this point for displaying a

Sample Development Programs

Most chapters include a sample development section that describes the process of incremental development.

Level-by-level Organization for Programming Exercises

Level 1 Programming Exercises ★

5. In the `RollDice` program, we created three `Die` objects and rolled them once. Rewrite the program so you will create only one `Die` object and roll it three times.
6. Write a program that computes the total ticket sales of a concert. There are three types of seatings: A, B, and C. The program accepts the number of tickets sold and the price of a ticket for each of the three types of seats. The total sales are computed as follows:

```
totalSales = numberOfA_Seats * pricePerA_Seat +
             numberOfB_Seats * pricePerB_Seat +
             numberOfC_Seats * pricePerC_Seat;
```

Write this program, using only one class, the main class of the program.

Define a new class named `Temperature`. The class has two accessors—`toFahrenheit` and `toCelsius`—that return the temperature in the specified unit and two mutators—`setFahrenheit` and `setCelsius`—that assign the temperature in the specified unit. Maintain the temperature internally in degrees Fahrenheit. Using this class, write a program that inputs temperature in degrees Fahrenheit and outputs the temperature in equivalent degrees Celsius.

Development Exercises

For the following exercises, use the incremental development methodology to implement the program. For each exercise, identify the program tasks, create a design document with class descriptions, and draw the program diagram. Map out the development steps at the start. Present any design alternatives and justify your selection. Be sure to perform adequate testing at the end of each development step.

11. In the sample development, we developed the user module of the keyless entry system. For this exercise, implement the administrative module that allows the system administrator to add and delete `Resident` objects and modify information on existing `Resident` objects. The module will also allow the user to open a list from a file and save the list to a file. Is it proper to implement the administrative module by using one class? Wouldn't it be a better design if we used multiple classes with each class doing a single, well-defined task?
12. Write an application that maintains the membership lists of five social clubs in a dormitory. The five social clubs are the Computer Science Club, Biology Club, Billiard Club, No Sleep Club, and Wine Tasting Club. Use the `Dorm` class to manage the membership lists. Members of the social clubs are `Resident` objects of the dorm. Use a separate file to store the membership list for each club. Allow the user to add, delete, and modify members of each club.

Development Exercises

give students an opportunity to practice incremental development.

Object-Oriented Approach

We take the object-first approach to teaching object-oriented programming with emphasis on proper object-oriented design. The concept of objects is clearly illustrated from the very first sample program.

```

/*
   Chapter 2 Sample Program: Displaying a Window
   File: Ch2Sample1.java
*/
import javax.swing.*;
class Ch2Sample1 {
    public static void main(String[] args) {
        JFrame myWindow;
        myWindow = new JFrame();
        myWindow.setSize(300, 200);
        myWindow.setTitle("My First Java Program");
        myWindow.setVisible(true);
    }
}

```

Good practices on object-oriented design are discussed throughout the book and illustrated through numerous sample programs.

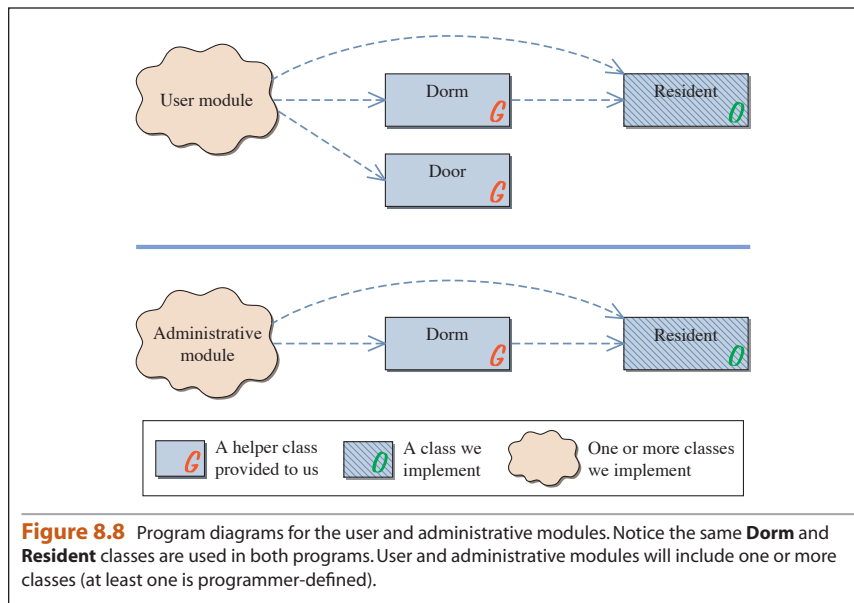

Illustrative Diagrams

Illustrative diagrams are used to explain all key concepts of programming such as the difference between object declaration and creation, the distinction between the primitive data type and the reference data type, the call-by-value parameter passing, inheritance, and many others.

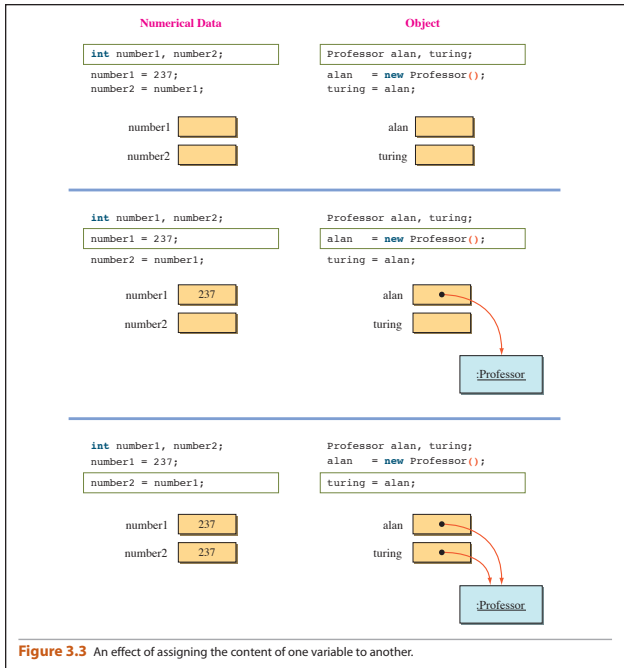

Lucid diagrams are used effectively to explain data structures and abstract data types.

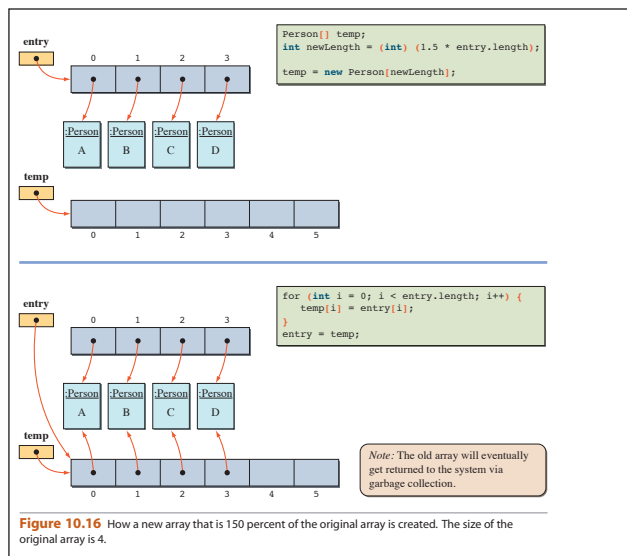

Student Pedagogy

Design Guidelines



Always define a constructor and initialize data members fully in the constructor so an object will be created in a valid state.

Design Guidelines

provide tips on good program design.

Things to Remember

boxes provide tips for students to remember key concepts.

Things to Remember



List the **catch** blocks in the order of specialized to more general exception classes. At most one **catch** block is executed, and all other **catch** blocks are ignored.

Hints, & Tips, & Pitfalls



It is not necessary to create an object for every variable we use. Many novice programmers often make this mistake. For example, we write

```
Fraction f1, f2;
f1 = new Fraction(24, 36);
f2 = f1.simplify();
```

We didn't write

```
Fraction f1, f2;
f1 = new Fraction(24, 36);
f2 = new Fraction(1, 1); //not necessary
f2 = f1.simplify();
```

because it is not necessary. The **simplify** method returns a **Fraction** object, and in the calling program, all we need is a name we can use to refer to this returned **Fraction** object. Don't forget that the object name (variable) and the actual object instance are two separate things.

Tips, Hints, and Pitfalls

provide important points for which to watch out.

You Might Want to Know

boxes give students interesting bits of information.

You Might Want to Know



We can turn our simulation program into a real one by replacing the **Door** class with a class that actually controls the door. Java provides a mechanism called Java Native Interface (JNI) which can be used to embed a link to a low-level device driver code, so calling the **open** method actually unlocks the door.

Quick Check



1. What will be displayed on the console window when the following code is executed and the user enters abc123 and 14?

```
Scanner scanner = new Scanner(System.in);
try {
    int num1 = scanner.nextInt();
    System.out.println("Input 1 accepted");
    int num2 = scanner.nextInt();
    System.out.println("Input 2 accepted");
} catch (InputMismatchException e) {
    System.out.println("Invalid Entry");
}
```

Quick Check

exercises at the end of the sections allow students to test their comprehension of topics.

Supplements for Instructors and Students

The book is supported by a rich array of supplements available through the text's website located at www.mhhe.com/wu

For Instructors, a complete set of PowerPoints, solutions to the chapter exercises, and other resources are provided.

For Students, source code for all example programs, answers to Quick Check exercises, and other resources are provided, as well as the optional galapagos package, which includes the Turtle class that is necessary in solving various chapter exercises.

Acknowledgments

I would like to thank my good friends at McGraw-Hill's editorial and production departments. Needless to say, without their help, this book would not have seen the light of the day. I thank especially Raghu Srinivasan and Lorraine Buczek for their infinite patience.

External reviewers are indispensable in maintaining the accuracy and improving the quality of presentation. Numerous professors have participated as reviewers over the course of five editions, and I thank them all again for their comments, suggestions, and encouragement. I especially thank the reviewers of the Comprehensive edition for their valuable input towards the revision of this fifth edition text.

Personal Story

In September, 2001, I changed my name for personal reasons. Prof. C. Thomas Wu is now Prof. Thomas W. Otani. To maintain continuity and not to confuse people, we continue to publish the book under my former name. For those who care to find out a little about my personal history, they can do so by visiting www.mhhe.com/wu

Introduction to Computers and Programming Languages

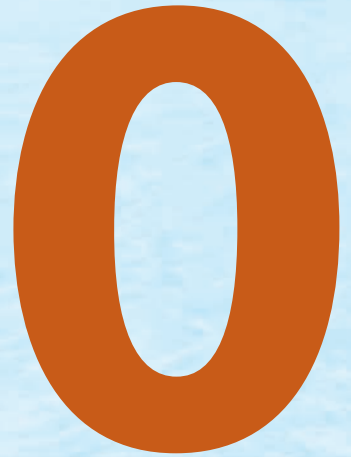

O b j e c t i v e s

After you have read and studied this chapter, you should be able to

- State briefly a history of computers.
- Name and describe five major components of the computer.
- Convert binary numbers to decimal numbers and vice versa.
- State the difference between the low-level and high-level programming languages.

Introduction



B

efore we embark on our study of computer programming, we will present some background information on computers and programming languages in this optional chapter. We provide a brief history of computers from the early days to present and describe the components found in today's computers. We also present a brief history of programming languages from low-level machine languages to today's object-oriented languages.

0.1 | A History of Computers

Humans have evolved from a primitive to a highly advanced society by continually inventing tools. Stone tools, gunpowder, wheels, and other inventions have changed the lives of humans dramatically. In recent history, the computer is arguably the most important invention. In today's highly advanced society, computers affect our lives 24 hours a day: Class schedules are formulated by computers, student records are maintained by computers, exams are graded by computers, dorm security systems are monitored by computers, and numerous other functions that affect us are controlled by computers.

Charles
Babbage

Difference
Engine

Although the first true computer was invented in the 1940s, the concept of a computer is actually more than 160 years old. *Charles Babbage* is credited with inventing a precursor to the modern computer. In 1823 he received a grant from the British government to build a mechanical device he called the *Difference Engine*, intended for computing and printing mathematical tables. The device was based on rotating wheels and was operated by a single crank. Unfortunately, the technology of the time was not advanced enough to build the device. He ran into difficulties and eventually abandoned the project.

Analytical
Engine

But an even more grandiose scheme was already with him. In fact, one of the reasons he gave up on the Difference Engine may have been to work on his new concept for a better machine. He called his new device the *Analytical Engine*. This device, too, was never built. His second device also was ahead of its time; the technology did not yet exist to make the device a reality. Although never built, the Analytical Engine was a remarkable achievement because its design was essentially based on the same fundamental principles of the modern computer. One principle that stands out was its programmability. With the Difference Engine, Babbage would have been able to compute only mathematical tables, but with the Analytical Engine he would have been able to compute any calculation by inputting instructions on punch cards. The method of inputting programs to computers on punch cards was actually adopted for real machines and was still in wide use as late as the 1970s.

Ada Lovelace

The Analytical Engine was never built, but a demonstration program was written by *Ada Lovelace*, a daughter of the poet Lord Byron. The programming language *Ada* was named in honor of Lady Lovelace, the first computer programmer.

In the late 1930s John Atanasoff of Iowa State University, with his graduate student Clifford Berry, built the prototype of the first automatic electronic calculator.

MARK I

One innovation of their machine was the use of binary numbers. (We discuss binary numbers in Sec. 0.2.) At around the same time, Howard Aiken of Harvard University was working on the *Automatic Sequence-Controlled Calculator*, known more commonly as **MARK I**, with support from IBM and the U.S. Navy. MARK I was very similar to the Analytical Engine in design and was described as “Babbage’s dream come true.”

ENIAC I

MARK I was an electromechanical computer based on relays. Mechanical relays were not fast enough, and MARK I was quickly replaced by machines based on electronic vacuum tubes. The first completely electronic computer, **ENIAC I** (*Electronic Numerical Integrator And Calculator*), was built at the University of Pennsylvania under the supervision of John W. Mauchly and J. Presper Eckert. Their work was influenced by the work of John Atanasoff.

stored program

ENIAC I was programmed laboriously by plugging wires into a control panel that resembled an old telephone switchboard. Programming took an enormous amount of the engineers’ time, and even making a simple change to a program was a time-consuming effort. While programming activities were going on, the expensive computer sat idle. To improve its productivity, John von Neumann of Princeton University proposed storing programs in the computer’s memory. This **stored program** scheme not only improved computation speed but also allowed far more flexible ways of writing programs. For example, because a program is stored in the memory, the computer can change the program instructions to alter the sequence of the execution, thereby making it possible to get different results from a single program.

generations of computers

We characterized these early computers with vacuum tubes as *first-generation computers*. *Second-generation computers*, with transistors replacing the vacuum tubes, started appearing in the late 1950s. Improvements in memory devices also increased processing speed further. In the early 1960s, transistors were replaced by integrated circuits, and *third-generation computers* emerged. A single integrated circuit of this period incorporated hundreds of transistors and made the construction of minicomputers possible. Minicomputers are small enough to be placed on desktops in individual offices and labs. The early computers, on the other hand, were so huge that they easily occupied the whole basement of a large building.

Advancement of integrated circuits was phenomenal. Large-scale integrated circuits, commonly known as *computer chips* or *silicon chips*, packed the power equivalent to thousands of transistors and made the notion of a “computer on a single chip” a reality. With large-scale integrated circuits, *microcomputers* emerged in the mid-1970s. The machines we call *personal computers* today are descendants of the microcomputers of the 1970s. The computer chips used in today’s personal computers pack the power equivalent to several millions of transistors. Personal computers are *fourth-generation computers*.

Early microcomputers were isolated, stand-alone machines. The word *personal* describes a machine as a personal device intended to be used by an individual. However, it did not take long to realize there was a need to share computer resources. For example, early microcomputers required a dedicated printer. Wouldn’t it make more sense to have many computers share a single printer? Wouldn’t it also make sense to share data among computers, instead of duplicating the same data on

network

LAN

WAN

internet

individual machines? Wouldn't it be nice to send electronic messages between the computers? The notion of networked computers arose to meet these needs.

Computers of all kinds are connected into a *network*. A network that connects computers in a single building or in several nearby buildings is called a *local-area network* or *LAN*. A network that connects geographically dispersed computers is called a *wide-area network* or *WAN*. These individual networks can be connected further to form interconnected networks called *internets*. The most famous internet is simply called the *Internet*. The Internet makes the sharing of worldwide information possible and easy. The hottest tool for viewing information on the Internet is a *Web browser*. A Web browser allows you to experience *multimedia information* consisting of text, audio, video, and other types of information. We will describe how Java is related to the Internet and Web browsers in Section 0.4.



If you want to learn more about the history of computing, there is a wealth of information available on the Web. You can start your exploration from

www.yahoo.com/Computers_and_Internet/History

For more information on the pioneers of computers, visit

en.wikipedia.org/wiki/category:Computer_pioneers



1. Who was the first computer programmer?
2. Who designed the Difference Engine and Analytical Engine?
3. How many generations of computers are there?

0.2 Computer Architecture

A typical computer today has five basic components: RAM, CPU, storage devices, I/O (input/output) devices, and communication devices. Figure 0.1 illustrates these five components. Before we describe the components of a computer, we will explain the binary number system used in a computer.

Binary Numbers

To understand the binary number system, let's first review the decimal number system in which we use 10 digits: 0, 1, 2, 3, 4, 5, 6, 7, 8, 9. To represent a number in the decimal system, we use a sequence of one or more of these digits. The value that each digit in the sequence represents depends on its position. For example, consider the numbers 234 and 324. The digit 2 in the first number represents 200, whereas the digit 2 in the second number represents 20. A position in a sequence has a value that is an integral power of 10. The following diagram illustrates how the

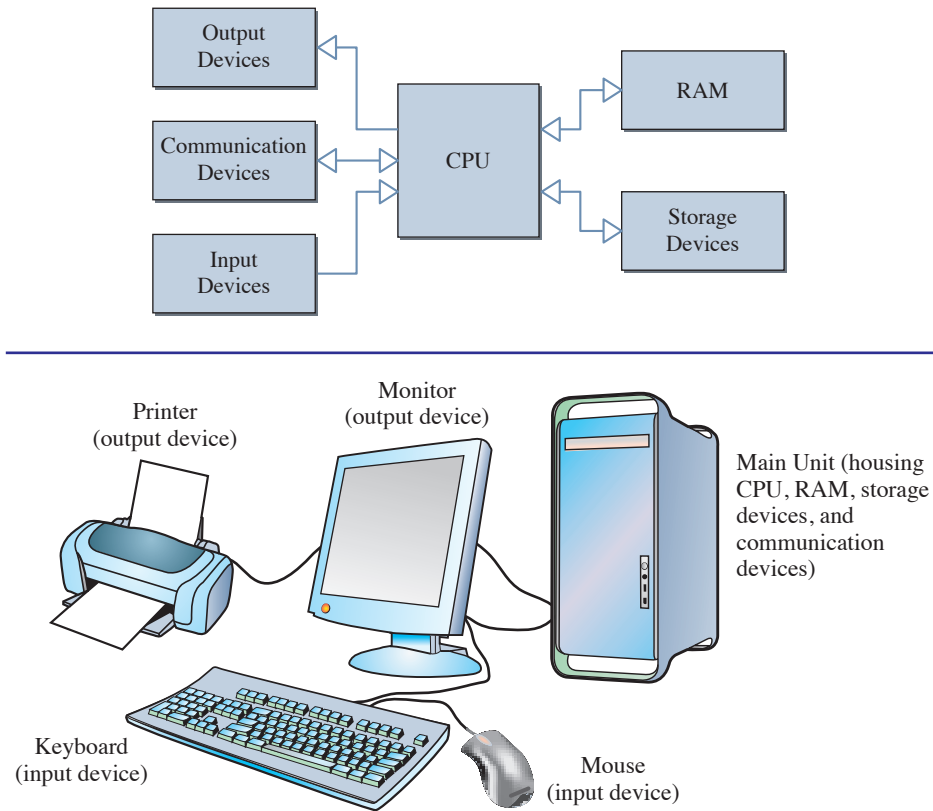
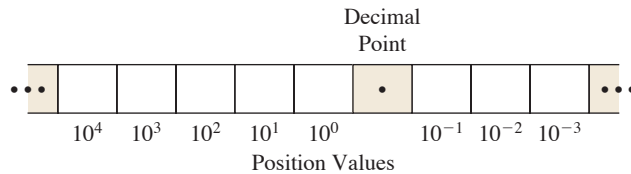

Figure 0.1 A simplified view of an architecture for a typical computer.

values of positions are determined:



The value of a decimal number (represented as a sequence of digits) is the sum of the digits, multiplied by their position values, as illustrated:

2	4	8	•	7
10^2	10^1	10^0		10^{-1}

$$\begin{aligned}
 &= 2 \times 10^2 + 4 \times 10^1 + 8 \times 10^0 + 7 \times 10^{-1} \\
 &= 2 \times 100 + 4 \times 10 + 8 \times 1 + 7 \times 1/10 \\
 &= 200 + 40 + 8 + 7/10 = 248.7
 \end{aligned}$$

base-2 numbers

binary number

bits

In the decimal number system, we have 10 symbols, and the position values are integral powers of 10. We say that 10 is the *base* or *radix* of the decimal number system. The *binary number* system works the same as the decimal number system but uses 2 as its base. The binary number system has two digits (0 and 1) called *bits*, and position values are integral powers of 2. The following diagram illustrates how the values of positions are determined in the binary system:

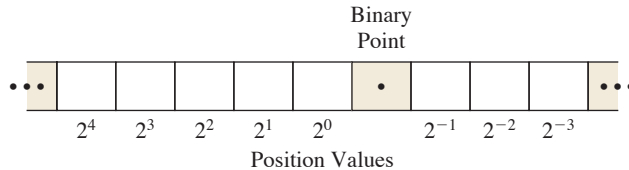

The value of a binary number (represented as a sequence of bits) is the sum of the bits, multiplied by their position values, as illustrated:

1	0	1	•	1
2^2	2^1	2^0		2^{-1}

$$\begin{aligned}
 &= 1 \times 2^2 + 0 \times 2^1 + 1 \times 2^0 + 1 \times 2^{-1} \\
 &= 1 \times 4 + 0 \times 2 + 1 \times 1 + 1 \times 1/2 \\
 &= 4 + 0 + 1 + 1/2 = 5.5
 \end{aligned}$$

binary-to-decimal conversion

So the binary number 101.1 is numerically equivalent to the decimal number 5.5. This illustration shows how to convert a given binary number to the decimal equivalent. How about converting a given decimal number to its binary equivalent?

The following steps show how to convert a decimal number (only the whole numbers) to the equivalent binary number. The basic idea goes something like this:

decimal-to-binary conversion

1. Divide the number by 2.
2. The remainder is the bit value of the 2^0 position.
3. Divide the quotient by 2.
4. The remainder is the bit value of the 2^1 position.
5. Divide the quotient by 2.
6. The remainder is the bit value of the 2^2 position.
7. Repeat the procedure until you cannot divide any further, that is, until the quotient becomes 0.

The following diagram illustrates the conversion of decimal number 25.

Division #5	Division #4	Division #3	Division #2	Division #1	
$\begin{array}{r} 0 \\ 2 \overline{) 1} \\ \hline 0 \\ \hline \mathbf{1} \end{array}$	$\begin{array}{r} 1 \\ 2 \overline{) 3} \\ \hline 2 \\ \hline \mathbf{1} \end{array}$	$\begin{array}{r} 3 \\ 2 \overline{) 6} \\ \hline 6 \\ \hline \mathbf{0} \end{array}$	$\begin{array}{r} 6 \\ 2 \overline{) 12} \\ \hline 12 \\ \hline \mathbf{0} \end{array}$	$\begin{array}{r} 12 \\ 2 \overline{) 25} \\ \hline 24 \\ \hline \mathbf{1} \end{array}$	
2^4	2^3	2^2	2^1	2^0	
16	+	8	+	0	+
		0	+	0	+
				1	= 25

The binary system is more suitable for computers than the decimal system because it is far easier to design an electrical device that can distinguish two states (bits 0 and 1) than 10 states (digits 0 through 9). For example, we can represent 1 by turning the switch on and 0 by turning the switch off. In a real computer, 0 is represented by electrical voltage below a certain level and 1 by electrical voltage at or above this level.

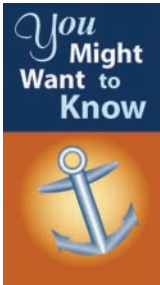

When you pay closer attention to the on/off switch on computers and other electronic devices, you should notice an icon like this



This is a stylized representation of binary digits 0 and 1.

RAM

RAM

byte

Random access memory or **RAM** is a repository for both program instructions and data manipulated by the program during execution. RAM is divided into *cells*, with each cell having a unique address. Typically, each cell consists of 4 *bytes* (B), and a single byte (1 B) in turn consists of 8 *bits*. Each bit, which can be either on or off, represents a single binary digit. RAM is measured by the number of bytes it contains. For example, 128 kilobytes (KB) of RAM contains $128 \times 1024 = 131,072$ B because 1 KB is equal to $2^{10} = 1024$ B. Notice that 1 K is not equal to 10^3 , although $10^3 = 1000$ is a close approximation to $2^{10} = 1024$. The first IBM PC introduced in 1981 came with 16 KB of RAM, and the first Macintosh computer introduced in 1984 came with 128 KB of RAM. In contrast, a typical PC today has anywhere from 1GB (gigabytes) to 4GB of RAM. Given that 1GB is equal to 1024 MB (megabytes) and 1 MB is equal to 1024 KB, we know that 2GB means $2 \times 1024 \text{ MB} = 2048 \text{ MB} = 2048 \times 1024 \text{ KB} = 2,097,152 \text{ KB} = 2,097,152 \times 1024 \text{ B} = 2,147,483,648 \text{ B}$.

CPU

CPU

The *central processing unit* or **CPU** is the brain of a computer. The CPU is the component that executes program instructions by fetching an instruction (stored in RAM), executing it, fetching the next instruction, executing it, and so on until it encounters an instruction to stop. The CPU contains a small number of **registers**, which are high-speed devices for storing data or instructions temporarily. The CPU also contains the *arithmetic-logic unit* (ALU), which performs arithmetic operations such as addition and subtraction and logical operations such as comparing two numbers.

register

clock speed

CPU's are characterized by their **clock speeds**. For example, in the Intel Pentium 200, the CPU has a clock speed of 200 megahertz (MHz). The *hertz* is a unit of frequency equal to 1 cycle per second. A *cycle* is a period of time between two on states or off states. So 200 MHz equals 200,000,000 cycles per second. The fastest CPU for commercially available personal computers was around 200 MHz in 1997 when the first edition of this textbook was published. But by the beginning of 1998, many vendors started selling 300-MHz machines. And in a mere 6 months, by the middle of 1998, the top-of-the-line personal computers were 400-MHz machines. As of this writing in late 2008, we see computers with 2.93-GHz (2930-MHz) CPU being advertised and sold. The increase of the CPU speed in the last two decades is truly astonishing. The clock speed of the Intel 8080, the CPU introduced in 1974 that started the PC revolution, was a mere 2 MHz. In contrast, the clock speed of the Intel Pentium 4 introduced in 2001 was 2 GHz (2000 MHz). Table 0.1 lists some of the Intel processors.

I/O Devices

I/O devices

Input/output or **I/O devices** allow communication between the user and the CPU. Input devices such as keyboards and mice are used to enter data, programs, and commands in the CPU. Output devices such as monitors and printers are used to display or print information. Other I/O devices include scanners, bar code readers, magnetic strip readers, digital video cameras, and musical instrument digital interface (MIDI) devices.

Storage Devices

nonvolatile and volatile memory

Storage devices such as disk and tape drives are used to store data and programs. Secondary storage devices are called **nonvolatile memory**, while RAM is called **volatile memory**. *Volatile* means the data stored in a device will be lost when the power to the device is turned off. Being nonvolatile and much cheaper than RAM, secondary storage is an ideal medium for permanent storage of large volumes of data. A secondary storage device cannot replace RAM, though, because secondary storage is far slower in data access (getting data out and writing data in) compared to RAM.

The most common storage device today for personal computers is a disk drive. There are two kinds of disks: hard and floppy (also known as diskettes). Hard disks provide much faster performance and larger capacity, but are normally not removable; that is, a single hard disk is permanently attached to a disk drive. Floppy disks, on the other hand, are removable, but their performance is far slower and their capacity far smaller than those of hard disks. As the standard floppy disks can

Table 0.1

A table of Intel processors. For some CPUs, several types with different clock speeds are possible. In such case, only the fastest clock speed is shown. For more information on Intel CPUs, visit <http://www.intel.com>.

	CPU	Date Introduced	Clock Speed (MHz)
1970s	4004	11/15/71	0.108
	8008	4/1/72	0.200
	8080	4/1/74	2
	8088	6/1/79	8
1980s	80286	2/1/82	12
	80386SX	6/16/88	16
	80486DX	4/10/89	25
1990s	Pentium	3/22/93	66
	Pentium Pro	11/1/95	200
	Pentium II	5/7/97	300
	Pentium II Xeon	6/29/98	400
	Pentium III	10/25/99	733
2000s	Xeon	9/25/01	2000
	Pentium 4	4/27/01	2000
	Itanium 2	7/8/02	1000
	Pentium 4 Extreme Edition	2/2/04	3400
	Core 2 Extreme	7/27/06	3200

store only up to approximately 1.44 MB, they are becoming less useful in today's world of multimegabyte image and sound files. They are fast becoming obsolete, and hardly anybody uses them anymore. Removable storage media with much higher capacity such as zip disks (capable of holding 100 to 250 MB of data) replaced floppy disks in late 1990s. Computer technology moves so quickly that zip disks themselves are already becoming obsolete. The most common form of portable storage medium today (2008) is a compact USB flash drive, also known as a thumb drive, whose capacity ranges from 125 MB to 16 GB.

Hard disks can store a huge amount of data, typically ranging from 160 GB (gigabyte; 1 GB = 1024 MB) to 500 GB for a standard desktop PC in 2008. Portable and removable hard disk drives, with performance and capacity that rival those of nonremovable hard disks, are also available, but their use is not widespread.

Compact disks (CDs) are commonly used for storing massive amounts of data, approximately 700 MB. Many software packages we buy today—computer games,

word processors, and others—come with a single CD. Before the CD became a popular storage device for computers, some software packages came with more than 20 floppy diskettes. Because of the massive storage capacity of the CD, most computer vendors eliminated printed manuals altogether by putting the manuals on the CD.

You
Might
Want to
Know



Many companies, in addition to CD or in lieu of, provide “boxless” online distribution of software. With this scheme, we buy and download the software directly to our computers from the company websites. From some book publishers, especially in the professional market, we can even buy an online version of their books. The online version is most commonly downloaded as a single file stored in the *Portable Document Format* (PDF) format.

communication
device

Communication Devices

A *communication device* connects the personal computer to an internet. The traditional communication device for computers at home and in small offices was the *modem*. A modem, which stands for *modulator-demodulator*, is a device that converts analog signals to digital and digital signals to analog. By using a modem, a computer can send to and receive data from another computer over the phone line. The most critical characteristic of a modem is its transmission speed, which is measured in *bits per second* (bps). A typical speed for a modem is 56,000 bps, commonly called a 56K modem. Under an ideal condition (no line noise or congestion), a 56K modem can transfer a 1 MB file in about 2½ minutes. Frequently, though, the actual transfer rate is much lower than the possible maximum. So-called DSL and cable modems are not truly modems because they transfer data strictly in digital mode, which allows for much faster connection speeds of 144K or above. High-speed satellite connection to the Internet is also available today.

A communication device for connecting a computer to a LAN is a *network interface card* (NIC). A NIC can transfer data at a much faster rate than the fastest modem. For instance, a type of NIC called *10BaseT* can transfer data at the rate of 10 Mbps over the network. Traditional networks are connected, or wired, by the cables. Increasingly, networks are connected wirelessly, where data are carried over radio waves. Wireless networking is called WiFi or 802.11 networking. Today you will find wireless networking almost universally available at airports, hotels, and universities.

Quick
CHECK
✓

1. Name five major components of a computer.
2. What is the difference between volatile and nonvolatile memory?
3. What does the acronym *CPU* stand for?
4. How many bytes does the 64 KB RAM have?
5. Which device connects a computer to the Internet using a phone line?

0.3 | Programming Languages

machine language

Programming languages are broadly classified into three levels: machine languages, assembly languages, and high-level languages. *Machine language* is the only programming language the CPU understands. Each type of CPU has its own machine language. For example, the Intel Pentium and Motorola PowerPC understand different machine languages. Machine-language instructions are binary-coded and very low level—one machine instruction may transfer the contents of one memory location into a CPU register or add numbers in two registers. Thus, we must provide many machine-language instructions to accomplish a simple task such as finding the average of 20 numbers. A program written in machine language might look like this:

machine code

```
10110011 00011001
01111010 11010001 10010100
10011111 00011001
01011100 11010001 10010000
10111011 11010001 10010110
```

assembly language

One level above machine language is *assembly language*, which allows “higher-level” symbolic programming. Instead of writing programs as a sequence of bits, assembly language allows programmers to write programs by using symbolic operation codes. For example, instead of 10110011, we use MV to move the contents of a memory cell into a register. We also can use symbolic, or mnemonic, names for registers and memory cells. A program written in assembly language might look like this:

assembly code

```
MV 0, SUM
MV NUM, AC
ADD SUM, AC
STO SUM, TOT
```

assembler

Since programs written in assembly language are not recognized by the CPU, we use an *assembler* to translate programs written in assembly language into machine-language equivalents. Compared to writing programs in machine language, writing programs in assembly language is much faster, but not fast enough for writing complex programs.

high-level languages

High-level languages were developed to enable programmers to write programs faster than when using assembly languages. For example, FORTRAN (FORmula TRANslator), a programming language intended for mathematical computation, allows programmers to express numerical equations directly as

high-level code

$$X = (Y + Z) / 2$$

COBOL (COmmon Business-Oriented Language) is a programming language intended for business data processing applications. FORTRAN and COBOL were developed in the late 1950s and early 1960s and are still in use. BASIC (Beginners All-purpose Symbolic Instructional Code) was developed specifically as an easy language for students to learn and use. BASIC was the first high-level language

compiler

available for microcomputers. Another famous high-level language is Pascal, which was designed as an academic language. Since programs written in a high-level language are not recognized by the CPU, we must use a *compiler* to translate them to assembly language equivalents.

The programming language C was developed in the early 1970s at AT&T Bell Labs. The C++ programming language was developed as a successor of C in the early 1980s to add support for object-oriented programming. Object-oriented programming is a style of programming gaining wider acceptance today. Although the concept of object-oriented programming is old (the first object-oriented programming language, Simula, was developed in the late 1960s), its significance wasn't realized until the early 1980s. Smalltalk, developed at Xerox PARC, is another well-known object-oriented programming language. The programming language we use in this book is Java, the newest object-oriented programming language, developed at Sun Microsystems.

0.4 | Java

Java

Java is a new object-oriented language that is receiving wide attention from both industry and academia. Java was developed by James Gosling and his team at Sun Microsystems in California. The language was based on C and C++ and was originally intended for writing programs that control consumer appliances such as toasters, microwave ovens, and others. The language was first called Oak, named after the oak tree outside of Gosling's office, but the name was already taken, so the team renamed it Java.

applet

Java is often described as a *Web programming language* because of its use in writing programs called *applets* that run within a Web browser. That is, you need a Web browser to execute Java applets. Applets allow more dynamic and flexible dissemination of information on the Internet, and this feature alone makes Java an attractive language to learn. However, we are not limited to writing applets in Java. We can write Java applications also. A Java *application* is a complete stand-alone program that does not require a Web browser. A Java application is analogous to a program we write in other programming languages. In this book, we describe Java applications only because our objective is to teach the fundamentals of object-oriented programming that are applicable to all object-oriented programming languages.

application

We chose Java for this textbook mainly for its clean design. The language designers of Java took a minimalist approach; they included only features that are indispensable and eliminated features that they considered excessive or redundant. This minimalist approach makes Java a much easier language to learn than other object-oriented programming languages. Java is an ideal vehicle for teaching the fundamentals of object-oriented programming. All the sample programs in this book are tested against the newest version, Java 6.0.

Summary

- Charles Babbage invented the Difference Engine and Analytical Engine, precursors to the modern computer.
- Ada Lovelace is considered the first computer programmer.

- The first two modern computers were MARK I and ENIAC I.
- John von Neumann invented the stored-program approach of executing programs.
- Computers are connected into a network. Interconnected networks are called internets.
- Binary numbers are used in computers.
- A typical computer consists of five components: RAM, CPU, storage devices, I/O devices, and communication devices.
- There are three levels of programming languages: machine, assembly, and high-level.
- Java is one of the newest high-level programming languages in use today. This textbook teaches how to program using Java.

Key Concepts

network	binary numbers
LAN	binary-to-decimal conversion
WAN	machine language
internets and Internet	assembly language
CPU	assembler
RAM	high-level language
I/O devices	compiler
communication devices	Java

Chapter 0 Exercises

Review Exercises

1. Visit your school's computer lab or a computer store, and identify the different components of the computers you see. Do you notice any unique input or output devices?
2. Visit your school's computer lab and find out the CPU speed, RAM size, and hard disk capacity of its computers.
3. Convert these binary numbers to decimal numbers.
 - a. 1010
 - b. 110011
 - c. 110.01
 - d. 111111

4. Convert these decimal numbers to binary numbers.
 - a. 35
 - b. 125
 - c. 567
 - d. 98
5. What is the maximum decimal number you can represent in 4 bits? 16 bits? N bits?
6. If a computer has 128 MB of RAM, how many bytes are there?
7. How do high-level programming languages differ from low-level programming languages?
8. Consider a hypothetical programming language called *Kona*. Using Kona, you can write a program to compute and print out the sum of 20 integers entered by the user:

```
let sum = 0;
repeat 20 times [
  let x = next input;
  add x to sum;
]
printout sum;
```

Is Kona a high-level language? Why or why not?

Introduction to Object-Oriented Programming and Software Development



O b j e c t i v e s

After you have read and studied this chapter, you should be able to

- Name the basic components of object-oriented programming.
- Differentiate classes and objects.
- Differentiate class and instance methods.
- Differentiate class and instance data values.
- Draw program diagrams using icons for classes, objects, and other components of object-oriented programming.
- Describe the significance of inheritance in object-oriented programs.
- Name and explain the stages of the software life cycle.

Introduction



B

object-oriented programming

efore we begin to write actual programs, we need to introduce a few basic concepts of *object-oriented programming* (OOP), the style of programming we teach in this book. The purpose of this chapter is to give you a feel for object-oriented programming and to introduce a conceptual foundation of object-oriented programming. You may want to refer to this chapter as you progress through the book. What we discuss in the next four sections is independent of any particular programming language.

Another purpose of this chapter is to introduce the software development process. To be able to write programs, knowledge of the components of object-oriented programs is not enough. We must learn the process of developing programs. We will present a brief introduction to the software development process in this chapter.

1.1 Classes and Objects

object

The two most important concepts in object-oriented programming are the class and the object. In the broadest term, an *object* is a thing, both tangible and intangible, that we can imagine. A program written in object-oriented style will consist of interacting objects. For a program to keep track of student residents of a college dormitory, we may have many Student, Room, and Floor objects. For another program to keep track of customers and inventory for a bicycle shop, we may have Customer, Bicycle, and many other types of objects. An object is comprised of data and operations that manipulate these data. For example, a Student object may consist of data such as name, gender, birth date, home address, phone number, and age and operations for assigning and changing these data values. We will use the notation shown in Figure 1.1 throughout the book to represent an object. The notation we used in the book is based on the industry standard notation called *UML*, which stands for Unified Modeling Language. In some of the illustrations, we relax the rules of UML slightly for pedagogy.

Almost all nontrivial programs will have many objects of the same type. For example, in the bicycle shop program we expect to see many Bicycle and other

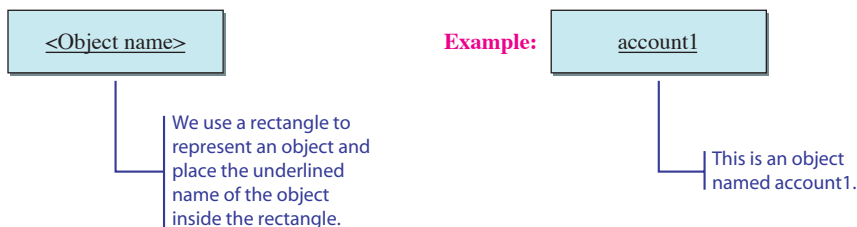

Figure 1.1 A graphical representation of an object.

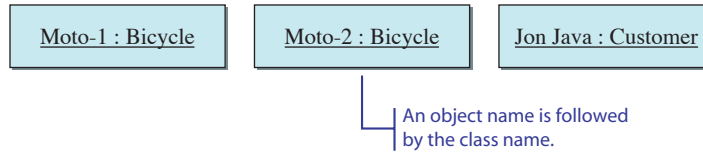

Figure 1.2 Two Bicycle objects with the names Moto-1 and Moto-2 and one Customer object with the name Jon Java.

objects. Figure 1.2 shows two Bicycle objects with the names Moto-1 and Moto-2 and one Customer object with the name Jon Java.

Inside a program we write instructions to create objects. For the computer to be able to create an object, we must provide a definition, called a *class*. A class is a kind of mold or template that dictates what objects can and cannot do. An object is called an *instance* of a class. An object is an instance of exactly one class. An instance of a class *belongs to* the class. The two Bicycle objects Moto-1 and Moto-2 are instances of the Bicycle class. Once a class is defined, we can create as many instances of the class as a program requires.

class

instance

Things to Remember



A class must be defined before you can create an instance (object) of the class.

Figure 1.3 shows a diagram that we will use throughout the book to represent a class.

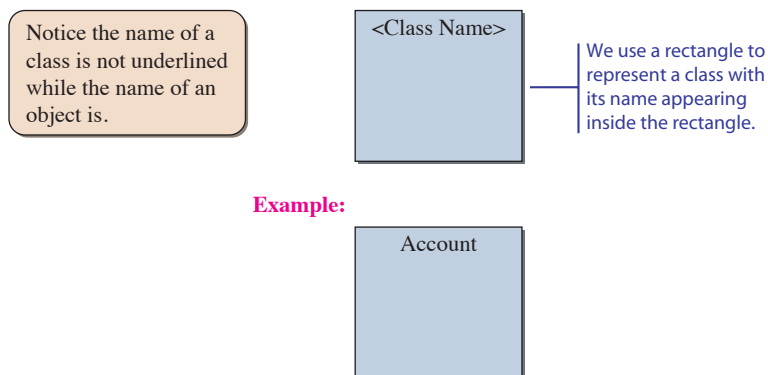

Figure 1.3 A graphical representation of a class.



1. Draw an object diagram for a Person class and two Person objects, Ms. Latte and Mr. Espresso.
2. What must be defined before you can create an object?



Many beginning programmers may not see the distinction between the class and object as clearly as the more experienced programmers do. It may be helpful to compare the class and object to a woodcut and the prints produced from the woodcut. A woodcut is a block of wood engraved with a design for printing. Once you have a woodcut, you can make as many prints as you wish. Similarly, once you have a class, you can make as many objects from the class. Also, just as you cannot make prints without having a woodcut, you cannot create an object without first defining a class. For sample prints by the 19th-century Japanese artist Hiroshige, visit

<http://www.ibiblio.org/wm/paint/auth/hiroshige/>

1.2 Messages and Methods

In writing object-oriented programs we must first define classes, and while the program is running, we use the classes and objects from these classes to accomplish tasks. A task can range from adding two numbers, to computing an interest payment for a college loan, to calculating the reentry angle of a space shuttle. To instruct a class or an object to perform a task, we send a *message* to it. For example, we send a message deposit to an Account object to deposit \$100.

For a class or an object to process the message, it must be programmed accordingly. You cannot just send a message to any class or object. You can send a message only to the classes and objects that understand the message you send. For a class or an object to process the message it receives, it must possess a matching *method*, which is a sequence of instructions that a class or an object follows to perform a task. A method defined for a class is called a *class method*, and a method defined for an object is an *instance method*.

Let's look at an example of an instance method first. Suppose a method called walk is defined for a Robot object and instructs the robot to walk a designated distance. With this method defined, we can send the message walk to a Robot object, along with the distance to be walked. A value we pass to an object is called an *argument* of a message. Notice that the name of the message we send to an object or a class must be the same as the method's name. In Figure 1.4 we represent the sending of a message.

message

method

class and
instance
methods

argument

The diagram in Figure 1.4 illustrates one-way communication; that is, an object carries out the requested operation (it walks the designated distance) but does not respond to the message sender. In many situations, we need a reply in which an object responds by returning a value to the message sender. For example, suppose we want to know the distance from a robot to its nearest obstacle. The designer of a robot may include a method `getObstacleDistance` that returns the desired value. The diagram in Figure 1.5 shows a method that returns a value to the message sender. Instead of returning a numerical value, a method can report back the status of the requested operation. For example, a method `walk` can be defined to return the status `success/fail` to indicate whether the specified distance was covered successfully or not (e.g., it fails when the robot bumps into an obstacle).

Now let's look at an example of class methods. The class method `getMaximumSpeed` shown in Figure 1.6 returns the maximum possible speed of all `Robot` objects. A method such as `getMaximumSpeed` that deals with collective information about the instances of a class is usually defined as a class method. So we define an instance method for a task that pertains to an individual instance and a class method for a task that pertains to all instances.

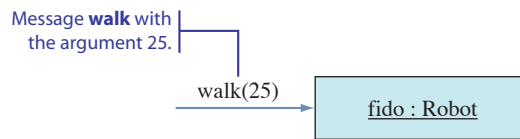

Figure 1.4 Sending the message `walk` to a `Robot` object.

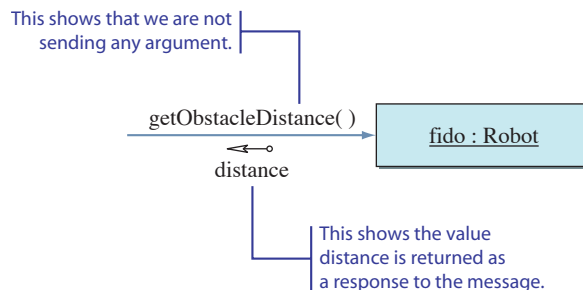

Figure 1.5 The result `distance` is returned to the sender of the message.

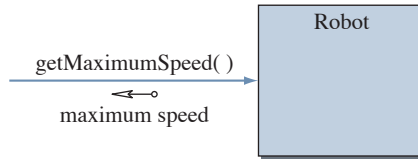

Figure 1.6 The maximum possible speed of all **Robot** objects is returned by the class method **getMaximumSpeed**.



1. Draw an object diagram of an Account object with instance methods deposit and withdraw.
2. Is the getObstacleDistance method an instance or a class method?

1.3 Class and Instance Data Values

Suppose the method deposit of an Account object instructs the object to add a given amount to the current balance. Where does the object keep the current balance? Remember that an object is comprised of data values and methods. Analogous to defining class and instance methods, we can define class and instance data values. For example, we define an *instance data value* current balance for Account objects to record the current balance. Figure 1.7 shows three Account objects with their data values current balance. Notice that they all have the same data value current balance. All instances of the same class will possess the same set of data values. The actual dollar amounts for current balance, as the diagram illustrates, differ from one instance to another. Items such as opening balance and account number are other possible instance data values for Account objects.

instance data value

class data value

A *class data value* is used to represent information shared by all instances or to represent collective information about the instances. For example, if every account must maintain a minimum balance of, say, \$100, we can define a class data value minimum balance. An instance can access the class data values of the class to which it belongs, so every Account object can access the class data value minimum balance.

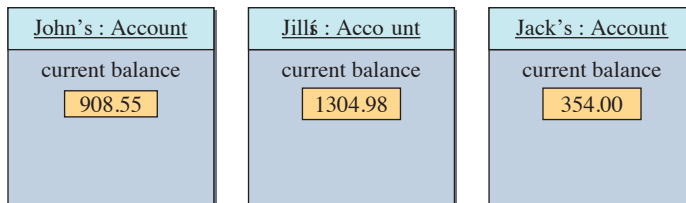

Figure 1.7 Three **Account** objects possess the same data value **current balance**, but the actual dollar amounts differ.

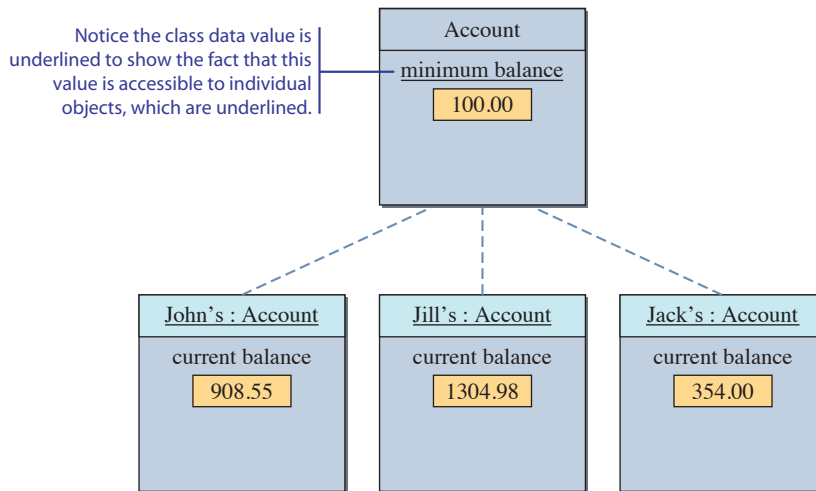

Figure 1.8 Three **Account** objects sharing information (**minimum balance** = \$100) stored as a class data value.

Figure 1.8 shows how we represent a class data value. Notice that we underline the class data value. Because the objects of a class are underlined, and the class data values are accessible to all objects of the class, we likewise underline the class data value to show this relationship. Data values are also called *data members* because they belong to a class or instance of the class.

data member

To appreciate the significance of a class data value, let's see what happens if we represent minimum balance as an instance data value. Figure 1.9 shows three **Account** objects having different dollar amounts for the current balance but the same dollar amount for the minimum balance. Obviously, this duplication of minimum balance is redundant and wastes space. Consider, for example, what happens if the bank raises the minimum balance to \$200. If there are 100 **Account** objects, then all 100 copies of minimum balance must be updated. We can avoid this by defining minimum balance as a class data value. Figure 1.10 shows another example where the opening and closing times are shared by all cafeterias on campus.

variable

There are two types of data values: those that can change over time and those that cannot. A data value that can change is called a *variable*, and one that cannot

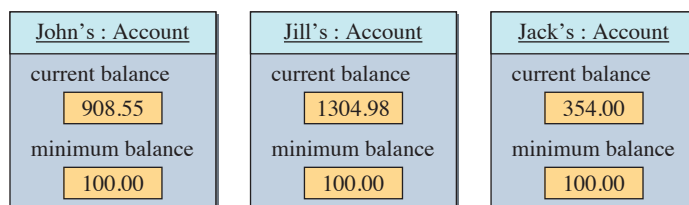

Figure 1.9 Three **Account** objects duplicating information (**minimum balance** = \$100) in instance data values.

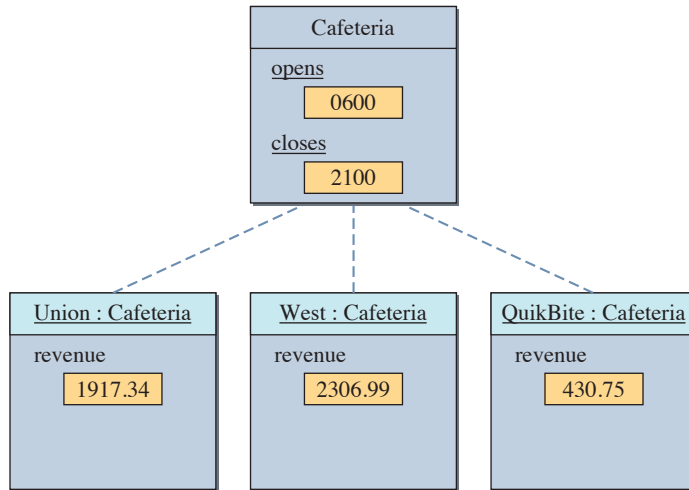

Figure 1.10 Three **Cafeteria** objects sharing the same opening and closing times, stored as class data values.

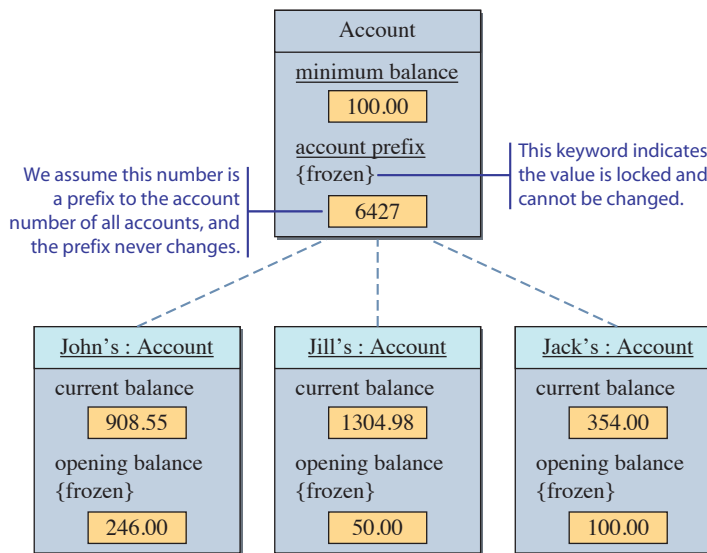

Figure 1.11 Graphical representations for four types of data values: class variable, class constant, instance variable, and instance constant.

constant

change is a *constant*. Figure 1.11 illustrates how we represent and distinguish between variables and constants. We use the keyword `frozen` for constants to indicate that they cannot change. Notice that we now have four kinds of data values: class variables, class constants, instance variables, and instance constants.

Quick CHECK



1. What is the difference between a constant and a variable?
2. Draw an object diagram of a **Person** object with the three instance variables name, age, and gender.

1.4 | Inheritance

When we used the **Account** class and its instances to illustrate object-oriented concepts, some of you were probably thinking about checking accounts, while others may have been thinking about savings accounts. We did not distinguish between the two in the examples. But when we look at the problem a little more carefully, we will realize that in fact these two types of accounts are different, even though they share many features.

In general, using only a single class to model two or more entities that are similar but different is not good design. In object-oriented programming, we use a mechanism called *inheritance* to design two or more entities that are different but share many common features. First we define a class that contains the common features of the entities. Then we define classes as an extension of the common class inheriting everything from the common class. We call the common class the *superclass* and all classes that inherit from it *subclasses*. We also call the superclass an *ancestor* and the subclass a *descendant*. Other names for superclass and subclass are *base class* and *derived class*, respectively. For the bank example, we can define a superclass **Account** and then define **Savings** and **Checking** as subclasses of **Account**. We represent the superclass and its subclasses as shown in Figure 1.12. Notice that we draw arrows from each subclass to its superclass because a subclass can refer to items defined in its superclass, but not vice versa.

Inheritance is not limited to one level. A subclass can be a superclass of other classes, forming an inheritance hierarchy. Consider the example shown in Figure 1.13.

inheritance

superclass and
subclass

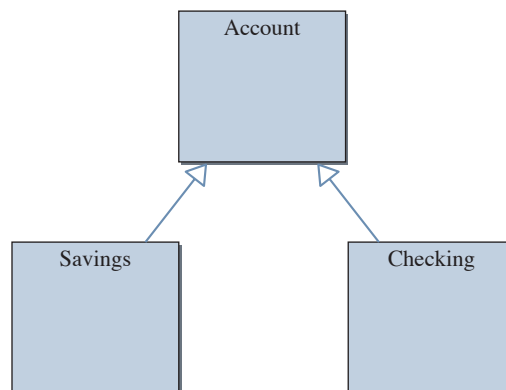

Figure 1.12 A superclass **Account** and its subclasses **Savings** and **Checking**.

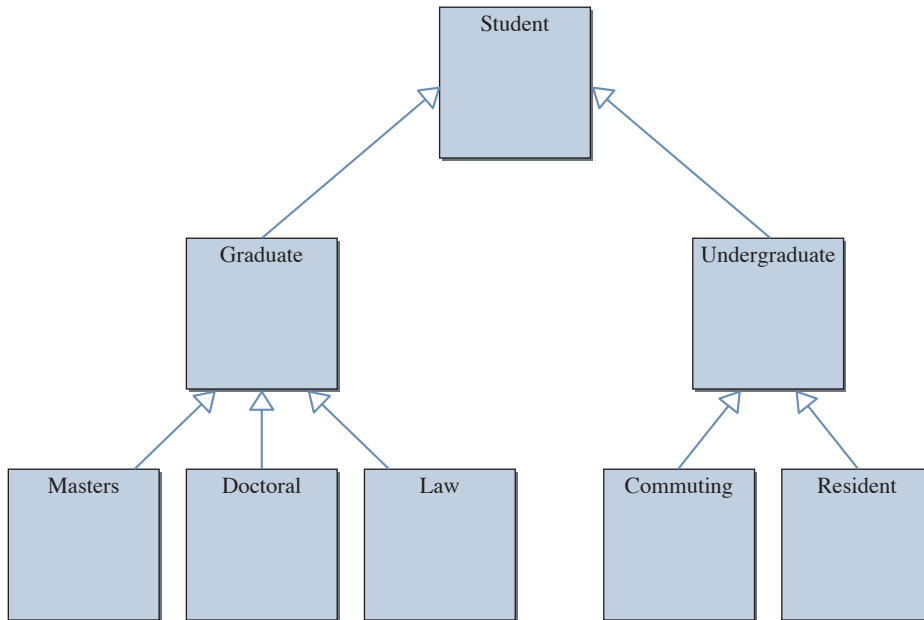

Figure 1.13 An example of inheritance hierarchy among different types of students.

Inheritance is very powerful, and if it is used properly, we can develop complex programs very efficiently and elegantly. The flip side of using a very powerful tool is that if we do not use it correctly, we could end up in a far worse situation than if we did not use it. We will be seeing many examples of inheritance throughout this book. In Chapter 2, for example, we will introduce many classes that come with the Java system. Most of these classes are defined using inheritance. We will provide an in-depth discussion of inheritance and related topics in Chapter 13.



1. If Class A inherits from Class B, which is a superclass? Which is a subclass?
2. Draw a diagram that shows Class A is inheriting from Class B.
3. What are the other names for superclass and subclass?
4. If we have Animal, Insect, and Mammal classes, which one will be a superclass?
5. Model different types of vehicles, using inheritance. Include Vehicle, Automobile, Motorcycle, Sports Car, Sedan, and Bicycle.

1.5 Software Engineering and Software Life Cycle

When we say *computer programming*, we are referring not only to writing Java commands, but also to a whole process of software development. Knowing a programming language alone is not enough to become a proficient software developer.

You must know how to design a program. This book will teach you how to design programs in an object-oriented manner.

We construct a house in well-defined stages and apply the engineering principles in all stages. Similarly, we build a program in stages and apply disciplined methodology in all stages of program development. The sequence of stages from conception to operation of a program is called the *software life cycle*, and *software engineering* is the application of a systematic and disciplined approach to the development, testing, and maintenance of a program.

There are five major phases in the software life cycle: analysis, design, coding, testing, and operation. Software starts its life from the needs of a customer. A person wants an online address book, for example. In the *analysis* phase, we perform a feasibility study. We analyze the problem and determine whether a solution is possible. Provided that a solution is possible, the result of this phase is a *requirements specification* that describes the features of a program. The features must be stated in a manner that is testable. One of the features for the address book program may be the capability to search for a person by giving his or her first name. We can test this feature by running the program and actually searching for a person. We verify that the program behaves as specified when the first name of a person in the address book and the first name of a person not in the address book are entered as a search condition. We do this testing in the testing phase, which we will explain shortly.

In the *design* phase, we turn a requirements specification into a detailed design of the program. For an object-oriented design, the output from this phase will be a set of classes that fulfill the requirements. For the address book program, we may design classes such as `Person`, `Phone`, and others.

In the *coding* phase, we implement the design into an actual program, in our case, a Java program. Once we have a well-constructed design, implementing it into actual code is really not that difficult. The difficult part is the creation of the design, and in this book, we place greater emphasis on the design aspect of the software construction.

When the implementation is completed, we move to the *testing* phase. In this phase, we run the program, using different sets of data to verify that the program runs according to the specification. Two types of testing are possible for object-oriented programs: *unit testing* and *integration testing*. With unit testing, we test classes individually. With integration testing, we test that the classes work together correctly. Activity to eliminate programming error is called *debugging*. An error could be a result of faulty implementation or design. When there's an error, we need to backtrack to earlier phases to eliminate the error.

Finally, after the testing is successfully concluded, we enter the *operation* phase, in which the program will be put into actual use. The most important and time-consuming activity during the operation phase is *software maintenance*. After the software is put into use, we almost always have to make changes to it. For example, the customer may request additional features, or previously undetected errors may be found. Software maintenance means making changes to software. It is estimated that close to 70 percent of the cost of software is related to software maintenance. So naturally, when we develop software, we should aim for software that is easy to maintain. We must not develop a piece of software hastily to reduce the software development cost. We should take time and care to design and code

software life cycle

software engineering

analysis

design

coding

testing

debugging

operation

software maintenance

software correctly even if it takes longer and costs more to develop initially. In the long run, carefully crafted software will have a lower total cost because of the reduced maintenance cost. Here's an important point to remember:

Things to Remember



Well-designed and -constructed software is easy to maintain.

In this book, we will focus on the design, coding, and testing phases. We will present a requirements specification in the form of a problem statement for the sample programs we will develop in this book. We present the first sample program developed by following the design, coding, and testing phases in Chapter 2. We will come back to the discussion of software engineering and the software life cycle throughout the book and provide more details.



1. Name the stages of the software life cycle.
2. How does the quality of design affect the software maintenance cost?
3. What is debugging?

Summary

- The style of programming we teach in this book is called object-oriented programming.
- An object is an instance of a class. Many instances can be created from a single class.
- There are class and instance methods. We can send messages to objects and classes if they possess matching methods.
- There are class and instance data values. Data values are also called data members.
- Inheritance is a powerful mechanism to model two or more entities that are different but share common features.
- The sequence of software development stages from conception to operation is called the software life cycle.
- Five major phases of the software life cycle are analysis, design, coding, testing, and operation.

- Software engineering is the application of a systematic and disciplined approach to the development, testing, and maintenance of a program.

Key Concepts

object-oriented programming	superclass (ancestor, base class)
class	subclass (descendant, derived class)
object	software life cycle
message	software engineering
class and instance methods	analysis
instance and class data values	design
variable	coding
constant	testing
inheritance	operation

Chapter 1 Exercises

Review Exercises

1. Graphically represent a Vehicle class and three Vehicle objects named car1, car2, and car3.
2. Graphically represent a Person class with the following components:
 - Instance variables name, age, and gender.
 - Instance methods setName, getName, and getAge.
 - Class method getAverageAge.
3. Design a CD class where a CD object represents a single music CD. What kinds of information (artist, genre, total playing time, etc.) do you want to know about a CD? Among the information in which you are interested, which are instance variables? Are there any class variables or class constants?
4. Suppose the Vehicle class in Exercise 1 is used in a program that keeps track of vehicle registration for the Department of Motor Vehicles. What kinds of instance variables would you define for such Vehicle objects? Can you think of any useful class variables for the Vehicle class?
5. Suppose the following formulas are used to compute the annual vehicle registration fee for the vehicle registration program of Exercise 4:
 - For cars, the annual fee is 2 percent of the value of the car.
 - For trucks, the annual fee is 5 percent of the loading capacity (in pounds) of the truck.

Define two new classes Car and Truck as subclasses of Vehicle. *Hint:* Associate class and instance variables common to both Car and Truck to Vehicle.

6. Consider a student registration program used by the registrar's office. The program keeps track of students who are registered for a given semester. For each student registered, the program maintains the student's name, address, and phone number; the number of classes in which the student is enrolled; and the student's total credit hours. The program also keeps track of the total number of registered students. Define instance and class variables of a Student class that is suitable for this program.
7. Suppose the minimum number and maximum number of courses for which a student can register are different depending on whether the student is a graduate, undergraduate, or work/study student. Redo Exercise 6 by defining classes for different types of students. Relate the classes, using inheritance.
8. Imagine you are given the task of designing an airline reservation system that keeps track of flights for a commuter airline. List the classes you think would be necessary for designing such a system. Describe the data values and methods you would associate with each class you identify. *Note:* For this exercise and Exercises 9 through 12, we are not expecting you to design the system in complete detail. The objective of these exercises is to give you a taste of thinking about a program at a very high level. Try to identify about a half dozen or so classes, and for each class, describe several methods and data members.
9. Repeat Exercise 8, designing a university course scheduling system. The system keeps track of classes offered in a given quarter, the number of sections offered, and the number of students enrolled in each section.
10. Repeat Exercise 8, designing the state Department of Motor Vehicles registration system. The system keeps track of all licensed vehicles and drivers. How would you design objects representing different types of vehicles (e.g., motorcycles and trucks) and drivers (e.g., class A for commercial licenses and class B for towing vehicles)?
11. Repeat Exercise 8, designing a sales tracking system for a fast-food restaurant. The system keeps track of all menu items offered by the restaurant and the number of daily sales per menu item.
12. When you write a term paper, you have to consult many references: books, journal articles, newspaper articles, and so forth. Repeat Exercise 8, designing a bibliography organizer that keeps track of all references you used in writing a term paper.
13. Consider the inheritance hierarchy given in Figure 1.12. List the features common to all classes and the features unique to individual classes. Propose a new inheritance hierarchy based on the types of accounts your bank offers.
14. Consider a program that maintains an address book. Design an inheritance hierarchy for the classes such as Person, ProfessionalContact, Friend, and Student that can be used in implementing such a program.
15. Do you think the design phase is more important than the coding phase? Why or why not?
16. How does the quality of design affect the total cost of developing and maintaining software?

Getting Started with Java

2

O b j e c t i v e s

After you have read and studied this chapter, you should be able to

- Identify the basic components of Java programs.
- Write simple Java programs.
- Describe the difference between object declaration and object creation.
- Describe the process of creating and running Java programs.
- Use the **Date**, **SimpleDateFormat**, **String**, and **Scanner** classes from the standard Java packages.
- Develop Java programs, using the incremental development approach.

Introduction



W

e will describe the basic structure of simple Java programs in this chapter. We will also describe the steps you follow to run Java programs. We expect you to actually run these sample programs to verify that your computer (either your own or the one at the school's computer center) is set up properly to run the sample programs presented in the book. It is important to verify this now. Otherwise, if you encounter a problem later, you won't be able to determine whether the problem is the result of a bad program or a bad setup. Please check Appendix A for information on how to run the textbook's sample programs.

We will develop a sample application program in Section 2.4 following the design, coding, and testing phases of the software life cycle. We stress here again that our objective in this book is to teach object-oriented programming and how to apply object-oriented thinking in program development. The Java language is merely a means to implement a design into an executable program. We chose Java for this book because Java is a much easier language than other object-oriented programming languages to use to translate a design into an actual code. Beginning students often get lost in the language details and forget the main objective of learning the development process, but the use of Java should minimize this problem.

Hints, & Tips, Pitfalls



Those of you who have some experience in programming, whether object-oriented or non-object-oriented, will probably find many similarities between Java and the programming languages you already know. This similarity may accelerate your learning process, but in many cases what seems to be similar at first may turn out to be quite different. So please do not jump to any conclusions about similarity prematurely.

2.1 The First Java Program

pixel

Our first Java application program displays a window on the screen, as shown in Figure 2.1. The size of the window is set to 300 pixels wide and 200 pixels high. A *pixel* is a shorthand for *picture element*, and it is the standard unit of measurement for the screen resolution. A common resolution for a 19-in screen, for example, is 1280 pixels wide and 1024 pixels high. The title of the window is set to My First Java Program. Although this program is very simple, it still illustrates the fundamental structure of an object-oriented program, which is as follows:

Things to Remember



An object-oriented program uses objects.



Figure 2.1 Result of running the **Ch2Sample1** program. The window size is 300 by 200 pixels and has the title **My First Java Program**.

It may sound too obvious, but let's begin our study of object-oriented programming with this obvious notion. Here's the program code:

```
/*
   Chapter 2 Sample Program: Displaying a Window
   File: Ch2Sample1.java
*/
import javax.swing.*;
class Ch2Sample1 {
    public static void main(String[] args) {
        JFrame    myWindow;
        myWindow = new JFrame();
        myWindow.setSize(300, 200);
        myWindow.setTitle("My First Java Program");
        myWindow.setVisible(true);
    }
}
```

Hints, & Tips, Pitfalls



Closing the frame window of the `Ch2Sample1` program does not terminate the program itself. Most common Java development tools provide a simple way, such as clicking a toolbar button, to terminate a running program. If you are using a Java development tool that does not let you stop a running program easily, then insert the statement

```
myWindow.setDefaultCloseOperation(JFrame.EXIT_ON_CLOSE);
```

after

```
myWindow.setVisible(true);
```

so the program terminates automatically when the frame window is closed. Please read Appendix A for more information.

This program declares one class called `Ch2Sample1`, and the class includes one method called `main`. From this `main` method, the `Ch2Sample1` class creates and uses a `JFrame` object named `myWindow` by sending the three messages `setSize`, `setTitle`, and `setVisible` to the object. The `JFrame` class is one of many classes that come with the Java system. An instance of this `JFrame` class is used to represent a single window on the computer screen. To differentiate the classes that programmers define, including ourselves, and the predefined classes that come with the Java system, we will call the first *programmer-defined classes* and the latter *Java standard classes*, or simply, *standard classes*. We also use the term *system classes* to refer to the standard classes.

Expressing this program visually results in the *program diagram* shown in Figure 2.2. In this diagram, we draw individual messages, but doing so would easily clutter a diagram when we have more than a handful of messages. Instead of drawing messages individually, we can draw one arrow to represent a *dependency relationship*. For this program, we say the `Ch2Sample1` class is *dependent* on the services provided by a `JFrame` object, because the `Ch2Sample1` class sends messages to the `MyWindow` object. We draw a dotted arrow from `Ch2Sample1` to `myWindow` to indicate the dependency relationship, as shown in Figure 2.3

programmer-defined classes

standard classes

program diagram

dependency relationship

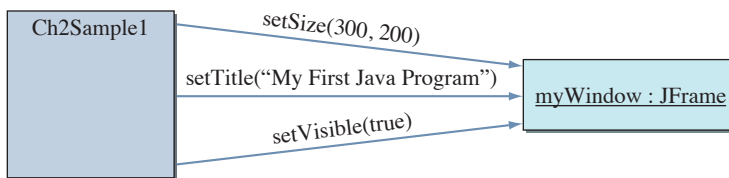

Figure 2.2 The program diagram for the `Ch2Sample1` program.

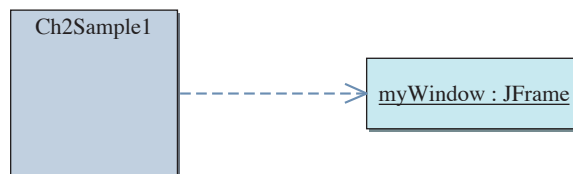

Figure 2.3 The program diagram for the `Ch2Sample1` program that shows the dependency relationship.

We begin the explanation of the program from the following core five lines of code:

```
JFrame    myWindow;

myWindow = new JFrame();

myWindow.setSize(300, 200);
myWindow.setTitle("My First Java Program");
myWindow.setVisible(true);
```

We will explain the rest of the program in Section 2.2. These five lines of code represent the crux of the program, namely, an object-oriented program that uses objects. The rule to remember in using objects is as follows:

Things to Remember



To use an object in a program, first we declare and create an object, and then we send messages to it.

In the remainder of this section, we will describe how to declare an object, create an object, and use an object by sending messages to the object.

Object Declaration

Every object we use in a program must be declared. An object declaration designates the name of an object and the class to which the object belongs. Its syntax is

```
<class name> <object names> ;
```

where <object names> is a sequence of object names separated by commas and <class name> is the name of a class to which these objects belong. Here's how the general syntax is matched to the object declaration of the program:

object
declaration
syntax

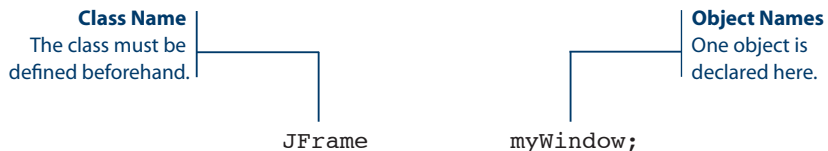

Here are more examples:

```
Account    checking;
Customer   john, jack, jill;
```

The first declaration declares an Account object named checking, and the second declaration declares three Customer objects.

To declare an object as an instance of some class, the class must be defined already. First we will study how to use objects from system classes. Later in the book, we will show you how to define your own classes, from which you can create instances.

identifier

When we declare an object, we must give it a name. Any valid identifier that is not reserved for other uses can be used as an object name. A Java *identifier* is a sequence of letters, digits, underscores (_), and dollar signs (\$) with the first one being a nondigit. We use an identifier to name a class, object, method, and others. The following words are all valid identifiers:

```
MyFirstApplication    _age
FunTime              Hello$World
ComputeArea          x123
DEFAULT_VALUE        velocity
```

Upper- and lowercase letters are distinguished, so the following four identifiers are distinct:

```
myWindow            mywindow
MYwindow            MYWINDOW
```

No spaces are allowed in an identifier, and therefore, the three lines

```
Sample Program
My First Application
Program FunTime
```

are all invalid identifiers.

Since upper- and lowercase letters are distinguished, you can use robot as the name for an object of the class Robot. We name objects in this manner whenever possible in this book so we can easily tell to which class the object belongs. We follow the Java *standard naming convention* of using an uppercase letter for the first letter of the class names and a lowercase letter for the first letter of the object names in this book. It is important to follow the standard naming convention so others who read your program can easily distinguish the purposes of identifiers. Programs that follow the standard naming convention are easier to read than those that do not. And remember that software maintenance is easier with easy-to-understand programs.

standard naming convention

When an identifier consists of multiple words, the Java naming convention dictates the first letter from every word will be capitalized, except the first word if the identifier is an object name. For example, we write **MyMainWindow** and **myMainWindow** for the class and object name, respectively.

Design Guidelines



Follow the standard naming convention in writing your Java programs to make them easier to read.

Table 2.2 in the Summary section summarizes the naming convention.

Object Creation

No objects are actually created by the declaration. An object declaration simply declares the name (identifier) that we use to refer to an object. For example, the declaration

```
JFrame    myWindow;
```

designates that the name `myWindow` is used to refer to a `JFrame` object, but the actual `JFrame` object is not yet created. We create an object by invoking the **new operator**. The syntax for `new` is

```
<object name> = new <class name> ( <arguments> ) ;
```

where `<object name>` is the name of a declared object, `<class name>` is the name of the class to which the object belongs, and `<arguments>` is a sequence of values passed to the `new` operation. Let's match the syntax to the actual statement in the sample program:

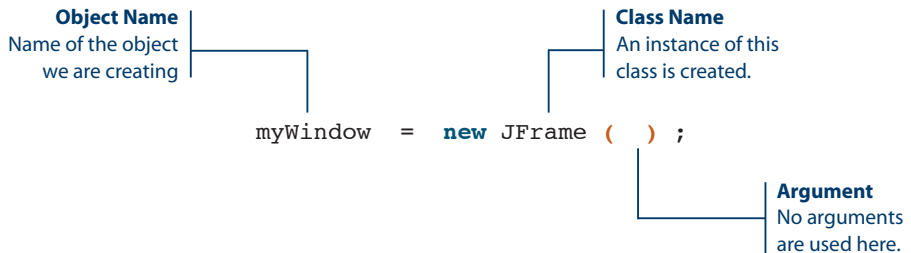

Figure 2.4 shows the distinction between object declaration and creation. Figure 2.5 shows the relationship between the UML-based program diagram and the state-of-memory diagram. The state-of-memory diagram borrows the notation from UML for consistency, but it is not a true UML diagram because it uses symbols and notations not found in UML.

Now, consider the following object declaration and two statements of object creation:

```
Customer customer;
customer = new Customer( );
customer = new Customer( );
```

What do you think will happen? An error? No. It is permissible to use the same name to refer to different objects of the same class at different times. Figure 2.6

Hints, & Tips, Pitfalls



Instead of writing statements for object declaration and creation separately, we can combine them into one statement. We can write, for example,

```
Student john = new Student();
```

instead of

```
Student john;
john = new Student();
```

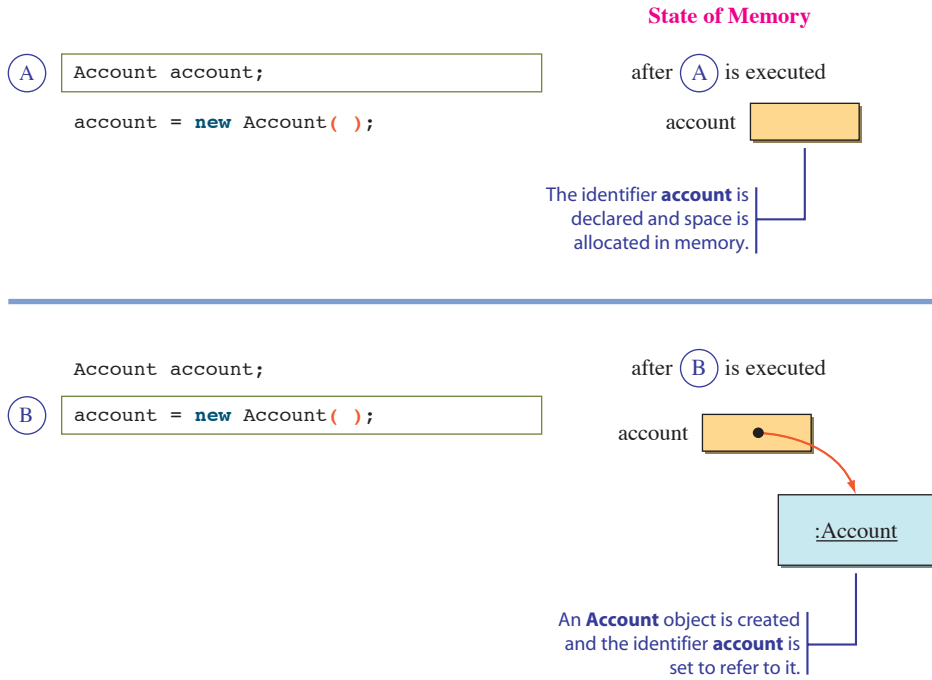



Figure 2.4 Distinction between object declaration and object creation.

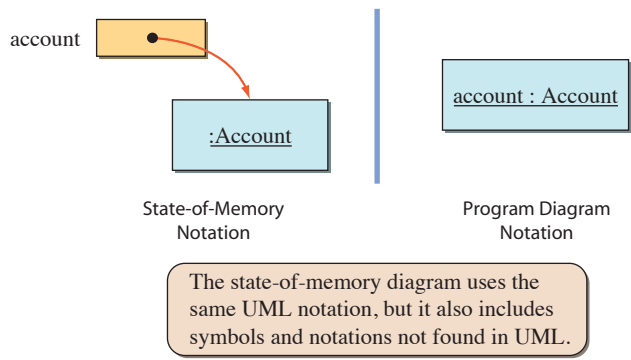

Figure 2.5 Relationship between the state-of-memory diagram and the program diagram notation.

shows the state-of-memory diagram after the second `new` is executed. Since there is no reference to the first `Customer` object anymore, eventually it will be erased and returned to the system. Remember that when an object is created, a certain amount of memory space is allocated for storing this object. If this allocated but unused space is not returned to the system for other uses, the space gets wasted. This

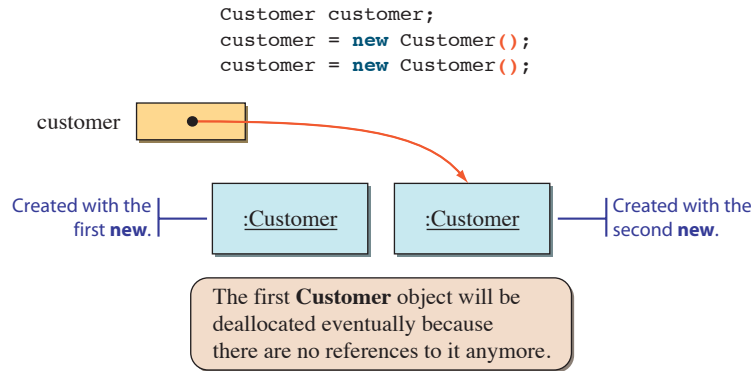

Figure 2.6 The state after two `new` commands are executed.

garbage
collection

returning of space to the system is called *deallocation*, and the mechanism to deallocate unused space is called *garbage collection*.

Message Sending

After the object is created, we can start sending messages to it. The syntax for sending a message to an object is

message-
sending syntax

```
<object name> . <method name> ( <arguments> ) ;
```

where `<object name>` is an object name, `<method name>` is the name of a method of the object, and `<arguments>` is a sequence of values passed to the method. In the sample program, we send the `setVisible` message with the argument `true` to the `mainWindow` object to make it appear on the screen. Once again, let's match the components in the general syntax to the actual statement:

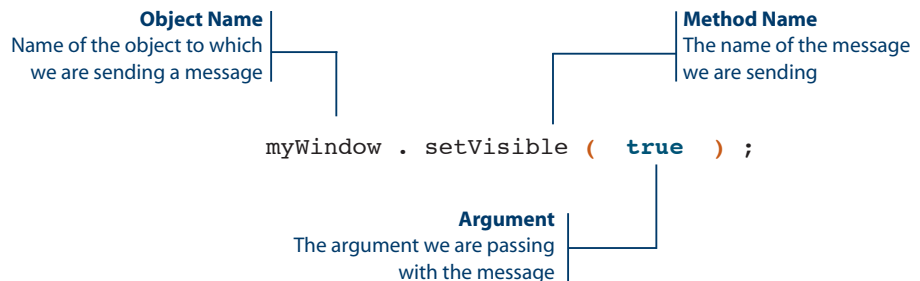

Figure 2.7 shows the correspondence between message sending as represented in the program diagram and in the Java statement. Because the object that receives a message must possess a corresponding method, we often substitute the expression *sending a message* with *calling a method*. We will use these expressions interchangeably.

Note: We can place method icons on either side of a class or instance icon.

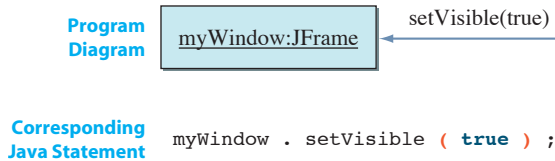

Figure 2.7 Correspondence between message sending as represented in the program diagram and in the actual Java statement.

Things to Remember



The expression calling object *O*'s method *M* is synonymous with sending message *M* to object *O*.

Notice the argument for the `setVisible` message does not include double quotes as did the one for the `setTitle` message in the example shown on page 32. The argument `true` is one of the two possible logical values (the other is `false`) used in Java programs. We will study more about the use of logical values later in the book, starting from Chapter 5. For now, it suffices to remember that there are two logical values—`true` and `false`—used for certain specific purposes.

Passing `true` in the `setVisible` message makes the receiving object appear on the screen. Passing `false` makes the object disappear from the screen. So, for example, if we write

```
myWindow.setVisible(true);
myWindow.setVisible(false);
myWindow.setVisible(true);
```

then `myWindow` will appear once, disappear, and then appear on the screen again. (*Note:* Because the computer will execute these statements so quickly, you may not notice any difference from the original program. See Exercise 25 on page 80.)

reserved word

The word `true` (and `false`) is called a *reserved word*. It is an identifier that is used for a specific purpose and cannot be used for any other purpose, such as for the name of an object.



1. Which of the following are invalid identifiers?
 - a. one
 - b. "Good Bye"
 - c. 1234
 - d. DecafeLattePlease

- e. \$hello\$
 - f. JAVA
 - g. hello, there
 - h. acct122
 - i. 4you
 - j. _doWork
 - k. Wait_For_Me
2. What's wrong with the following code?

```
JFrame myWindow();  
myWindow.setVisible(true);
```

3. Is there anything wrong with the following declarations?

```
mainWindow      MainWindow;  
Account, Customer  account, customer;
```

4. Which of the following statements is valid?

- a. myFirstWindow.setVisible("true");
- b. myFirstWindow.setVisible(true);

2.2 Program Components

Now that we have covered the crux of the first sample program, let's examine the rest of the program. The first sample application program Ch2Sample1 is composed of three parts: comment, import statement, and class declaration. These three parts are included universally in Java programs.

Things to Remember



A Java program is composed of comments, import statements, and class declarations.

You can write a Java program that includes only a single class declaration, but that is not the norm. In any nontrivial program, you will see these three components. We explain the three components and their subparts in this section.

Comments

comments

In addition to the instructions for computers to follow, programs contain *comments* in which we state the purpose of the program, explain the meaning of code, and provide

any other descriptions to help programmers understand the program. Here's the comment in the sample Ch2Sample1 program:

```

/*
  Chapter 2 Sample Program: Displaying a Window
  File: Ch2Sample1.java
*/
import javax.swing.*;

class Ch2Sample1 {
    public static void main(String[] args) {
        JFrame    myWindow;

        myWindow = new JFrame();

        myWindow.setSize(300, 200);
        myWindow.setTitle("My First Java Program");
        myWindow.setVisible(true);
    }
}

```

Comment

comment
markers

A comment is any sequence of text that begins with the marker `/*` and terminates with another marker `*/`. The beginning and ending *comment markers* are matched in pairs; that is, every beginning marker must have a matching ending marker. A beginning marker is matched with the next ending marker that appears. Any beginning markers that appear between the beginning marker and its matching ending marker are treated as part of the comment. In other words, you cannot put a comment inside another comment. The examples in Figure 2.8 illustrate how the matching is done.

single-line
comment
marker

Another marker for a comment is double slashes `//`. This marker is used for a *single-line comment marker*. Any text between the double-slash marker and the end of a line is a comment. The following example shows the difference between multiline and single-line comments:

```

/*
  This is a comment with
  three lines of
  text.
*/

// This is a comment
// This is another comment
// This is a third comment

```

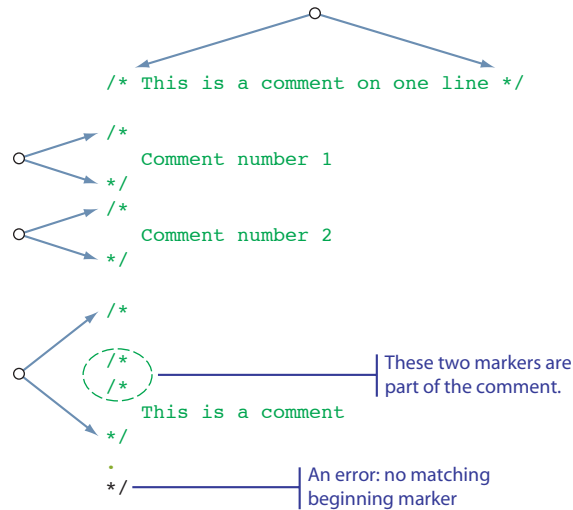

Figure 2.8 How the beginning and ending comment markers are matched.

Things to Remember



Although not required to run the program, comments are indispensable in writing easy-to-understand code.

javadoc comment

The third type of comment is called a *javadoc comment*. It is a specialized comment that can appear before the class declaration and other program elements yet to be described in the book. We will explain more about javadoc comments in Chapter 7.

Comments are intended for the programmers only and are ignored by the computer. Therefore, comments are really not necessary in making a program executable, but they are an important aspect of documenting the program. It is not enough to write a program that executes correctly. We need to document the program, and commenting the program is an important part of program documentation. Other parts of program documentation include program diagrams, programmers' work logs, design documents, and user manuals. If you can write a program once and use it forever without ever modifying it, then writing a program with no comments may be tolerable. However, in the real world, using programs without ever making any changes almost never happens. For example, you may decide to add new features and capabilities or modify the way the user interacts with the program. Even if you don't improve the program, you still have to modify the program when you detect some errors in it. Also, for commercial programs, those who change the programs are most often not the ones who developed them. When the time comes

for a programmer to modify his own or someone else's program, the programmer must first understand the program, and program documentation is an indispensable aid to understanding the program.

There are several different uses of comments. The first is the header comment. At the beginning of a program, we place a comment to describe the program. We characterize such a comment as a *header comment*. We also may include header comments at the beginning of methods to describe their purposes. Depending on the length and complexity of programs, the description may range from short and simple to long and very detailed. A typical header comment for a beginning programming class may look something like this:

header
comment

typical header
comment for a
beginning
programming
class

```

/*
 * Program:           TextEditor
 *
 * Author:            Decafe Latte
 *                   decafe@latte.com*
 *
 * Written:           May 1, 2008
 *
 * Course:            Comp Sci 101
 *                   Spring 2008
 *                   Program Assignment No. 7
 *
 * Compiler:          Java 6.0
 * Platform:          Windows Vista
 *
 * Description:
 *   This is a simple text editor. The editor allows the user
 *   to save text to a file and read text from a file. The
 *   editor displays text using Courier font only and does not
 *   allow formatting (e.g., bold, italic, etc.). The editor
 *   supports standard editing functions Cut, Copy, and
 *   Paste, but does not support Undo. For more details,
 *   please refer to the TxEditReadme file.
 */

```

Note: The use of the asterisks is in the style of javadoc, but this is not a javadoc comment.

For your own programs, you should write header comments following the guideline provided by your instructor. For listing the sample programs in the book, we will include only the program name and a short description in the header comment, mainly for reference purposes. The header comment in the actual programs, available from our website, includes additional information.

Another use of comments is to explain code whose purpose may not be obvious. Your aim is always to write easily understandable, self-explanatory program code. But at times this is not possible, and you should attach comment to code that is not so easy to understand. There also are times when the original code may not work as intended, and as a temporary measure, you modify the code slightly so the program will continue to work. You should clearly mark such modification with a comment, so you remember what you have done. If you did not put in an appropriate comment and later read your code without remembering about the modification, you would have no idea why you wrote such code. If you cannot understand your own code, imagine the frustration of other programmers (or your T.A. or instructor) trying to understand your modified code.

Yet another use of comments is to identify or summarize a block of code. Suppose a program is divided into three major parts: getting input values from the user, performing computation by using those values, and displaying the computation results. You can place comments at the top of each part to delineate the three major parts clearly.

Remember that adding comments to a poorly designed program will not make it a better program. Your foremost goal is to develop a well-designed program that runs efficiently and is easy to understand. Commenting a program is only a means toward that goal, not a goal itself. In fact, excessive use of comments makes it harder to follow and understand a program.

Design Guidelines



Always aim for self-explanatory code. Do not attempt to make poorly written code easier to read by comments. Good comments are not a substitute for good code. Bad code is bad, no matter how well your comments are written.

Hints, & Tips, Pitfalls



Comment markers are useful in disabling a portion of a program. Let's say you find a portion that may be causing the program to crash, and you want to try out different code for the problem portion. Instead of replacing the whole problem portion with new code, you can leave the questionable code in the program by converting it into a "comment" with comment markers. You can remove the comment markers if you need this code later.

Import Statement

We develop object-oriented programs by using predefined classes, both system- and programmer-defined, whenever possible and defining our own classes when no suitable predefined classes are available. In Java, classes are grouped into *packages*, and the Java system comes with numerous packages. We also can logically group our own classes into a package so they can be reused conveniently by other programs.

package

To use a class from a package, we refer to the class in our program by using the following format:

```
<package name> . <class name>
```

For example, to use the Resident class in the dorm package, we refer to it as

```
dorm.Resident
```

dot notation

which we read as “dorm dot Resident.” This notation is called *dot notation*.

A package can include subpackages, forming a hierarchy of packages. In referring to a class in a deeply nested package, we use multiple dots. For example, we write

```
javax.swing.JFrame
```

fully qualified name

to refer to the class JFrame in the javax.swing package; that is, the swing package is inside the javax package. Dot notation with the names of all packages to which a class belongs is called the class’s *fully qualified name*. Using the fully qualified name of a class is frequently too cumbersome, especially when we have to refer to the same class many times in a program. We can use the import statement to avoid this problem. Here’s the original Ch2Sample1 program that uses the import statement:

```
/*
   Chapter 2 Sample Program: Displaying a Window
   File: Ch2Sample1.java
*/
import javax.swing.*;
class Ch2Sample1 {
    public static void main(String[] args) {
        JFrame    myWindow;

        myWindow = new JFrame();

        myWindow.setSize(300, 200);
        myWindow.setTitle("My First Java Program");
        myWindow.setVisible(true);
    }
}
```

Import Statement

The **import** statement allows the program to refer to classes defined in the designated package without using the fully qualified class name.

And here's the same Ch2Sample1 program without the import statement:

```

/*
   Chapter 2 Sample Program: Displaying a Window
   File: Ch2Sample1.java
*/

class Ch2Sample1 {
    public static void main(String[] args) {
        javax.swing.JFrame myWindow;
        myWindow = new javax.swing.JFrame ();
        myWindow.setSize(300, 200);
        myWindow.setTitle("My First Java Program");
        myWindow.setVisible(true);
    }
}

```

No import statement

Fully qualified names

Instead of using the expression `javax.swing.JFrame` to refer to the class, we can refer to it simply as

```
JFrame
```

by including the import statement

```
import javax.swing.JFrame;
```

at the beginning of the program. Notice that the import statement is terminated by a semicolon. If we need to import more than one class from the same package, then instead of using an import statement for every class, we can import them all by using asterisk notation:

```
import <package name> . * ;
```

For example, if we state

```
import javax.swing.*;
```

then we are importing all classes from the `javax.swing` package. We use this asterisk notation in our sample program, even when we use only one of the many classes available in the `javax.swing` package. We could have used

```
import javax.swing.JFrame;
```

but it is more conventional to use asterisk notation. Notice that the package names are all in lowercase letters. This is another standard Java naming convention. Chapter 4 includes greater discussion of packages.

You
Might
Want to
Know



When we say “import a package,” it sounds as if we are copying all those classes into our programs. That is not the case. Importing a package is only a shorthand notation for referencing classes. The only effect of importing a package is the elimination of the requirement to use the fully qualified name. No classes are physically copied into our programs.

Class Declaration

A Java program is composed of one or more classes; some are predefined classes, while others are defined by us. In the first sample program, there are two classes—`JFrame` and `Ch2Sample1`. The `JFrame` class is one of the standard classes, and the `Ch2Sample1` class is the class we define ourselves. To define a new class, we must *declare* it in the program, or make a *class declaration*. The syntax for declaring the class is

class
declaration

```
class <class name> {
    <class member declarations>
}
```

where `<class name>` is the name of the class and `<class member declarations>` is a sequence of class member declarations. The word `class` is a reserved word used to mark the beginning of a class declaration. A class member is either a data value or a method. We can use any valid identifier that is not reserved to name the class. Here’s the class declaration in the sample `Ch2Sample1` program:

```
/*
   Chapter 2 Sample Program: Displaying a Window
   File: Ch2Sample1.java
*/
import javax.swing.*;
```

```

class Ch2Sample1 {
    public static void main(String[] args) {
        JFrame    myWindow;
        myWindow = new JFrame();
        myWindow.setSize(300, 200);
        myWindow.setTitle("My First Java Program");
        myWindow.setVisible(true);
    }
}

```

Class Declaration

Every program must include at least one class.

main class

One of the classes in a program must be designated as the *main class*. The main class of the sample program is Ch2Sample1. Exactly how you designate a class as the main class of the program depends on which Java program development tool you use. We will use the name of a main class to refer to a whole program. For example, we say the Ch2Sample1 *class* when we refer to the class itself, and we say the Ch2Sample1 *program* when we refer to the whole program.

If we designate a class as the main class, then we must define a method called main, because when a Java program is executed, the main method of a main class is executed first. To define a method, we must declare it in a class.

Method Declaration**method declaration**

The syntax for *method declaration* is

```

<modifiers> <return type> <method name> ( <parameters> ) {
    <method body>
}

```

where <modifiers> is a sequence of terms designating different kinds of methods, <return type> is the type of data value returned by a method, <method name> is the name of a method, <parameters> is a sequence of values passed to a method, and <method body> is a sequence of instructions. Here's the method declaration for the main method:

```

/*
Chapter 2 Sample Program: Displaying a Window
File: Ch2Sample1.java
*/

```

```
import javax.swing.*;
```

```
class Ch2Sample1 {
```

```
    public static void main(String[] args) {
        JFrame myWindow;
        myWindow = new JFrame();
        myWindow.setSize(300, 200);
        myWindow.setTitle("My First Java Program");
        myWindow.setVisible(true);
    }
}
```

Method Declaration
This declaration declares the **main** method.

Let's match these components to the actual method declaration of the sample program:

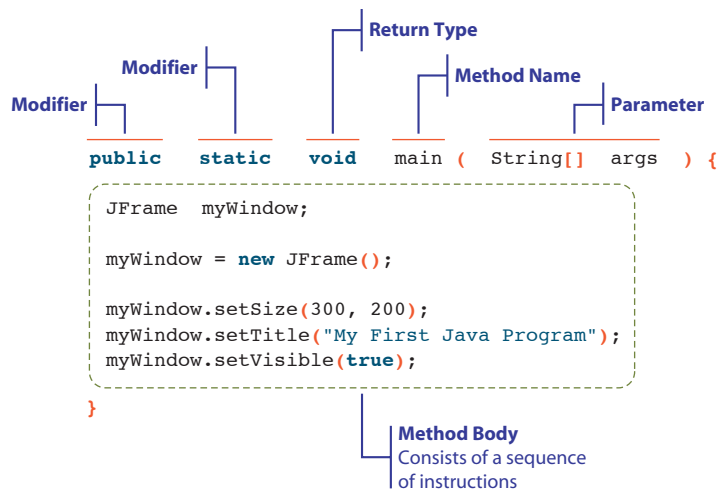

We do not explain the meanings of modifiers, return types, and parameters here. We will explain them in detail gradually as we progress through the book. For now, we ask you to follow a program template that we present next.

A Program Template for Simple Java Programs

The diagram in Figure 2.9 shows a program template for simple Java programs. You can follow this program template to write very simple Java programs. The structure of the sample program `Ch2Sample1` follows this template.

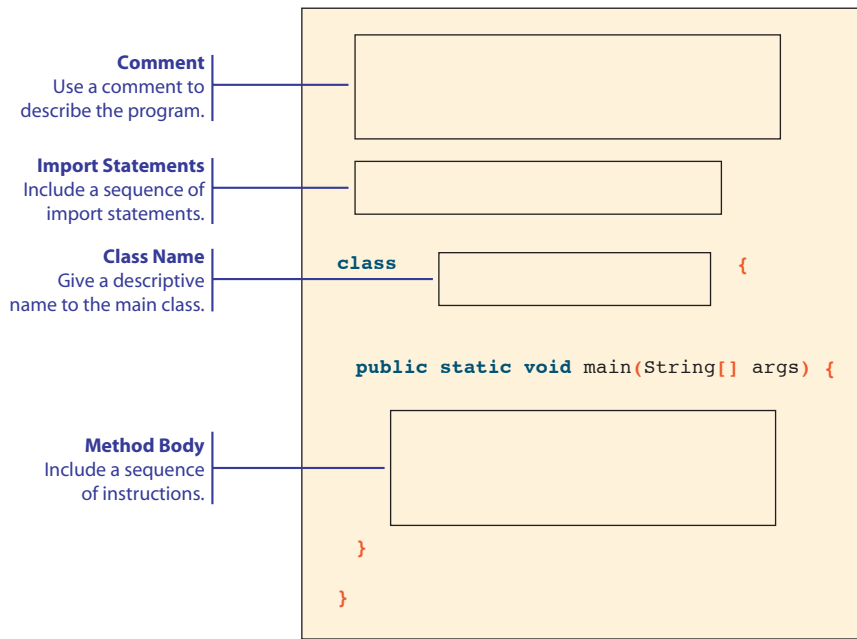

Figure 2.9 A program template for simple Java programs.

2.3 Edit-Compile-Run Cycle

edit-compile-
run cycle

We will walk through the steps involved in executing the first sample program. What we outline here are the overall steps in the *edit-compile-run cycle* common to any Java development tool you use. You need to get detailed instructions on how to use your chosen development tool to actually run programs. The steps we present in this section should serve as a guideline for more detailed instructions specific to your program development tool. Additional information on how to run Java programs can be found in Appendix A.

Step 1

source file

Type in the program, using an editor, and save the program to a file. Use the name of the main class and the suffix `.java` for the filename. This file, in which the program is in a human-readable form, is called a *source file*.

Ch2Sample1.java

```

/*
  Chapter 2 Sample Program: Displaying a Window
  File: Ch2Sample1.java
*/

```

```
import javax.swing.*;

class Ch2Sample1 {

    public static void main( String[] args ) {

        JFrame    myWindow;

        myWindow = new JFrame();

        myWindow.setSize(300, 200);
        myWindow.setTitle("My First Java Program");
        myWindow.setVisible(true);

    }
}
```

(source file)

Step 2

project file

bytecode

bytecode file

Compile the source file. Many compilers require you to create a *project file* and then place the source file in the project file in order to compile the source file. When the compilation is successful, the compiled version of the source file is created. This compiled version is called *bytecode*, and the file that contains bytecode is called a *bytecode file*. The name of the compiler-generated bytecode file will have the suffix *.class* while its prefix is the same as the one for the source file.

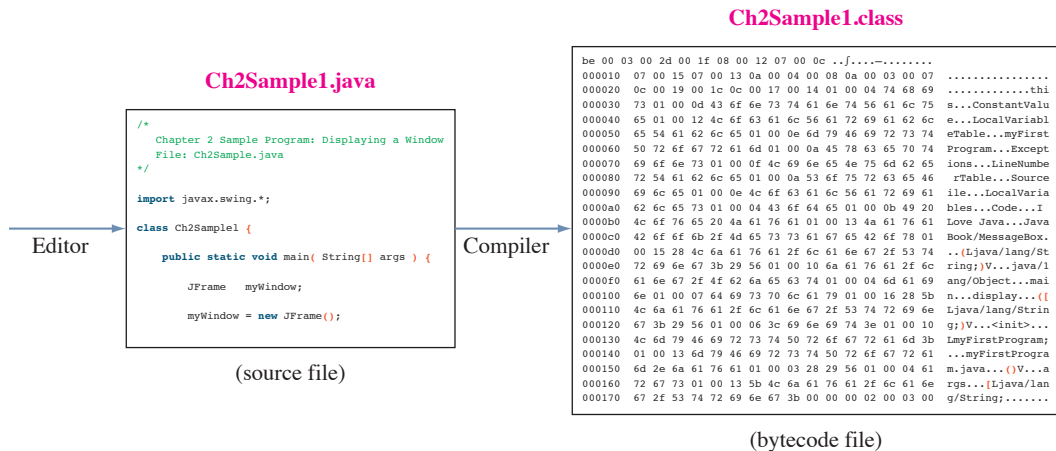

When any error occurs in a program, an error message will be displayed. If the sample program contains no errors in syntax, then instead of an error message, you

will get nothing or a message stating something like “Compiled successfully.” To see what kind of error messages are displayed, try compiling the following program. We purposely introduced three errors. Can you find them? Make sure to compile the correct Ch2Sample1 again before you proceed to the next step.

```
import javax.swing.*;

class Ch2Sample1 {

    public static void main( String[] args ) {
        myWindow = new JFrame();
        myWindow.setSize( );
        myWindow.setTitle("My First Java Program");
        myWindow.setVisible(true)
    }
}
```

compilation
error

Errors detected by the compiler are called *compilation errors*. Compilation errors are actually the easiest type of errors to correct. Most compilation errors are due to the violation of syntax rules.

Hints,
& Tips,
Pitfalls



It would be really nice if you get an error such as “Declaration for myWindow is missing” when you compile the bad version of the Ch2Sample1 program shown here. Unfortunately, you won’t receive such an informative and precise error message. When you actually compile the bad version, you will get a cryptic error message “cannot find symbol” four times (the number of times the object name myWindow appears in the program). The compiler can detect an error but it cannot generally pinpoint the cause of the error. As you gain more experience in programming, you will gradually become more adept in finding the cause of errors from these cryptic error messages.

You
Might
Want to
Know



When you use an advanced Java IDE tool such as Eclipse (www.eclipse.org) or NetBeans (www.netbeans.org), you do not have to perform the compilation step explicitly. Its high-power editor monitors your source code continually as you type and highlights any error.

Step 3

Execute the bytecode file. A Java interpreter will go through the bytecode file and execute the instructions in it. If your program is error-free, a window will appear on the screen.

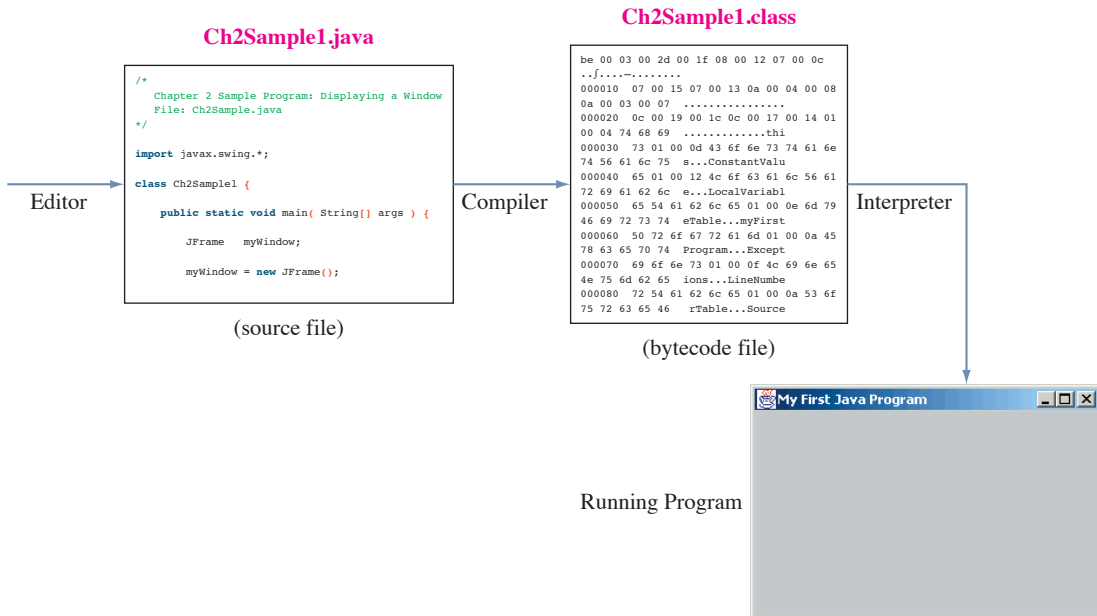
**execution error**

If an error occurs in running the program, the interpreter will catch it and stop its execution. Errors detected by the interpreter are called *execution errors*. If you did not see the expected results, go back to the previous steps and verify that your program is entered correctly. If you still do not see the expected results, then most likely your development environment is not set up correctly. Please refer to other sources of information for further help.

You Might Want to Know

Unlike machine-language instructions, or machine code, Java bytecode is not tied to any particular operating system or CPU. All we need to run the same Java programs on different operating systems is the Java interpreters for the desired operating systems. Currently, there are Java interpreters for Windows, Mac, Unix, and other operating systems. A Java interpreter is also called a Java Virtual Machine (JVM) because it is like a virtual machine that executes bytecode, whereas a CPU is a real machine that executes machine code.

2.4 | Sample Java Standard Classes

Eventually, you must learn how to define your own classes from which you create many instances. But before you do that, you must first master how to use existing classes. To this end, we will introduce seven standard classes here (in two of which

we only mention their names). We have two objectives in choosing these classes. First, we will reinforce and illustrate the core object-oriented programming concepts introduced in Chapter 1 with the actual Java statements that use these classes. Second, you will be able to start writing nontrivial Java programs using these classes. We do not want to overwhelm you, so we will cover only the basic operations of these classes, enough to get you started. We will discuss additional capabilities of these classes as we progress through the textbook.

Although we will scratch only the surface of these classes in this section, what we provide here should serve as a foundation for you to delve more deeply into these classes. For a more detailed description, please consult the documentation for the standard classes. The documentation for the standard classes is commonly called Java API documentation, where API stands for *application programming interface*.

Things to Remember



To become a good object-oriented programmer, first you must learn how to use predefined classes.

Hints, & Tips, Pitfalls



Please do not get alarmed by the number of standard classes we introduce here. Although we cover many standard classes at once, we limit ourselves to the most basic operations, so we won't overwhelm you with too much information. Their documentation can be located online at <http://java.sun.com/javase/6/docs/api>

2.4.1 Standard Output

When a program computes a result, we need a way to display this result to the user of the program. One of the most common ways to do this in Java is to use the *console window*. The console window is also called the *standard output window*. We output data such as the computation results or messages to the console window via `System.out`. The `System` class includes a number of useful class data values. One is an instance of the `PrintStream` class named `out`. Since this is a class data value, we refer to it through the class name as `System.out`, and this `PrintStream` object is tied to the console window (there's exactly one console window per program). Every data item we send to `System.out` will appear on this console window. We call the technique to output data by using `System.out` the *standard output*.

We use the `print` method to output a value. For example, executing the code

```
System.out.print("Hello, Dr. Caffeine.");
```

console
window

`System.out`

standard
output

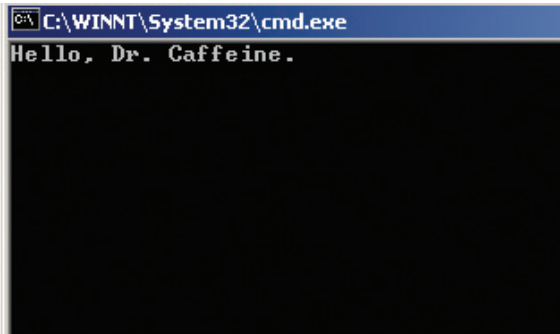
**Note**

Depending on the tool you use, you may see additional text such as **Press any key to continue...** or something similar to it. We will ignore any text that may be displayed automatically by the system.

Figure 2.10 Result of executing `System.out.print("Hello, Dr. Caffeine.")`.

will result in the console window shown in Figure 2.10. The actual appearance of the console window will differ depending on which Java development tool we use. Despite the difference in the actual appearance, its functionality of displaying data is the same among different Java tools.

Things to Remember



System.out refers to a **PrintStream** object we use to output data to the console window. The actual appearance of the console window depends on which Java tool we use.

The print method will continue printing from the end of the currently displayed output. Executing the following statements will result in the console window shown in Figure 2.11.

Code

```
System.out.print("How do you do? ");
System.out.print("My name is ");
System.out.print("Seattle Slew.");
```

Output

```
How do you do? My name is Seattle Slew.
```

Because the actual appearance of the console window is different depending on the Java development tool you use, we use a generic picture for the console window in the diagrams.

Figure 2.11 Result of executing three consecutive **print** methods. The **print** method continues the printing from the currently displayed output.

Code

```
System.out.println("How do you do? ");
System.out.println("My name is ");
System.out.println("Seattle Slew.");
```

Output

```
How do you do?
My name is
Seattle Slew.
```

Figure 2.12 Result of executing three consecutive `println` methods. The `println` method will skip to the next line after printing out its argument.

```
System.out.print("How do you do? ");
System.out.print("My name is ");
System.out.print("Seattle Slew.");
```

Notice that they all appear on the same line. If we want them to appear on individual lines, we can use the `println` method instead of `print`. The word *println* is a shorthand for “print line.” Figure 2.12 shows the effect of the `println` method.

This concludes our quick introduction to `System.out`. We will be gradually introducing additional techniques of outputting to the console window as they are needed.

Quick CHECK



1. Write a Java statement to display the text I Love Java in the console window.
2. Write statements to display the following shopping list in the console window. Don't forget to include blank spaces so the item names appear indented.

```
Shopping List:
    Apple
    Banana
    Low-fat Milk
```

2.4.2 String

The textual values we passed to the `print` method or the constructor of the `JFrame` class are instances of the `String` class. A sequence of characters separated by double quotes is `String` constants. As `String` is a class, we can create an instance and give it a name. For example,

```
String name;
name = new String("Jon Java");
```

will result in a situation as follows:

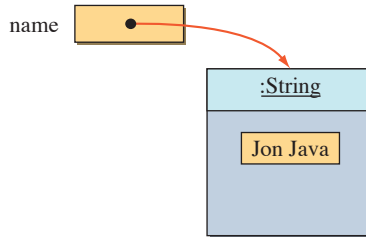

Unlike in other classes, the explicit use of `new` to create an instance is optional for the `String` class. We can create a new `String` object, for example, in this way:

```
String name;
name = "Decafe Latte";
```

substring

There are close to 50 methods defined in the `String` class. We will introduce three of them here: `substring`, `length`, and `indexOf`. We can extract a *substring* from a given string by specifying the beginning and ending positions. For example,

```
String text;
text = "Espresso";
System.out.print(text.substring(2, 7));
```

will display the dialog shown in Figure 2.13.

method composition

Notice the use of *method composition* in the last statement, where the result of a method call is used as an argument in another method call. In the statement

```
System.out.print (text.substring(2,7));
```

the result of method call

```
text.substring(2,7)
```

Code

```
String text;
text = "Espresso";
System.out.print(text.substring(2,7));
```

Output

```
press
```

Figure 2.13 Result of extracting and displaying the substring of "Espresso" from index position's 2 to 6. The index position of the first character in a string is 0.

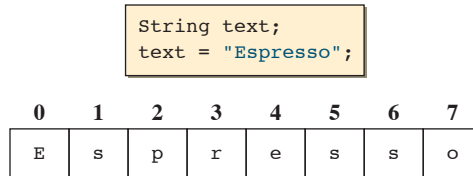

Figure 2.14 Individual characters in a string are numbered from 0.

is passed as an argument when calling the `showMessageDialog` method. The sample statement is equivalent to

```
String tempStr;

tempStr = text.substring(2,7);
System.out.print(tempStr);
```

Individual characters in a `String` object are indexed from 0, as illustrated in Figure 2.14. The first argument of the `substring` method specifies the position of the first character, and the second argument specifies the value that is 1 more than the position of the last character. Figure 2.15 shows how the `substring` method works. Here are some more examples:

```
text.substring( 6, 8 )  —————>  "so"
text.substring( 0, 8 )  —————>  "Espresso"
text.substring( 1, 5 )  —————>  "spre"
```

An error will result if you pass invalid arguments, such as negative values, the second argument larger than the number of characters in a string, or the first argument larger than the second argument.

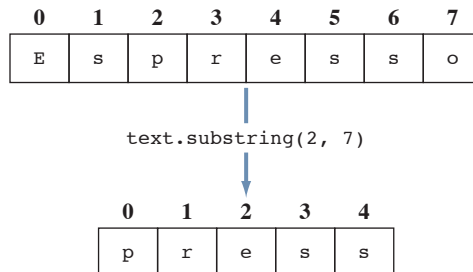

Figure 2.15 The effect of the `substring` method is shown. Notice that a new string is created, and the original string remains intact.

length

We can find out the number of characters in a `String` object by using the `length` method. For example, if the name `text` refers to a string `Espresso`, then

```
text.length()
```

will return the value `8`, because there are eight characters in the string. Here are some more examples:

```
text1 = "";           //empty string
text2 = "Hello";
text3 = "Java";

text1.length()  → 0
text2.length()  → 5
text3.length()  → 4
```

indexOf

To locate the index position of a substring within another string, we use the `indexOf` method. For example, if the name `text` refers to a string `I Love Java`, then

```
text.indexOf("Love")
```

will return the value `2`, the index position of the first character of the designated string `Love`. If the searched substring is not located in the string, then `-1` is returned. Notice that the search is done in a case-sensitive manner. Thus,

```
text.indexOf("java")
```

will return `-1`. If there is more than one occurrence of the same substring, the index position of the first character of the first matching substring is returned. Here are some more examples:

```

      3   7           21
      |   |           |
text = "I Love Java and Java loves me.";
text.indexOf("J")      → 7
text.indexOf("love")   → 21
text.indexOf("ove")    → 3
text.indexOf("ME")     → -1
```

string
concatenation

Beyond the three methods we cover here and the remaining methods of the String class, we have one very useful string operation in Java called *string concatenation*. We can create a new string from two strings by concatenating the two strings. We use the plus symbol (+) for string concatenation. Here are the examples:

```

        text1 = "Jon";
        text2 = "Java";

text1 + text2           →      "JonJava"
text1 + " " + text2    →      "Jon Java"
"How are you, " + text1 + "?"
                        →      "How are you, Jon?"

```

The sample class Ch2StringProcessing divides the given full name into the first and last names and displays the number of letters in the last name.

```

/*
   Chapter 2 Sample Program: Simple String Processing
   File: Ch2StringProcessing.java
*/
class Ch2StringProcessing {
    public static void main(String[] args) {
        String fullName, firstName, lastName, space;
        fullName = new String("Decafe Latte");
        space    = new String(" ");
        firstName = fullName.substring(0, fullName.indexOf(space));
        lastName  = fullName.substring(fullName.indexOf(space) + 1,
                                      fullName.length());

        System.out.println("Full Name: " + fullName);
        System.out.println("First: " + firstName);
        System.out.println("Last: " + lastName);
        System.out.println("Your last name has " + lastName.length( )
                           + " characters.");
    }
}

```



1. What will be the value of `mystery` when the following code is executed?

```
String text, mystery;

text    = "mocha chai latte";
mystery = text.substring(1,5);
```

2. What will be displayed on the message dialog when the following code is executed?

```
String text = "I, Claudius";

System.out.println(text.indexOf("I") );
```

3. What will be displayed on the message dialog when the following code is executed?

```
String text = "Augustus";

System.out.println(text.length());
```

4. What will be the value of `text3` when the following code is executed?

```
String text1 = "a" + "b";
String text2 = "c";

String text3 = text1 + text2 + text1;
```

2.4.3 Date and SimpleDateFormat

The `Date` class is used to represent a time instance to a millisecond (one-thousandth of a second) precision. This class is in the `java.util` package. When a new `Date` object is created, it is set to the time it is created (the current time is determined by reading the time maintained by the operating system on your machine). The `Date` class includes the `toString` method that converts its internal format to a string representation, which we can use to display the time. For example, executing the code

```
Date today;

today = new Date( );
System.out.println(today.toString());
```

will display the current time in this format:

```
Thu Dec 18 18:16:56 PST 2008
```

Notice that the current time, when converted to a string format, includes the date information also. Internally, the time is kept as an elapsed time in milliseconds since the standard base time known as the epoch, which is January 1, 1970, 00:00:00 GMT (Greenwich Mean Time).



Why is the class called **Date** when its purpose is to keep track of time? The reason is historical. In the older versions of Java, prior to JDK 1.1, the **Date** class was indeed used to manipulate the year, month, and day components of the current time. However, the way they are implemented was not amenable to internationalization. With the newer versions of Java, we use the **GregorianCalendar** class for date manipulation. The **GregorianCalendar** class is explained in Chapter 3.

If we do not like the default format, say we want to display only the month and year or only the hours and minutes in the AM/PM designation, then we can use the `SimpleDateFormat` class. This class is in the `java.text` package. For example, if we want to display the month, day, and year in the MM/dd/yy shorthand format, such as 07/04/08, we write

```
Date          today;
SimpleDateFormat sdf;

today = new Date( );
sdf   = new SimpleDateFormat("MM/dd/yy");

System.out.println(sdf.format(today));
```

If today is June 28, 2008, the code will display the date as

```
06/28/08
```

Notice the format designation is done by passing the formatting string when a new `SimpleDateFormat` object is created. The letters in the formatting string are case-sensitive. The formatting string in this example must be MM/dd/yy, and the letters d and y must be in lowercase. By increasing the number of formatting letters, we can change the length of the information, say, 2008 instead of 08. In case of the month, we change it from the number to a name. For example, when we change sdf to

```
sdf = new SimpleDateFormat("MMMM dd, yyyy");
```

the dialog will display

```
June 28, 2008
```

If we want to display which day of the week today is, we can use the letter E as in

```
Date          today;
SimpleDateFormat sdf;

today = new Date( );
sdf   = new SimpleDateFormat("EEEE");

System.out.println("Today is " + sdf.format(today));
```

Table 2.1 Some common formatting symbols for *SimpleDateFormat* and their meanings. Please check the Java API documentation for full details.

Symbol	Meaning	Value	Sample
y	Year	Number	yyyy → 2008
M	Month in year	Text or number	MM → 10 MMM → Oct MMMM → October
d	Day in month	Number	dd → 20
D	Day in year	Number	DDD → 289
h	Hour in AM/PM	Number	hh → 09
H	Hour in day (0–23)	Number	HH → 17
a	AM/PM marker	Text	a → AM
m	Minutes in hour	Number	mm → 35
s	Seconds in minute	Number	ss → 54
S	Millisecond	Number	mmm → 897
E	Day in week	Text	E → Sat EEEE → Saturday

Table 2.1 lists the common letters used in the formatting for *SimpleDateFormat*. For more details, please consult the Java API documentation.

Hints, & Tips, Pitfalls



Table 2.1 is provided solely for the purpose of quick reference when you start using the class in real programs. Nobody expects you to remember all those symbols. What is important here is for you to grasp the key OOP concepts and the fundamental way in which objects and classes are used, not to memorize minute details that nobody remembers.

If you do not pass any string when creating a new *SimpleDateFormat* object, the default formatting is used. The sample *Ch2DateDisplay* class displays today's date, using the default and programmer-designated format.

```

/*
Chapter 2 Sample Program: Displays Formatted Date Information
File: Ch2DateDisplay.java
*/

```

```

import java.util.*; //for Date
import java.text.*; //for SimpleDateFormat

class Ch2DateDisplay {

    public static void main(String[] args) {

        Date                today;

        SimpleDateFormat simpleDF1,
                           simpleDF2;

        today              = new Date();

        simpleDF1 = new SimpleDateFormat( );
        simpleDF2 = new SimpleDateFormat ("EEEE MMMM dd, yyyy");

        //Default short format display
        System.out.println("Today is " + simpleDF1.format(today) );

        //Programmer-designated long format display
        System.out.println("Today is " + simpleDF2.format(today) );

    }
}

```



1. Write a code fragment to display today's date in the 07-04-2008 format.
2. What will be displayed on the message dialog when the following code is executed if today is July 4, 1776?

```

Date                today;
SimpleDateFormat   sdf;

today = new Date( );
sdf   = new SimpleDateFormat("MMM dd, yyyy");

System.out.println("Today is " + sdf.format(today));

```

2.4.4 Standard Input

System.in
standard input
console input

Scanner

Analogous to System.out for output, we have **System.in** for input. We call the technique to input data using System.in *standard input*. System.in accepts input from the keyboard. We also use the term *console input* to refer to standard input. Using System.in for input is slightly more complicated than using System.out for output. System.in is an instance of the `InputStream` class that provides only a facility to input 1 byte at a time with its `read` method. However, multiple bytes are required to represent common types of data such as strings. The **Scanner** class from the `java.util`

package provides a necessary input facility to accommodate various input routines. We limit our discussion here to input of string values. We extend our discussion to input of numerical values in Chapter 3.

To input data from the standard input by using a `Scanner` object, we first create it by passing `System.in` as follows:

```
import java.util.*;
...
Scanner scanner;
scanner = new Scanner(System.in);
```

Once we have a `Scanner` object, then we can input a single word by using its `next` method. Here's code to input the first name of a person:

```
Scanner scanner = new Scanner(System.in);
String firstName;

//prompt the user for input
System.out.print("Enter your first name: ");
firstName = scanner.next( );
System.out.println("Nice to meet you, " + firstName + ".");
```

The user interaction of this sample code is shown in Figure 2.16. In the diagram, the characters entered by the user are displayed in the console window as they are typed in, so the user can see what's been entered. Printing out the values just entered is called *echo printing*. The string input is processed until the Enter (or Return) key is pressed, so we can erase the characters by pressing the Backspace key while entering the data.

echo printing

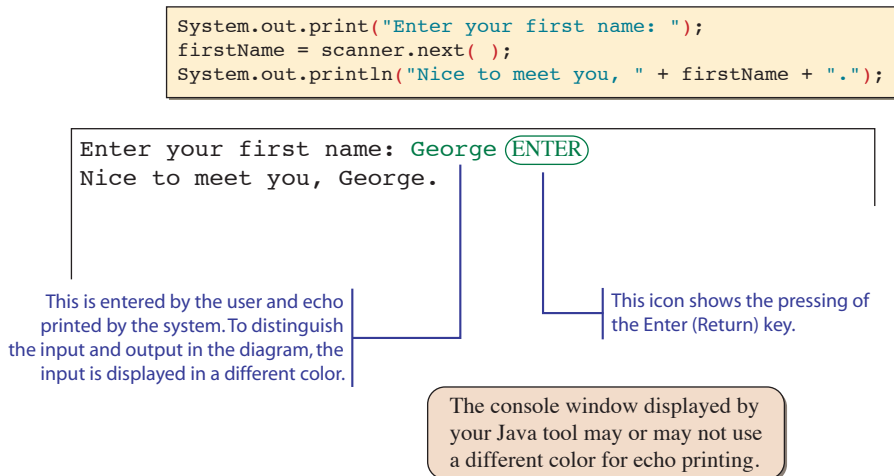

Figure 2.16 Sample interaction using `System.in` with `Scanner` and `System.out`. Keyboard input is echo-printed in the console window.

Now let's consider the case in which we want to input both the first name and the last name. We can follow the sample code and input them one by one as follows:

```
Scanner scanner = new Scanner(System.in);

String firstName, lastName;

System.out.print("Enter your first name: ");
firstName = scanner.next( );

System.out.print("Enter your last name: ");
lastName = scanner.next( );

System.out.println("Your name is " + firstName +
                  " " + lastName + ".");
```

```
Enter your first name: George 
Enter your last name: Washington 
Your name is George Washington.
```

What can we do if we want input both the first name and the last name together as a single input? Consider the following (wrong) code:

```
Scanner scanner = new Scanner(System.in);

String fullName;

System.out.print("Enter your first and last name: ");
fullName = scanner.next( );

System.out.println("Your name is " + fullName + ".");
```

Here's a sample interaction of a user entering both the first name and the last name on a single line:

```
Enter your first and last name: George Washington 
Your name is George.
```

What happened to the last name? The blank space between the first name and the last name is treated as a delimiter. So the system has accepted the characters up to, but not including, the blank space as the input value. Because we know there are first and last names, we can input them individually as follows:

```
Scanner scanner = new Scanner(System.in);

String first, last;

System.out.print("Enter your first and last name: ");
first = scanner.next( );
last = scanner.next( );
```

```
System.out.println("Your name is " + first + " "
                  + last + ".");
```

```
Enter your first and last name: George Washington ENTER
Your name is George Washington.
```

Instead of treating each word individually, it is possible to enter a set of words as a single input. To do so, we must reset the delimiter to other than the blank space. Any character can be set as a delimiter, but since we want to input the whole line as a single input, it is most reasonable to set the delimiter to the Enter key. Here's how we change the delimiter to the Enter key and accept the complete line as a single input:

```
Scanner scanner = new Scanner(System.in);

String lineSeparator
    = System.getProperty("line.separator");

scanner.useDelimiter(lineSeparator);

String quote;
System.out.println("Enter your favorite quote: ");
quote = scanner.next();

System.out.println("You entered: " + quote);
```

Note we're using `println` here.

```
Enter your favorite quote:
There never was a good war or a bad peace. ENTER
You entered: There never was a good war or a bad peace.
```

We override the default delimiter by calling the `useDelimiter` method and pass the appropriate argument. We use the class method `getProperty` of the `System` class to retrieve the actual sequence of characters for the Enter key that is specific to the platform which our program is running. For the Windows platform, for instance, we can call the `useDelimiter` method as

```
scanner.useDelimiter("\r\n");
```

But such code is guaranteed only to work on the Windows platform. It may or may not work on other platforms. To make the code general enough to work on all platforms, we use `System.getProperty`. Incidentally, the backslash character (`\`) is called a *control character* or an *escape character*. We'll examine the use of control characters later in the book.

Let's summarize what we have learned in this section by writing two sample programs. The first program will display a greeting after reading a person's name. The greeting will display only the person's first name even when the full name is entered. This means entering the input, say, John or John Smith, will result in the same display.

```
Hi, John. Nice to meet you.
```

To achieve this behavior, we will use the default delimiter for the string input so that only the characters up to the first space is entered. Here's the program:

```
/*
Chapter 2 Sample Program:
  Reads a person's name and displays a greeting.

File: Ch2Greetings.java
*/
import java.util.*;

class Ch2Greetings {

    public static void main(String[] args) {

        String firstName;

        Scanner scanner = new Scanner(System.in);

        System.out.print ("What is your name?");

        firstName = scanner.next( ); //accept characters up to, but not
                                    //including, the first space

        System.out.println("Hi, " + firstName + ". Nice to meet you.");

    }
}
```

The second program will accept the person's full name and display the name in reverse. Although it is a standard in Western countries to state our full name in the order of first and last names (e.g., Paul Revere), filing of our information, such as medical records, is almost always done in the order of last and first names (e.g., Revere, Paul). The program will display the following message:

```
Your medical record is filed under <last>, <first>.
```

where <last> and <first> are replaced by the actual first and last names entered by the user. For example, if the user enters Samuel Adams, the program will display

```
Your medical record is filed under Adams, Samuel.
```

Here we will again use the default delimiter for string input, and we accept the first and the last names separately as explained in this section.

```

/*
   Chapter 2 Sample Program: Input first and last names and display the
   name in the format of last name, first name

   File: Ch2RecordFiling.java
*/

import java.util.*;

class Ch2RecordFiling {

    public static void main(String[] args) {

        String firstName, lastName;

        Scanner scanner = new Scanner(System.in);

        System.out.print ("Your full name: ");

        firstName = scanner.next( );
        lastName = scanner.next( );

        System.out.println("Your medical record is filed under " +
            lastName + ", " + firstName + ".");

    }
}

```



1. Write a code to input the last name of a user.
2. Show the content of the console window when the following code is executed and the text Barbaro is entered:

```

Scanner scanner = new Scanner(System.in);

String winner;

System.out.print(
    "Enter the name of the derby winner: ");
winner = scanner.next( );

System.out.println("2006 Kentucky Derby Winner is "
    + name + ".");

```

2.5 Sample Development

Printing the Initials

Now that we have acquired a basic understanding of Java application programs, let's write a new application. We will go through the design, coding, and testing phases of the software life cycle to illustrate the development process. Since the program we develop here is very simple, we can write it without really going through the phases. However, it is extremely important for you to get into a habit of developing a program by following the software life cycle stages. Small programs can be developed in a haphazard manner, but not large programs. We will teach you the development process with small programs first, so you will be ready to use it to create large programs later.

We will develop this program by using an incremental development technique, which will develop the program in small incremental steps. We start out with a bare-bones program and gradually build up the program by adding more and more code to it. At each incremental step, we design, code, and test the program before moving on to the next step. This methodical development of a program allows us to focus our attention on a single task at each step, and this reduces the chance of introducing errors into the program.

Problem Statement

We start our development with a problem statement. The problem statement for our sample programs will be short, ranging from a sentence to a paragraph, but the problem statement for complex and advanced applications may contain many pages. Here's the problem statement for this sample development exercise:

Write an application that asks for the user's first, middle, and last names and replies with the user's initials.

Overall Plan

Our first task is to map out the overall plan for development. We will identify classes necessary for the program and the steps we will follow to implement the program. We begin with the outline of program logic. For a simple program such as this one, it is kind of obvious; but to practice the incremental development, let's put down the outline of program flow explicitly. We can express the program flow as having three tasks:

program
tasks

1. Get the user's first, middle, and last names.
2. Extract the initials to formulate the monogram.
3. Output the monogram.

Having identified the three major tasks of the program, we will now identify the classes we can use to implement the three tasks. First, we need an object to handle the input. At this point, we have learned about only the **Scanner** class, so we will use it here. Second, we need an object to display the result. Again, we will use **System.out**, as it is the only one we know at this point for displaying a string value. For the string

2.5 Sample Development—continued

manipulation, we will use the **String** class. Finally, we will use these classes from the main class, which we will call **Ch2Monogram**. Let's summarize these in a design document:

program
classes

Design Document: Monogram	
Class	Purpose
Ch2Monogram	The main class of the program.
Scanner	The next method is used for getting the full name.
String	The class is used for string manipulation, extracting initials from the first, middle, and last names.
(PrintStream) System.out	The standard output window is used for displaying the resulting monogram.

The program diagram of **Ch2Monogram** is shown in Figure 2.17. Keep in mind that this is only a preliminary design. Although we are not going to see any changes made to this design document because this sample application is very simple, changes to the design document are expected as the programs we develop become larger and more complex. The preliminary document is really a working document that we will modify and expand as we progress through the development steps.

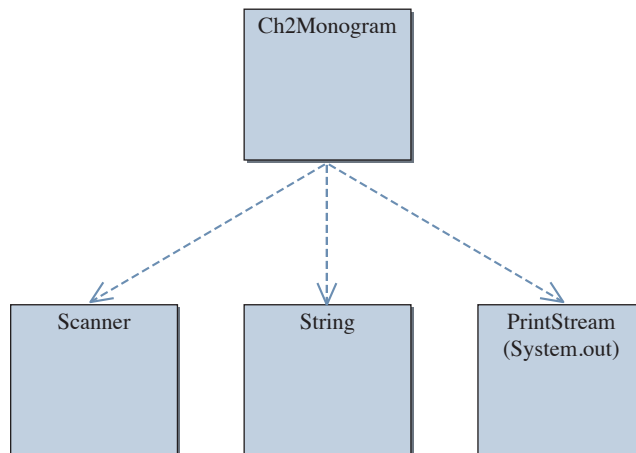

Figure 2.17 The program diagram for **Ch2Monogram**.

Before we can actually start our development, we must sketch the steps we will follow to develop the program. There is more than one possible sequence of steps to develop a program, and the number of possible sequences will increase as the program becomes more complex. For this program, we will develop the program in two steps:

development steps

1. Start with the program template and add code to get input.
2. Add code to compute and display the monogram.

Step 1 Development: Getting Input

step 1 design

The problem states that the program is to input the user's name and display its initials. It does not specify how, so in the design stage, we will decide how to do this. Since, at this point, we know only one way to input data, that is, using the **Scanner** class, we will use it here. But in which form shall we input three pieces of data? There are two possible design alternatives.

alternative design 1

In the first design, we will input them separately:

```
String firstName, middleName, lastName;

Scanner scanner = new Scanner(System.in);

System.out.print("First Name: ");
firstName = scanner.next( );

System.out.print("Middle Name: ");
middleName = scanner.next( );

System.out.print("Last Name: ");
lastName = scanner.next( );
```

alternative design 2

In the second design, we will input them together:

```
String fullName;

Scanner scanner = new Scanner(System.in);

scanner.useDelimiter(System.getProperty("line.separator"));

System.out.print("Full Name: ");
fullName = scanner.next( );
```

Which design is better? There is never "one correct answer" to the design problems. We have to select the one from the possible alternatives that satisfies the different criteria most effectively in a given situation. The criteria may include the user's needs and preferences, faster performance, development costs, time constraints, and other factors. For example, in one situation, we may decide to forgo some great user interface features so the development can be completed under budget.

In this sample development, we will consider the alternative designs from the overall quality of the program's user interface. In other words, we want to make our program as user-friendly as possible. We want our users to have a pleasant experience using our program. The program should not be cumbersome to use, or else the users will get

2.5 Sample Development—continued

very frustrated in using the program. Which design would give the better user experience? In the first approach, the user enters the information separately with three dialogs, while in the second approach, the user enters the information together with one dialog. We choose the second approach because it allows quicker data entry, and in general, it is more natural to treat the name as a single entity than as three separate entities. If we were to enter the name, address, and phone number, then we would use three dialogs as they are three separate entities. In this situation, we consider the first, middle, and last names as part of a single entity.

Notice that the decision to enter the full name by using one dialog makes our task as the programmer slightly more difficult because we need to extract the first, middle, and last names from a single string. In the first approach, as we get the first, middle, and last names separately, there's no such need. So, if we consider strictly the ease of development, the first approach is better. It is important to remember, however, that we are developing the program for the sake of the users, not for ourselves.

Things to Remember



We develop programs for the sake of users, not for ourselves. Ease of use has higher priority than ease of development.

step 1 code

Let's implement the second design alternative. In the code, notice the use of the output statement that prints the string entered by the user. This printing of the input is another form of echo printing (introduced in Section 2.4.4). By echo printing, we verify that the input value is indeed read in correctly.

```

/*
  Chapter 2 Sample Program: Displays the Monogram
  File: Step1/Ch2Monogram.java
*/
import java.util.*;

class Ch2Monogram {

    public static void main(String[] args) {

        String name;

        Scanner scanner = new Scanner(System.in);

```

```
scanner.useDelimiter(System.getProperty("line.separator"));
System.out.print("Enter your full name (first, middle, last):");
name = scanner.next( );
System.out.println("Name entered: " + name);
}
}
```

step 1 test

After the program is written, we test the program to verify that the program runs as intended. The step 1 program may seem so trivial and not so useful, but it does serve a very useful purpose. Successful execution of this program verifies that the program setup is okay, the necessary packages are imported, and the objects are declared correctly. Since this program is very simple, there's not much testing strategy we can employ other than simply running it. For subsequent sample programs, however, the testing strategy will be more involved. After the step 1 program is compiled and executed correctly, we move on to step 2.

step 2 design

Step 2 Development: Computing and Displaying the Monogram

The next task is to extract initials from the input string. First, because of our limited knowledge of programming at this point, we will assume the input is correct. That is, the input string contains first, middle, and last names, and they are separated by single blank spaces. Second, there are many possible solutions, but we will solve this problem by using only the methods covered in this chapter. Reviewing the string methods we covered in this chapter and the **Ch2String Processing** class, we know that a sequence of **indexOf** and **substring** methods can divide a string (full name) into two substrings (first and last names). How can we adapt this technique to now divide a string (full name) into three substrings (first, middle, and last names)? Aha! We apply the sequence one more time, as shown in Figure 2.18.

Once we divide the input name into first, middle, and last names, extracting the initials is a fairly straightforward application of the **indexOf** method. We can extract the first letter of a string as

```
str.substring(0, 1)
```

And the monogram can be formulated by concatenating three initials as

```
first.substring(0, 1)
+ middle.substring(0, 1)
+ last.substring(0, 1)
```

2.5 Sample Development—continued

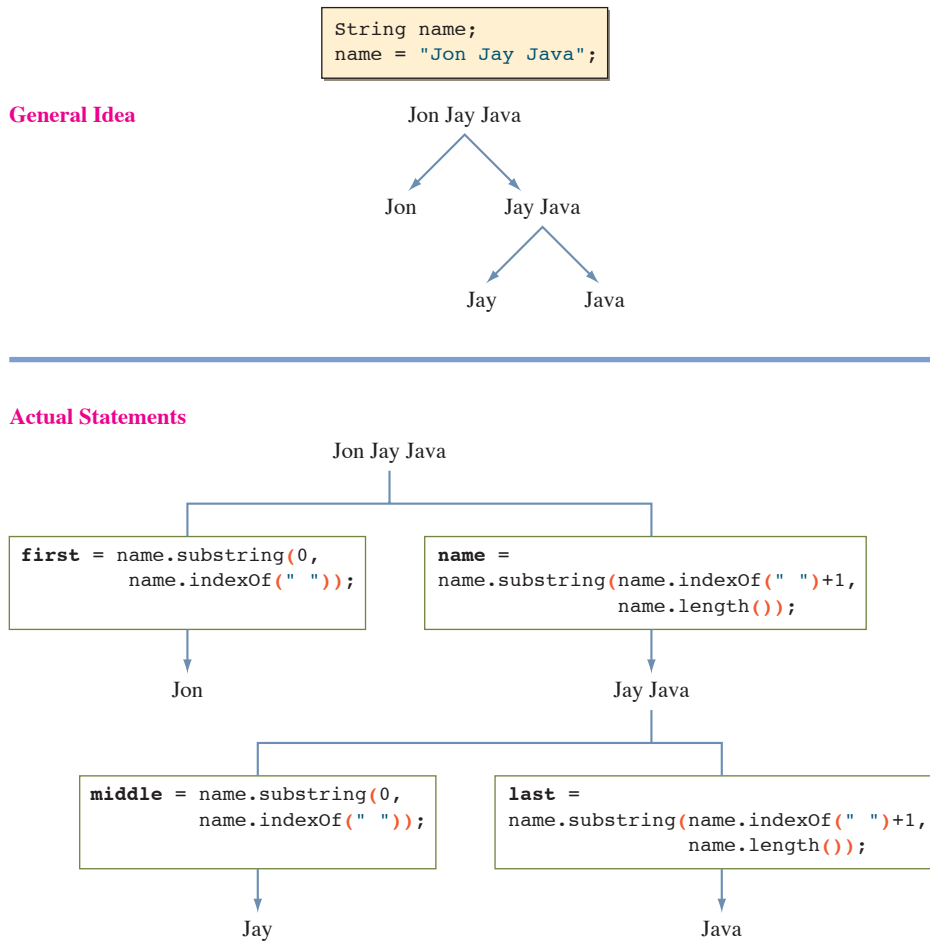

Figure 2.18 Apply the two sequences of **indexOf** and **substring** methods to extract three substrings from a given string.

step 2 code

Here's our step 2 code:

```

/*
Chapter 2 Sample Program: Displays the Monogram
File: Step2/Ch2Monogram.java
*/
  
```

```
import java.util.*;
class Ch2Monogram {
    public static void main(String[] args) {
        String name;
        Scanner scanner = new Scanner(System.in);
        scanner.useDelimiter(System.getProperty("line.separator"));
        System.out.print("Enter your full name (first, middle, last):");
        name = scanner.next( );
        System.out.println("Name entered: " + name);
    }
}
```

step 2 test

To verify the computation is working correctly, we run the program multiple times and enter different names. Remember that we are assuming there is no error in input; that is, first, middle, and last names are separated by single blank spaces. Since there are two sub-tasks involved in this step, it is important to test them separately. To verify that the input string is divided into three substrings correctly, we place the following temporary test output statements.

```
System.out.println("First:" + first);
System.out.println("Middle:" + middle);
System.out.println("Last:" + last);
```

These statements are not shown in the step 2 program listing, but they are included in the actual sample code.

Summary

- The three basic components of a Java program are comments, import statements, and class declarations.
- A Java program must have one class designated as the main class. The designated main class must have the main method.
- An object must be declared and created before we can use it.
- To command an object or a class to perform a task, we send a message to it. We use the expression *calling a method* synonymously with *sending a message*.
- A single name can be used to refer to different objects (of the same class) at different times. An object with no reference will be returned to a system.

- We follow the edit-compile-run cycle to execute programs.
- A source file is compiled into a bytecode file by a Java compiler.
- A Java interpreter (also called a Java Virtual Machine) executes the bytecode.
- The standard classes introduced (mentioned) in this chapter are

Date	Scanner
InputStream	SimpleDateFormat
JFrame	String
PrintStream	System

- Table 2.2 lists the Java naming convention.

Table 2.2 Standard naming convention for Java

Category	Convention	Example
Class	Use an uppercase letter for the first letter of the class names. If the name consists of multiple words, the first letter of every word is capitalized.	Customer MainWindow MyInputHandler
Instance	Use a lowercase letter for the first letter of the object names. If the name consists of multiple words, the first letter of every word (except the first word) is capitalized.	customer inputHandler myFirstApplication
Constant	(Note: Sample use of a constant will appear in Chap. 4. We include it here for completeness and easy reference later.) Use all uppercase letters. If the constant consists of multiple words, the underscore characters are used to separate the words.	DEFAULT_RATE DEG_TO_RAD CANCEL
Package	Use all lowercase letters.	java game finance

Key Concepts

standard classes	packages
program diagram	dot notation
identifier	class declaration
standard naming convention	method declaration
new operator	edit-compile-run cycle
garbage collection	source file
comments	bytecode file

Chapter 2 Exercises

Review Exercises

1. Identify all errors in the following program (color highlighting is disabled):

```
/*
    Program Exercise1
    Attempting to display a frame window
//
import swing.JFrame;
class Exercise 1 {
    public void Main() {
        JFrame frame;
        frame.setVisible(TRUE)
    }
}
```

2. Identify all errors in the following program (color highlighting is disabled):

```
//
    Program Exercise2
    Attempting to display a frame of size 300 by 200 pixels
//
import    Javax.Swing.*;
class two {
    public static void main method() {
        myFrame JFrame;
        myFrame = new JFrame();
        myFrame.setSize(300, 200);
        myFrame.setVisible();
    }
}
```

3. Identify all the errors in the following program (color highlighting is disabled):

```
/*
    Program Exercise3
    Attempting to display the number of characters
    in a given input.
*/
class three {
    public static void main( ) {
        String input;
        input = Scanner.next( );
    }
}
```

```

        System.out.print ("Input has " +
                          input.length() + " characters");
    }
}

```

4. Describe the purpose of comments. Name the types of comments available. Can you include comment markers inside a comment?
5. What is the purpose of the `import` statement? Does a Java program always have to include an `import` statement?
6. Show the syntax for importing one class and all classes in a package.
7. Describe the class that must be included in any Java application.
8. What is a reserved word? List all the Java reserved words mentioned in this chapter.
9. Which of the following are invalid Java identifiers?

a. R2D2	g. 3CPO
b. Whatchamacallit	h. This is okay.
c. HowAboutThis?	i. thisIsReallyOkay
d. Java	j. DEFAULT_AMT
e. GoodChoice	k. Bad-Choice
f. 12345	l. A12345
10. Describe the steps you take to run a Java application and the tools you use in each step. What are source files and bytecode files? What different types of errors are detected at each step?
11. Describe the difference between object declaration and object creation. Use a state-of-memory diagram to illustrate the difference.
12. Show a state-of-memory diagram after each of these statements is executed:

```

JFrame      window1;
Resident    res1, res2;

window1     = new JFrame();
res1        = new Resident( );
res2        = new Resident( );

```

13. Show a state-of-memory diagram after each of these statements is executed:

```

Person      person1, person2;

person1     = new Person();
person2     = new Person();
person2     = new Person();

```

14. Which of these identifiers violate the naming convention for class names?

a. r2D2	e. CPO
b. whatchamacallit	f. ThisIsReallyOkay
c. Java	g. java
d. GoodName	h. badName

15. Which of these identifiers violate the naming convention for object names?
- | | |
|----------------|---------------------|
| a. R2D2 | e. 3CPO |
| b. isthisokay? | f. ThisIsReallyOkay |
| c. Java | g. java |
| d. goodName | h. anotherbadone |
16. For each of these expressions, determine its result. Assume the value of text is a string Java Programming.

```
String text = "Java Programming";
```

- | |
|--|
| a. text.substring(0, 4) |
| b. text.length() |
| c. text.substring(8, 12) |
| d. text.substring(0, 1) + text.substring(7, 9) |
| e. text.substring(5,6)
+ text.substring(text.length()-3, text.length()) |

Level 1 Programming Exercises ★

17. Write a program that displays a frame window 800 pixels wide and 600 pixels high. Set the title of the frame to Welcome to Java.
18. Input the user's first and last name as two separate strings. Then display a frame window with its title set to <last>, <first>, where <last> and <first> are the input values. For example, if the input values are Johann and Strauss, then the title would be Strauss, Johann.
19. Input the user's first, middle, and last name as three separate strings and display the name in the order of the first name, the middle initial, and the last name. Include the period after the middle initial. If the input strings are Wolfgang, Amadeus, and Mozart, for example, then the output would be Wolfgang A. Mozart. Use the console window for output.
20. Write a program to display today's date in this format: 10 December 2008. Use the console window for output. Refer to Table 2.1 for the necessary designator symbols.
21. Repeat Exercise 20, but this time use this format: Monday December 10, 2008.

Level 2 Programming Exercises ★★

22. Write a program that displays a frame window W pixels wide and H pixels high. Use the Scanner to enter the values for W and H. The title of the frame is also entered by the user.
23. Display the current time in the title of a frame window using this format: 12:45:43 PM. Refer to Table 2.1 for the necessary designator symbols.

24. Write a Java program that displays a frame window 300 pixels wide and 200 pixels high with the title My First Frame. Place the frame so that its top left corner is at a position 50 pixels from the top of the screen and 100 pixels from the left of the screen. To position a window at a specified location, you use the `setLocation` method, as in

```
//assume mainWindow is declared and created
frame.setLocation( 50, 50 );
```

Through experimentation, determine how the two arguments in the `setLocation` method affect the positioning of the window.

25. Because today's computers are very fast, you will probably not notice any discernible difference on the screen between the code

```
JFrame myWindow;
myWindow = new JFrame( );
myWindow.setVisible( true );
```

and

```
JFrame myWindow;
myWindow = new JFrame( );
myWindow.setVisible( true );
myWindow.setVisible( false );
myWindow.setVisible( true );
```

One way to see the disappearance and reappearance of the window is to put a delay between the successive `setVisible` messages. Here's the magic code that puts a delay of 0.5 s:

```
try {Thread.sleep(500);} catch(Exception e) { }
```

The argument we pass to the `sleep` method specifies the amount of delay in milliseconds [*note*: 1000 milliseconds (ms) = 1 second (s)]. We will not explain this magic code.

26. Using the `Scanner`, input a string that contains a single exclamation mark. Divide the input string into two strings, one before and the other after the exclamation mark, and output them. Do not include the exclamation mark in the output. For example, if the input string is one potato two potato !three, then the output would be

```
one potato two potato
three
```

Level 3 Programming Exercises ★★★

27. Write a program that accepts a string input and outputs the number of characters in the string and the first and last character in separate lines. For

example, if the input is I like Java then the output would be

```
11
I
a
```

28. Write a program that accepts a word and prints out the middle character. The length of the input word is odd. For example, if the input is magnificent, which has 11 characters, you output the sixth character f. You use the division operator /. This operator returns only the quotient. For example, the expression $10/4$ would result in 2 (not 2.5).
29. At the McGraw-Hill book website, you will find a Java package called galapagos. The galapagos package includes a Turtle class that is modeled after Seymour Papert's logo. This Turtle has a pen, and when you move the Turtle, its pen will trace the movement. So by moving a Turtle object, you can draw many different kinds of geometric shapes. For example, this program commands a Turtle to draw a square:

```
import galapagos.*;
class Square {
    public static void main( String[] arg ) {
        Turtle turtle;
        turtle = new Turtle( );

        turtle.move( 50 ); //move 50 pixels
        turtle.turn( 90 ); //turn 90 deg counterclockwise

        turtle.move( 50 );
        turtle.turn( 90 );

        turtle.move( 50 );
        turtle.turn( 90 );

        turtle.move( 50 );
    }
}
```

Write a program to draw a triangle. Read the documentation and see if you can find a way to draw the square in a different color and line thickness.

30. Using the Turtle introduced in Exercise 29, draw a star.
31. Using the Turtle introduced in Exercise 29, draw a big letter J. You can draw a big J by drawing one horizontal line, one vertical line, and one semi-circle as follows:



32. Using the Turtle introduced in Exercise 29, draw three nested rectangles.

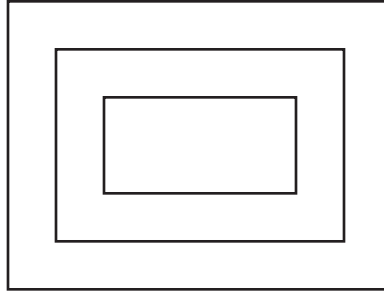

33. Using the Turtle introduced in Exercise 29, display the text Hello five times at the approximate positions shown below:

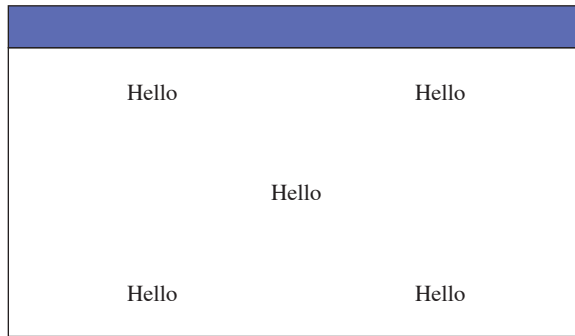

Development Exercises

34. Follow the incremental development methodology explained in this chapter to implement a program for the following problem statement. You must clearly write down the program tasks, create a design document with class descriptions, and draw the program diagram. Identify the development steps. State any assumptions you must make about the input. Articulate any design alternatives, and justify your selection. Be sure to perform adequate testing at the end of each development step.

Problem Statement: Write a program that asks the user for his or her birth date and replies with the day of the week on which he or she was born.

We learned in this chapter that we can create a `Date` object for today's date by writing

```
import java.util.*;
...
Date today = new Date();
```

To create a `Date` object for a date other than today, we can use the `Date` class from the `java.sql` package. (A more general and flexible way to deal with a

date by using the `GregorianCalendar` class is introduced in Chap. 3.) Notice that there are two distinct classes with the same name `Date`, but from different packages—one from `java.util` and another from `java.sql`. To distinguish the two, we will use the fully qualified names. To create a new `java.util.Date` object, we can call the class method `valueOf` of the `java.sql.Date` class with the string representation of a date. The string representation must be in the format `yyyy-MM-dd`. For example, to create a `java.util.Date` object for July 4, 1776, we write

```
java.util.Date bdate = java.sql.Date.valueOf("1776-07-04");
```

Notice that `valueOf` is a class method of the `Date` class in the `java.sql` package. Calling it with a correct argument will return a `java.util.Date` object for the specified date.

35. Repeat Exercise 34 for this problem statement:

Problem Statement: Write a program that asks the user for her or his full name in the format

first middle last

and replies with the name in the format

last , first middle-initial.

where the last name is followed by comma and the middle initial is followed by period.

For example, if the input is

Decafe Chai Latte

then the output is

Latte, Decafe C.

36. Repeat Exercise 34 for this problem statement:

Problem Statement: Using the Turtle from Exercise 29, write a program that draws a house.

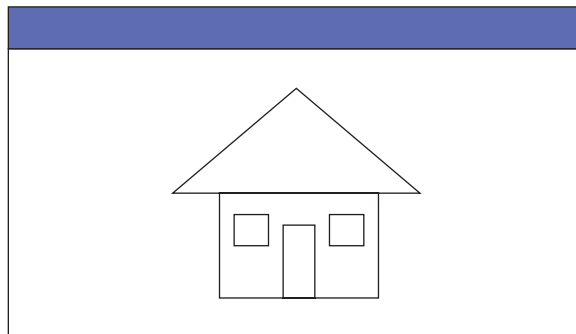

Numerical Data

3

O b j e c t i v e s

After you have read and studied this chapter, you should be able to

- Select proper types for numerical data.
- Write arithmetic expressions in Java.
- Evaluate arithmetic expressions, following the precedence rules.
- Describe how the memory allocation works for objects and primitive data values.
- Write mathematical expressions, using methods in the **Math** class.
- Use the **GregorianCalendar** class in manipulating date information such as year, month, and day.
- Use the **DecimalFormat** class to format numerical data.
- Convert input string values to numerical data.
- Input numerical data by using **System.in** and output numerical data by using **System.out**.
- Apply the incremental development technique in writing programs.
- (Optional) Describe how the integers and real numbers are represented in memory.

Introduction



W

hen we review the Ch2Monogram sample program, we can visualize three tasks: input, computation, and output. We view computer programs as getting input, performing computation on the input data, and outputting the results of the computations. The type of computation we performed in Chapter 2 is string processing. In this chapter, we will study another type of computation, the one that deals with numerical data. Consider, for example, a metric converter program that accepts measurements in U.S. units (input), converts the measurements (computation), and displays their metric equivalents (output). The three tasks are not limited to numerical or string values, though. An input could be a mouse movement. A drawing program may accept mouse dragging (input), remember the points of mouse positions (computation), and draw lines connecting the points (output). Selecting a menu item is yet another form of input. For beginners, however, it is easiest to start writing programs that accept numerical or string values as input and display the result of computation as output.

We will introduce more standard classes to reinforce the object-oriented style of programming. The `Math` class includes methods we can use to express mathematical formulas. The `DecimalFormat` class includes a method to format numerical data so we can display the data in a desired precision. The `GregorianCalendar` class includes methods to manipulate the date. The `Random` class includes methods to generate different types of random numbers. In Chapter 2, we performed String input and output by using the standard input (`Scanner`) and output (`System.out`). We will describe the input and output routines for numerical data in this chapter.

Finally, we will continue to employ the incremental development technique introduced in Chapter 2 in developing the sample application, a loan calculator program. As the sample program gets more complex, well-planned development steps will smooth the development effort.

3.1 Variables

Suppose we want to compute the sum and difference of two numbers. Let's call the two numbers x and y . In mathematics, we say

$$x + y$$

and

$$x - y$$

To compute the sum and the difference of x and y in a Java program, we must first declare what kind of data will be assigned to them. After we assign values to them, we can compute their sum and difference.

Let's say x and y are integers. To declare that the type of data assigned to them is an integer, we write

```
int    x, y;
```

variable

When this declaration is made, memory locations to store data values for `x` and `y` are allocated. These memory locations are called *variables*, and `x` and `y` are the names we associate with the memory locations. Any valid identifier can be used as a variable name. After the declaration is made, we can assign only integers to `x` and `y`. We cannot, for example, assign real numbers to them.

Things to Remember



A variable has three properties: a memory location to store the value, the type of data stored in the memory location, and the name used to refer to the memory location.

Although we must say “`x` and `y` are variable names” to be precise, we will use the abbreviated form “`x` and `y` are variables” or “`x` and `y` are integer variables” whenever appropriate.

The general syntax for declaring variables is

variable
declaration
syntax

```
<data type>    <variables> ;
```

where `<variables>` is a sequence of identifiers separated by commas. Every variable we use in a program must be declared. We may have as many declarations as we wish. For example, we can declare `x` and `y` separately as

```
int    x;
int    y;
```

However, we cannot declare the same variable more than once; therefore, the second declaration below is invalid because `y` is declared twice:

```
int    x, y, z;
int    y;
```

six numerical
data types

There are *six numerical data types* in Java: `byte`, `short`, `int`, `long`, `float`, and `double`. The data types `byte`, `short`, `int`, and `long` are for integers; and the data types `float` and `double` are for real numbers. The data type names `byte`, `short`, and others are all reserved words. The difference among these six numerical data types is in the range of values they can represent, as shown in Table 3.1.

higher
precision

A data type with a larger range of values is said to have a *higher precision*. For example, the data type `double` has a higher precision than the data type `float`. The tradeoff for higher precision is memory space—to store a number with higher precision, you need more space. A variable of type `short` requires 2 bytes and a variable of type `int` requires 4 bytes, for example. If your program does not use many integers, then whether you declare them as `short` or `int` is really not that critical. The difference in memory usage is very small and not a deciding factor in the program

Table 3.1 Java numerical data types and their precisions

Data Type	Content	Default Value [†]	Minimum Value	Maximum Value
byte	Integer	0	-128	127
short	Integer	0	-32768	32767
int	Integer	0	-2147483648	2147483647
long	Integer	0	-9223372036854775808	9223372036854775807
float	Real	0.0	-3.40282347E+38 [‡]	3.40282347E+38
double	Real	0.0	-1.79769313486231570E+308	1.79769313486231570E+308

[†] No default value is assigned to a local variable. A local variable is explained on page 191 in Section 4.8.

[‡] The character E indicates a number is expressed in scientific notation. This notation is explained on page 100.

design. The storage difference becomes significant only when your program uses thousands of integers. Therefore, we will almost always use the data type `int` for integers. We use `long` when we need to process very large integers that are outside the range of values `int` can represent. For real numbers, it is more common to use `double`. Although it requires more memory space than `float`, we prefer `double` because of its higher precision in representing real numbers. We will describe how the numbers are stored in memory in Section 3.10.

You Might Want to Know



Application programs we develop in this book are intended for computers with a large amount of memory (such as desktops or laptops), so the storage space is not normally a major concern because we have more than enough. However, when we develop applications for embedded or specialized devices with a very limited amount of memory, such as PDAs, cellular phones, mobile robots for Mars exploration, and others, reducing the memory usage becomes a major concern.

Here is an example of declaring variables of different data types:

```
int      i, j, k;
float    numberOne, numberTwo;
long    bigInteger;
double  bigNumber;
```

At the time a variable is declared, it also can be initialized. For example, we may initialize the integer variables `count` and `height` to 10 and 34 as in

```
int count = 10, height = 34;
```

Hints, & Tips, Pitfalls



As we mentioned in Chapter 2, you can declare and create an object just as you can initialize variables at the time you declare them. For example, the declaration

```
Date today = new Date();
```

is equivalent to

```
Date today;  
today = new Date();
```

assignment statement

We assign a value to a variable by using an *assignment statement*. To assign the value 234 to the variable named `firstNumber`, for example, we write

```
firstNumber = 234;
```

Be careful not to confuse mathematical equality and assignment. For example, the following are not valid Java code:

```
4 + 5 = x;  
x + y = y + x;
```

assignment statement syntax

The syntax for the assignment statement is

```
<variable> = <expression> ;
```

where `<expression>` is an arithmetic expression, and the value of `<expression>` is assigned to the `<variable>`. The following are sample assignment statements:

```
sum          = firstNumber + secondNumber;  
solution     = x * x - 2 * x + 1;  
average      = (x + y + z) / 3.0;
```

We will present a detailed discussion of arithmetic expressions in Section 3.2. One key point we need to remember about variables is the following:

Things to Remember



Before using a variable, we must first declare and assign a value to it.

The diagram in Figure 3.1 illustrates the effect of variable declaration and assignment. Notice the similarity with this and memory allocation for object declaration and creation, illustrated in Figure 2.4 on page 36. Figure 3.2 compares the two.

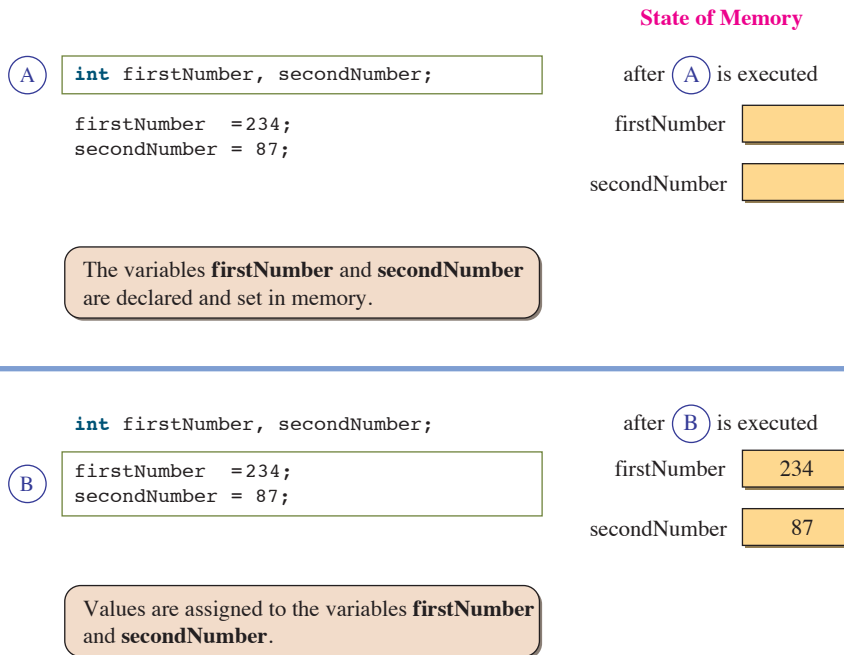

Figure 3.1 A diagram showing how two memory locations (variables) with names **firstNumber** and **secondNumber** are declared, and values are assigned to them.

What we have been calling object names are really variables. The only difference between a variable for numbers and a variable for objects is the contents in the memory locations. For numbers, a variable contains the numerical value itself; and for objects, a variable contains an address where the object is stored. We use an arrow in the diagram to indicate that the content is an address, not the value itself.

Things to Remember



Object names are synonymous with variables whose contents are references to objects (i.e., memory addresses).

Figure 3.3 contrasts the effect of assigning the content of one variable to another variable for numerical data values and for objects. Because the content of a variable for objects is an address, assigning the content of a variable to another makes two variables that refer to the same object. Assignment does not create a new object. Without executing the new command, no new object is created. We can view the situation in which two variables refer to the same object as the object having two distinct names.

Numerical Data

```
int number;
```

```
number = 237;
number = 35;
```

```
number
```



Object

```
Customer customer;
```

```
customer = new Customer();
customer = new Customer();
```

```
customer
```



```
int number;
```

```
number = 237;
```

```
number = 35;
```

```
number
```



```
Customer customer;
```

```
customer = new Customer();
```

```
customer = new Customer();
```

```
customer
```



```
int number;
```

```
number = 237;
```

```
number = 35;
```

```
number
```



```
Customer customer;
```

```
customer = new Customer();
```

```
customer = new Customer();
```

```
customer
```

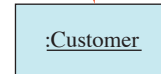
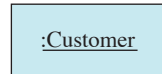

Figure 3.2 A difference between object declaration and numerical data declaration.

For numbers, the amount of memory space required is fixed. The values for data type `int` require 4 bytes, for example, and this won't change. However, with objects, the amount of memory space required is not constant. One instance of the `Account` class may require 120 bytes, while another instance of the same class may require 140 bytes. The difference in space usage for the account objects would occur if we had to keep track of checks written against the accounts. If one account has 15 checks written and the second account has 25 checks written, then we need more memory space for the second account than for the first account.

We use the `new` command to actually create an object. Remember that declaring an object only allocates the variable whose content will be an address. On the

Numerical Data

```
int number1, number2;
```

```
number1 = 237;
number2 = number1;
```

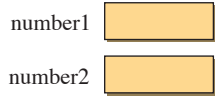

Object

```
Professor alan, turing;
```

```
alan = new Professor();
turing = alan;
```

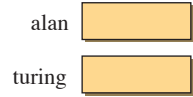

```
int number1, number2;
```

```
number1 = 237;
number2 = number1;
```

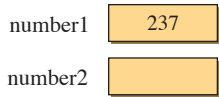

```
Professor alan, turing;
```

```
alan = new Professor();
turing = alan;
```

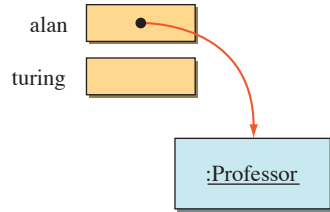

```
int number1, number2;
```

```
number1 = 237;
number2 = number1;
```

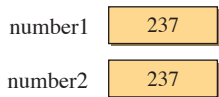

```
Professor alan, turing;
```

```
alan = new Professor();
turing = alan;
```

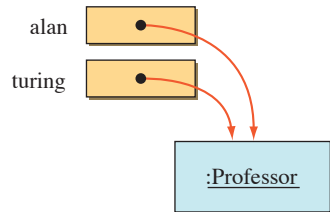

Figure 3.3 An effect of assigning the content of one variable to another.

reference
versus
primitive data
types

other hand, we don't "create" an integer because the space to store the value is already allocated at the time the integer variable is declared. Because the contents are addresses that refer to memory locations where the objects are actually stored, objects are called *reference data types*. In contrast, numerical data types are called *primitive data types*.

Hints, & Tips, Pitfalls



In addition to the six numerical data types, there are two nonnumerical primitive data types. The data type **boolean** is used to represent two logical values **true** and **false**. For example, the statements

```
boolean raining;
raining = true;
```

assign the value **true** to a boolean variable `raining`. We will explain and start using boolean variables beginning in Chapter 5. The second nonnumerical primitive data type is **char** (for character). It is used to represent a single character (letter, digit, punctuation marks, and others). The following example assigns the uppercase letter **A** to a **char** variable **letter**:

```
char letter;
letter = 'A';
```

A **char** constant is designated by single quotes. We will study the **char** data type in Chapter 9 on string processing.

Quick CHECK

1. Why are the following declarations all invalid (color highlighting is disabled)?

```
int      a, b, a;
float    x, int;
float    w, int x;
bigNumber double;
```

2. Assuming the following declarations are executed in sequence, why are the second and third declarations invalid?

```
int      a, b;
int      a;
float    b;
```

3. Name six data types for numerical values.
4. Which of the following are valid assignment statements (assuming the variables are properly declared)?

```
x        = 12;
12       = x;
y + y    = x;
y        = x + 12;
```

5. Draw the state-of-memory diagram for the following code.

```
Account latteAcct, espressoAcct;

latteAcct = new Account();
espressoAcct = new Account();
latteAcct = espressoAcct;
```

3.2 Arithmetic Expressions

An expression involving numerical values such as

$$23 + 45$$

arithmetic
operator

is called an *arithmetic expression*, because it consists of arithmetic operators and operands. An *arithmetic operator*, such as + in the example, designates numerical computation. Table 3.2 summarizes the arithmetic operators available in Java.

integer division

Notice how the division operator works in Java. When both numbers are integers, the result is an integer quotient. That is, any fractional part is truncated. Division between two integers is called *integer division*. When either or both numbers are float or double, the result is a real number. Here are some division examples:

Division Operation	Result
23 / 5	4
23 / 5.0	4.6
25.0 / 5.0	5.0

The modulo operator returns the remainder of a division. Although real numbers can be used with the modulo operator, the most common use of the modulo operator involves only integers. Here are some examples:

Modulo Operation	Result
23 % 5	3
23 % 25	23
16 % 2	0

Table 3.2 Arithmetic operators

Operation	Java Operator	Example	Value (x = 10, y = 7, z = 2.5)
Addition	+	x + y	17
Subtraction	−	x − y	3
Multiplication	*	x * y	70
Division	/	x / y	1
		x / z	4.0
Modulo division (remainder)	%	x % y	3

The expression $23 \% 5$ results in 3 because 23 divided by 5 is 4 with remainder 3. Notice that $x \% y = 0$ when y divides x perfectly; for example, $16 \% 2 = 0$. Also notice that $x \% y = x$ when y is larger than x ; for example, $23 \% 25 = 23$.

operand

An *operand* in arithmetic expressions can be a constant, a variable, a method call, or another arithmetic expression, possibly surrounded by parentheses. Let's look at examples. In the expression

$$x + 4$$

binary operator

we have one addition operator and two operands—a variable x and a constant 4. The addition operator is called a *binary operator* because it operates on two operands. All other arithmetic operators except the minus are also binary. The minus and plus operators can be both binary and unary. A unary operator operates on one operand as in

$$-x$$

In the expression

$$x + 3 * y$$

subexpression

the addition operator acts on operands x and $3 * y$. The right operand for the addition operator is itself an expression. Often a nested expression is called a *subexpression*. The subexpression $3 * y$ has operands 3 and y . The following diagram illustrates this relationship:

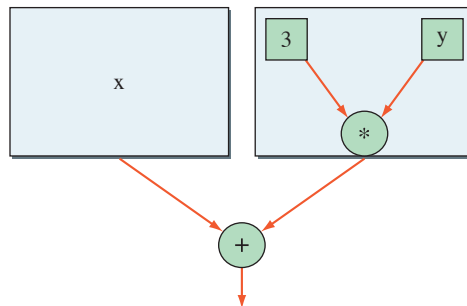

precedence rules

When two or more operators are present in an expression, we determine the order of evaluation by following the *precedence rules*. For example, multiplication has a higher precedence than addition. Therefore, in the expression $x + 3 * y$, the multiplication operation is evaluated first, and the addition operation is evaluated next. Table 3.3 summarizes the precedence rules for arithmetic operators.

Table 3.3 Precedence rules for arithmetic operators and parentheses

Order	Group	Operator	Rule
High  Low	Subexpression	()	Subexpressions are evaluated first. If parentheses are nested, the innermost subexpression is evaluated first. If two or more pairs of parentheses are on the same level, then they are evaluated from left to right.
	Unary operator	-, +	Unary minuses and pluses are evaluated second.
	Multiplicative operator	*, /, %	Multiplicative operators are evaluated third. If two or more multiplicative operators are in an expression, then they are evaluated from left to right.
	Additive operator	+, -	Additive operators are evaluated last. If two or more additive operators are in an expression, then they are evaluated from left to right.

The following example illustrates the precedence rules applied to a complex arithmetic expression:

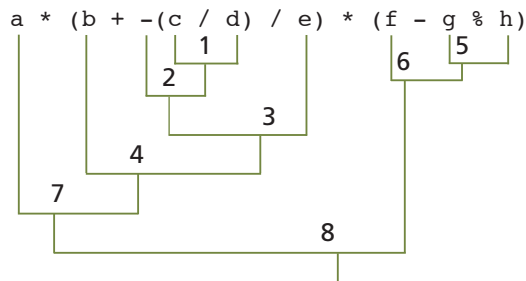

When an arithmetic expression consists of variables and constants of the same data type, then the result of the expression will be that data type also. For example, if the data type of *a* and *b* is *int*, then the result of the expression

$$a * b + 23$$

is also an *int*. When the data types of variables and constants in an arithmetic expression are different data types, then a casting conversion will take place. A *casting conversion*, or *typecasting*, is a process that converts a value of one data type to another data type. Two types of casting conversions in Java are *implicit* and *explicit*.

implicit and explicit type-casting

Table 3.4 Rules for arithmetic promotion

Operator Type	Promotion Rule
Unary	<ol style="list-style-type: none"> 1. If the operand is of type <code>byte</code> or <code>short</code>, then it is converted to <code>int</code>. 2. Otherwise, the operand remains the same type.
Binary	<ol style="list-style-type: none"> 1. If either operand is of type <code>double</code>, then the other operand is converted to <code>double</code>. 2. Otherwise, if either operand is of type <code>float</code>, then the other operand is converted to <code>float</code>. 3. Otherwise, if either operand is of type <code>long</code>, then the other operand is converted to <code>long</code>. 4. Otherwise, both operands are converted to <code>int</code>.

numeric promotion

An implicit conversion called *numeric promotion* is applied to the operands of an arithmetic operator. The promotion is based on the rules stated in Table 3.4. This conversion is called *promotion* because the operand is converted from a lower to a higher precision.

Instead of relying on implicit conversion, we can use explicit conversion to convert an operand from one data type to another. Explicit conversion is applied to an operand by using a *typecast operator*. For example, to convert the `int` variable `x` in the expression

typecast operator

```
x / 3
```

to `float` so the result will not be truncated, we apply the typecast operator (`float`) as

```
(float) x / 3
```

The syntax is

typecasting syntax

```
( <data type> ) <expression>
```

The typecast operator is a unary operator and has a precedence higher than that of any binary operator. You must use parentheses to typecast a subexpression; for example, the expression

```
a + (double) (x + y * z)
```

will result in the subexpression `x + y * z` typecast to `double`.

Assuming the variable `x` is an `int`, then the assignment statement

```
x = 2 * (14343 / 2344);
```

will assign the integer result of the expression to the variable `x`. However, if the data type of `x` is other than `int`, then an implicit conversion will occur so that the

assignment
conversion

data type of the expression becomes the same as the data type of the variable. An *assignment conversion* is another implicit conversion that occurs when the variable and the value of an expression in an assignment statement are not of the same data type. An assignment conversion occurs only if the data type of the variable has a higher precision than the data type of the expression's value. For example,

```
double number;
number = 25;
```

is valid, but

```
int number;
number = 234.56; ← INVALID
```

is not.

In writing programs, we often have to increment or decrement the value of a variable by a certain amount. For example, to increase the value of `sum` by 5, we write

```
sum = sum + 5;
```

shorthand
assignment
operator

We can rewrite this statement without repeating the same variable on the left- and right-hand sides of the assignment symbol by using the *shorthand assignment operator*:

```
sum += 5;
```

Table 3.5 lists five shorthand assignment operators available in Java.

These shorthand assignment operators have precedence lower than that of any other arithmetic operators; so, for example, the statement

```
sum *= a + b;
```

is equivalent to

```
sum = sum * (a + b);
```

Table 3.5 Shorthand assignment operators

Operator	Usage	Meaning
<code>+=</code>	<code>a += b;</code>	<code>a = a + b;</code>
<code>-=</code>	<code>a -= b;</code>	<code>a = a - b;</code>
<code>*=</code>	<code>a *= b;</code>	<code>a = a * b;</code>
<code>/=</code>	<code>a /= b;</code>	<code>a = a / b;</code>
<code>%=</code>	<code>a %= b;</code>	<code>a = a % b;</code>

Hints, & Tips, Pitfalls



If we wish to assign a value to multiple variables, we can cascade the assignment operations as

$$x = y = 1;$$

which is equivalent to saying

$$\begin{aligned} y &= 1; \\ x &= 1; \end{aligned}$$

The assignment symbol `=` is actually an operator, and its precedence order is lower than that of any other operators. Assignment operators are evaluated right to left.

Quick CHECK

- Evaluate the following expressions.
 - $3 + 5 / 7$
 - $3 * 3 + 3 \% 2$
 - $3 + 2 / 5 + -2 * 4$
 - $2 * (1 + -(3/4) / 2) * (2 - 6 \% 3)$
- What is the data type of the result of the following expressions?
 - $(3 + 5) / 7$
 - $(3 + 5) / (\text{float}) 7$
 - $(\text{float}) ((3 + 5) / 7)$
- Which of the following expressions is equivalent to $-b(c + 34)/(2a)$?
 - $-b * (c + 34) / 2 * a$
 - $-b * (c + 34) / (2 * a)$
 - $-b * c + 34 / (2 * a)$
- Rewrite the following statements without using the shorthand operators.
 - $x += y;$
 - $x *= v + w;$
 - $x /= y;$

3.3 Constants

While a program is running, different values may be assigned to a variable at different times (thus the name *variable*, since the values it contains can *vary*), but in some cases we do not want this to happen. In other words, we want to “lock” the assigned value so that no changes can take place. If we want a value to remain fixed, then we use a *constant*. A constant is declared in a manner similar to a variable but

constant

with the additional reserved word `final`. A constant must be assigned a value at the time of its declaration. Here's an example of declaring four constants:

```
final double PI = 3.14159;
final short FARADAY_CONSTANT = 23060; // unit is cal/volt
final double CM_PER_INCH = 2.54;
final int MONTHS_IN_YEAR = 12;
```

We follow the standard Java convention to name a constant, using only capital letters and underscores. Judicious use of constants makes programs more readable. You will be seeing many uses of constants later in the book, beginning with the sample program in this chapter.

named
constant

The constant `PI` is called a *named constant* or *symbolic constant*. We refer to symbolic constants with identifiers such as `PI` and `FARADAY_CONSTANT`. The second type of constant is called a *literal constant*, and we refer to it by using an actual value. For example, the following statements contain three literal constants:

literal constant

```
final double PI = 3.14159 ;
double area;
area = 2 * PI * 345.79 ;
```

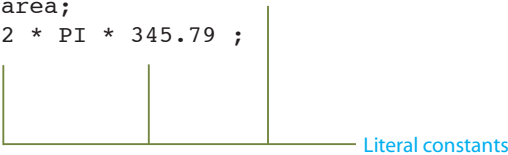

When we use the literal constant `2`, the data type of the constant is set to `int` by default. Then how can we specify a literal constant of type `long`?¹ We append the constant with an `l` (a lowercase letter `L`) or `L` as in

```
2L * PI * 345.79
```

How about the literal constant `345.79`? Since the literal constant contains a decimal point, its data type can be only `float` or `double`. But which one? The answer is `double`. If a literal constant contains a decimal point, then it is of type `double` by default. To designate a literal constant of type `float`, we must append the letter `f` or `F`. For example,

```
2 * PI * 345.79F
```

To represent a double literal constant, we may optionally append a `d` or `D`. So the following two constants are equivalent:

```
2 * PI * 345.79 is equivalent to 2 * PI * 345.79D
```

We also can express float and double literal constants in scientific notation as

Number $\times 10^{\text{exponent}}$

¹ In most cases, it is not significant to distinguish the two because of automatic type conversion; see Section 3.2.

exponential
notation in
Java

which in Java is expressed as

```
<number> E <exponent>
```

Hints, & Tips, Pitfalls



Since a numerical constant such as 345.79 represents a **double** value, these statements

```
float number;  
number = 345.79;
```

for example, would result in a compilation error. The data types do not match, and the variable (**float**) has lower precision than that of the constant (**double**). To correct this error, we have to write the assignment statement as

```
number = 345.79f;
```

or

```
number = (float) 345.79;
```

This is one of the common errors that people make in writing Java programs, especially those with prior programming experience.

where <number> is a literal constant that may or may not contain a decimal point and <exponent> is a signed or an unsigned integer. Lowercase e may be substituted for the exponent symbol E. The whole expression may be suffixed by f, F, d, or D. The <number> itself cannot be suffixed with symbols f, F, d, or D. Here are some examples:

```
12.40e+209  
23E33  
29.0098e-102  
234e+5D  
4.45e2
```

Here are some additional examples of constant declarations:

```
final double SPEED_OF_LIGHT = 3.0E+10D; // unit is cm/s  
final short MAX_WGT_ALLOWED = 400;
```

3.4 | Displaying Numerical Values

In Chapter 2, we learned how to output string values to the console window by using System.out. We can easily output numerical values to the console window

as well. We will use the same `print` and `println` methods to output numerical values. Here's a simple example that outputs the values of a constant and a variable:

```
int num = 15;

System.out.print(num); //print a variable
System.out.print(" "); //print a blank space
System.out.print(10); //print a constant
```

Executing the code will result in the following console window:

Console
Window

```
15 10
```

We can use the `println` method to skip a line after printing out the value. Executing

```
int num = 15;
System.out.println(num);
System.out.println(10);
```

will result in

Console
Window

```
15
10
```

By using the concatenation operation, it is possible to output multiple values with a single `print` or `println` method. For example, the statement

```
System.out.print(30 + " " + 40);
```

is equivalent to

```
System.out.print(30);
System.out.print(" ");
System.out.print(40);
```

Notice that the expression

```
30 + " " + 40
```

mixes numerical values and a string. We learned in Chapter 2 that the plus symbol is used to concatenate strings, for example,

```
"Benjamin" + " " + "Franklin"
```

And, in this chapter, we learned the same plus symbol is used to add numerical values, for example,

$$4 + 36$$

The plus symbol, therefore, could mean two different things: string concatenation or numerical addition. When a symbol is used to represent more than one operation, this is called *operator overloading*.

operator
overloading

What happens when the plus symbol appears in a mixed expression? When the Java compiler encounters an overloaded operator, the compiler determines the meaning of a symbol by its context. If the left operand and the right operand of the plus symbol are both numerical values, then the compiler will treat the symbol as addition; otherwise, it will treat the symbol as concatenation. The plus symbol operator is evaluated from left to right, and the result of concatenation is a string, so the code

```
int x = 1;
int y = 2;
String output = "test" + x + y;
```

will result in output being set to

```
test12
```

while the statement

```
String output = x + y + "test";
```

will result in output being set to

```
3test
```

To get the result of test3, we have to write the statement as

```
String output = "test" + (x + y);
```

so the arithmetic addition is performed first.

Now let's look at a small sample program that illustrates a typical use of string concatenation in displaying computation results. In this sample program, we compute the circumference and the area of a circle with a given radius. The value for the radius is assigned in the program (we will discuss how to input this value in Section 3.5). Here's the program:

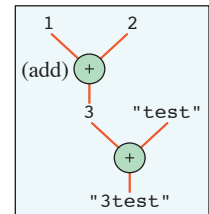
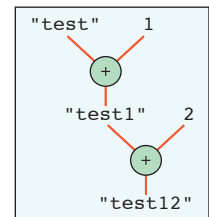

```
/*
```

```
Chapter 3 Sample Program: Compute Area and Circumference
```

```
File: Ch3Circle.java
```

```
*/
```

```

class Ch3Circle {
    public static void main(String[] args) {

        final double PI = 3.14159;

        double radius, area, circumference;

        radius = 2.35;

        //compute the area and circumference
        area          = PI * radius * radius;
        circumference = 2.0 * PI * radius;

        System.out.println("Given Radius: " + radius);
        System.out.println("Area: " + area);
        System.out.println("Circumference: " + circumference);
    }
}

```

When we run this program, we get the following output:

Console
Window

```

Given Radius: 2.35
Area: 17.349430775000002
Circumference: 14.765473

```

Notice the precision of decimal places displayed for the results, especially the one for the circumference. Although we desire such a high level of precision provided by double values during the computation, we may not when displaying the result. We can restrict the number of decimal places to display by using the `DecimalFormat` class from the `java.text` package.

Although the full use of the `DecimalFormat` class can be fairly complicated, it is very straightforward if all we want is to limit the number of decimal places to be displayed. To limit the decimal places to three, for example, we create a `DecimalFormat` object as

```
DecimalFormat df = new DecimalFormat("0.000");
```

and use it to format the number as

```
double num = 234.5698709;
System.out.println("Num: " + df.format(num));
```

When we add an instance of the `DecimalFormat` class named `df` and change the output statement of the `Ch3Circle` class to

```

System.out.println("Given Radius: " + df.format(radius));
System.out.println("Area: " + df.format(area));
System.out.println("Circumference: "
    + df.format(circumference));

```

we produce the following result:

Console
Window

```
Given Radius:  2.350
Area: 17.349
Circumference: 14.765
```

The modified class is named Ch3Circle2 (not shown here).

Instead of using one `println` method per line of output, it is possible to output multiple lines with a single `println` or `print` method by embedding a new-line control character in the output. We briefly mentioned a control character in Section 2.4.4. A control character is for controlling the output, and we use the backslash symbol to denote a control character. The new-line control character is denoted as `\n` and has the effect of pressing the Enter key in the output. For example, the statements

new-line
control
character

```
System.out.println("Given Radius: " + radius);
System.out.println("Area: " + area);
System.out.println("Circumference: " + circumference);
```

can be written by using only one `println` statement as

```
System.out.println("Given Radius: " + radius + "\n" +
                  "Area: " + area + "\n" +
                  "Circumference: " + circumference);
```

There is no limit to the number of new-line control characters you can embed, so we can easily skip two lines, for example, by putting two new-line control characters as follows:

```
System.out.println("Number 1: " + num1 + "\n\n" +
                  "Number 2: " + num2);
```

tab
control
character

Another useful control character is a *tab*, which is denoted as `\t`. We can use the tab *control character* to output the labels, and this results in two columns as follows:

```
System.out.println("Given Radius: " + "\t" + radius + "\n" +
                  "Area: " + "\t\t" + area + "\n" +
                  "Circumference: " + "\t" + circumference);
```

Notice there are two tabs before we output the area. You need to experiment with the actual number of tabs to get the right output (the actual number of spaces used for each tab could be different depending on your Java IDE). The resulting output will be

Console
Window

```
Given Radius:  2.35
Area:          17.349430775000002
Circumference: 14.765473
```

You can also adjust the output format by appending blank spaces in the label. For example, you can rewrite the sample statement as

```
System.out.println("Given Radius: " + "\t" + radius + "\n" +
                  "Area:           " + "\t" + area + "\n" +
                  "Circumference: " + "\t" + circumference);
```

And, as always, the use of symbolic constants will clean up the code:

```
...
final String TAB = "\t";
final String NEWLINE = "\n";
...
System.out.println(
    "Given Radius: " + TAB + radius + NEWLINE +
    "Area:         " + TAB + area   + NEWLINE +
    "Circumference: " + TAB + circumference);
```

The new program that illustrates the use of both `DecimalFormat` and control characters is named `Ch3Circle3`. Here's the program:

```
/*
   Chapter 3 Sample Program: Compute Area and Circumference
   File: Ch3Circle3.java
*/
import java.text.*;

class Ch3Circle3 {
    public static void main(String[] args) {
        final double PI = 3.14159;
        final String TAB = "\t";
        final String NEWLINE = "\n";

        double radius, area, circumference;

        DecimalFormat df = new DecimalFormat("0.000");
        radius = 2.35;

        //compute the area and circumference
        area      = PI * radius * radius;
        circumference = 2.0 * PI * radius;
        //Display the results
        System.out.println(
            "Given Radius: " + TAB + df.format(radius) + NEWLINE +
```

```

"Area:          " + TAB + df.format(area)  + NEWLINE +
"Circumference: " + TAB + df.format(circumference));
    }
}

```



1. What is the purpose of the control characters?
2. Which control character is used for a new line?
3. Using one print statement, output the following:

```

Hello, world!
My favorite Ben Franklin quote:

    An investment in knowledge
    always pays the best interest.

```

3.5 Getting Numerical Input

We learned how to input string values by using the `Scanner` class in Chapter 2. We study how to input numerical values with the `Scanner` class in this section. To input strings, we use the `next` method of the `Scanner` class. For the numerical input values, we use an equivalent method that corresponds to the data type of the value we try to input. For instance, to input an `int` value, we use the `nextInt` method. Here's an example of inputting a person's age:

```

Scanner scanner = new Scanner(System.in);
int age;
System.out.print("Enter your age: ");
age = scanner.nextInt( );

```

In addition to the `int` data type, we have five input methods that correspond to the other numerical data types. The six input methods for the primitive numerical data types are listed in Table 3.6.

Table 3.6 Methods to input six numerical data types

Method	Example
<code>nextByte()</code>	<code>byte b = scanner.nextByte();</code>
<code>nextDouble()</code>	<code>double d = scanner.nextDouble();</code>
<code>nextFloat()</code>	<code>float f = scanner.nextFloat();</code>
<code>nextInt()</code>	<code>int i = scanner.nextInt();</code>
<code>nextLong()</code>	<code>long l = scanner.nextLong();</code>
<code>nextShort()</code>	<code>short s = scanner.nextShort();</code>

The following example inputs a person's height in inches (int) and GPA (float):

```
Scanner scanner = new Scanner(System.in);
int height;
float gpa;
System.out.print("Enter your height in inches: ");
height = scanner.nextInt( );
System.out.print("Enter your gpa: ");
gpa = scanner.nextFloat( );
```

Remember that the default delimiter between the input values is a white space (such as the blank space or a tab); it is possible to input more than one value on a single line. The following code inputs two integers:

```
Scanner scanner = new Scanner(System.in);
int num1, num2;
System.out.print("Enter two integers: ");
num1 = scanner.nextInt( );
num2 = scanner.nextInt( );
System.out.print("num1 = " + num1 + " num2 = " + num2);
```

And here's a sample interaction:

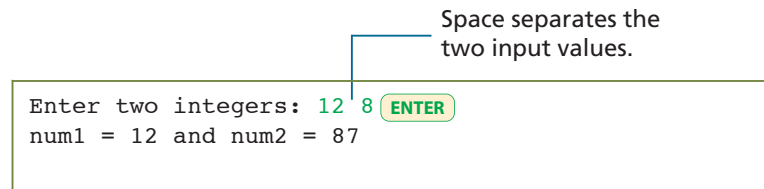

```
Enter two integers: 12 8 ENTER
num1 = 12 and num2 = 87
```

Since the new-line character (when we press the Enter key, this new-line character is entered into the system) is also a white space, we can enter the two integers by pressing the Enter key after each number. Here's a sample:

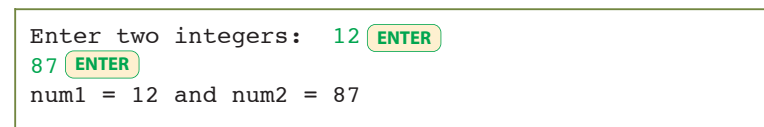

```
Enter two integers: 12 ENTER
87 ENTER
num1 = 12 and num2 = 87
```

input buffer

When we enter data using `System.in`, they are placed in *input buffer*. And the next available data in the input buffer are processed when one of the input methods is called. This means that the actual processing of input data does not necessarily correspond to the display timing of the prompts. Let's look at an example. Consider the following code:

```
Scanner scanner = new Scanner(System.in);
int num1, num2, num3;
```

```

System.out.print("Enter Number 1: ");
num1 = scanner.nextInt( );

System.out.print("Enter Number 2: ");
num2 = scanner.nextInt( );

System.out.print("Enter Number 3: ");
num3 = scanner.nextInt( );

System.out.print("Values entered are " +
                num1 + " " + num2 + " " + num3);

```

We expect the majority of users will input three integers, one at a time, as requested by the prompts:

```

Enter Number 1: 10 
Enter Number 2: 20 
Enter Number 3: 30 
Values entered are 10 20 30

```

However, users do not really have to enter the values one at a time. It is possible to enter all three values on a single line without waiting for prompts, for example. This will result in an awkward display in the console window. Here's an example:

```

Enter Number 1: 10, 20, 30 
Enter Number 2: Enter Number 3: Values entered are 10 20 30

```

Although the display is awkward, the input values are assigned to the respective variables correctly. The three input values are placed in the input buffer, and when the second and third `nextInt` methods are called, the corresponding values are already in the input buffer, so they get assigned to the variables correctly.

In Section 3.2, we explained the assignment conversion that allows us to assign a value to a higher-precision variable (e.g., assigning an `int` value to a `double` variable). This type of implicit conversion also occurs with the `Scanner` class. For example, the `nextDouble` method works without a problem as long as the user enters a value that is assignable to a `double` variable. Here's an example:

```

Scanner scanner = new Scanner(System.in);

double num;

System.out.print("Enter a double: ");
num = scanner.nextDouble( );

System.out.print("You entered " + num);

```

```

Enter a double: 35 
You entered 35.0

```

The `nextDouble` method accepts the value 35 and then converts it to a double data type. This method returns a double value, so even if the user enters an integer, you cannot assign the input to an `int` variable. The following code is therefore invalid:

```
Scanner scanner = new Scanner(System.in);
int num;
System.out.print("Enter an integer: ");
num = scanner.nextDouble( ); _____ Type mismatch
System.out.print("You entered " + num);
```

Now let's study how we can mix the input of strings and numerical values. We begin with an example. Consider inputting a racehorse's name and age. Here are a proposed code and a sample of expected interaction:

```
Scanner scanner = new Scanner(System.in);
String horseName;
int age;
System.out.print("Enter the horse name: ");
horseName = scanner.next( );
System.out.print("Enter the age: ");
age = scanner.nextInt( );
System.out.print(horseName + " is " + age + "years old." );
```

```
Enter the horse name: Barbaro ENTER
Enter the age: 3 ENTER
Barbaro is 3 years old.
```

Everything seems to be working okay. What will happen if the name of a horse has more than one word, such as *Sea Biscuit*? The code will not work because only the first word is assigned to the `String` variable `horseName`. Remember that the default delimiter is the white space, so the blank space after the first word is treated as the end of the first input. Here's the result when you enter *Sea Biscuit*:

```
Enter the horse name: Sea Biscuit ENTER
Enter the age: java.util.InputMismatchException
at java.util.Scanner.throwFor(Scanner.java:819)
at java.util.Scanner.next(Scanner.java:1431)
at java.util.Scanner.nextInt(Scanner.java:2040)
...
```

Only the first four lines of error messages are shown here.

The most reasonable solution here is to change the delimiter to the line separator, as described in Section 2.4.4. Here's how:

```
Scanner scanner = new Scanner(System.in);
scanner.useDelimiter(System.getProperty("line.separator"));

//the rest is the same
```

```
Enter the horse name: Sea Biscuit 
Enter the age: 3 
Sea Biscuit is 3 years old.
```

For most situations, using the line separator as the delimiter and inputting one value per input line are the best approach. We can, however, use any string for the delimiter. So, for example, we can delimit the input values with a character such as the pound sign (#), provided, of course, that the pound sign does not occur in the actual input values.

Things to Remember



To input more than one string and primitive numerical data, set the line separator as the delimiter and input one value per input line.

Instead of using the data type specific methods such as `nextInt`, `nextDouble`, and others of the `Scanner` class, we can input a numerical value in a string format and convert it to an appropriate data type by ourselves. For example, we can use the class method `parseInt` of the `Integer` class to convert a string to an `int`. Here's a statement that converts "14" to an `int` value 14:

```
int num = Integer.parseInt("14");
```

So, the statement

```
int num = Integer.parseInt(scanner.next());
```

is equivalent to

```
int num = scanner.nextInt();
```

Passing a string that cannot be converted to an `int` (e.g., "12b") will result in an error. The conversion method is not particularly useful or necessary with the scanner, but it can be when the input source is different from the scanner. Other common conversion methods are `parseDouble`, `parseFloat`, and `parseLong` of the `Double`, `Float`, and `Long` classes, respectively.

We close this section by presenting a sample program that extends the Ch3Circle3 class by accepting the radius of a circle as an input. Here's the program:

```

/*
Chapter 3 Sample Program: Compute Area and Circumference with
                        formatting and standard I/O

File: Ch3Circle4.java
*/

import java.text.*;
import java.util.*;

class Ch3Circle4 {

    public static void main(String[] args) {

        final double PI = 3.14159;
        final String TAB = "\t";
        final String NEWLINE = "\n";

        double radius, area, circumference;

        Scanner scanner = new Scanner(System.in);

        DecimalFormat df = new DecimalFormat("0.000");

        System.out.println("Enter radius: ");
        radius = scanner.nextDouble( );

        //compute the area and circumference
        area          = PI * radius * radius;
        circumference = 2.0 * PI * radius;

        //Display the results
        System.out.println(
            "Given Radius: " + TAB + df.format(radius) + NEWLINE +
            "Area:          " + TAB + df.format(area) + NEWLINE +
            "Circumference: " + TAB + df.format(circumference));
    }
}

```



1. Write a code to input the height of a user in feet (int) and inches (int).
2. Write a code to input the full name of a person and his or her age. The full name of a person includes the first name and the last name.
3. Write a code that creates a Scanner object and sets its delimiter to the pound sign.

3.6 | The Math Class

Using only the arithmetic operators to express numerical computations is very limiting. Many computations require the use of mathematical functions. For example, to express the mathematical formula

$$\frac{1}{2} \sin \left(x - \frac{\pi}{\sqrt{y}} \right)$$

we need the trigonometric sine and square root functions. The `Math` class in the `java.lang` package contains class methods for commonly used mathematical functions. Table 3.7 is a partial list of class methods available in the `Math` class. The class also has two class constants `PI` and `E` for π and the natural number e , respectively. Using the `Math` class constant and methods, we can express the preceding formula as

```
(1.0 / 2.0) * Math.sin( x - Math.PI / Math.sqrt(y) )
```

Table 3.7 `Math` class methods for commonly used mathematical functions

Class Method	Argument Type	Result Type	Description	Example
<code>abs(a)</code>	<code>int</code>	<code>int</code>	Returns the absolute value of a.	<code>abs(10) → 10</code> <code>abs(-5) → 5</code>
	<code>long</code>	<code>long</code>	Returns the absolute long value of a.	
	<code>float</code>	<code>float</code>	Returns the absolute float value of a.	
	<code>double</code>	<code>double</code>	Returns the absolute double value of a.	
<code>acos(a)[†]</code>	<code>double</code>	<code>double</code>	Returns the arccosine of a.	<code>acos(-1) → 3.14159</code>
<code>asin(a)[†]</code>	<code>double</code>	<code>double</code>	Returns the arcsine of a.	<code>asin(1) → 1.57079</code>
<code>atan(a)[†]</code>	<code>double</code>	<code>double</code>	Returns the arctangent of a.	<code>atan(1) → 0.785398</code>
<code>ceil(a)</code>	<code>double</code>	<code>double</code>	Returns the smallest whole number greater than or equal to a.	<code>ceil(5.6) → 6.0</code> <code>ceil(5.0) → 5.0</code> <code>ceil(-5.6) → -5.0</code>
<code>cos(a)[†]</code>	<code>double</code>	<code>double</code>	Returns the trigonometric cosine of a.	<code>cos(π/2) → 0.0</code>
<code>exp(a)</code>	<code>double</code>	<code>double</code>	Returns the natural number e (2.718...) raised to the power of a.	<code>exp(2) → 7.389056099</code>

Table 3.7 Math class methods for commonly used mathematical functions (Continued)

Class Method	Argument Type	Result Type	Description	Example
<code>floor(a)</code>	double	double	Returns the largest whole number less than or equal to a .	<code>floor(5.6) → 5.0</code> <code>floor(5.0) → 5.0</code> <code>floor(-5.6)</code> → -6.0
<code>log(a)</code>	double	double	Returns the natural logarithm (base e) of a .	<code>log(2.7183)</code> → 1.0
<code>max(a, b)</code>	int	int	Returns the larger of a and b .	<code>max(10,20)</code> → 20
<code>min(a, b)</code>	long	long	Same as above.	<code>min(10,20)</code> → 10
	float	float	Same as above.	
	int	int	Returns the smaller of a and b .	
<code>pow(a, b)</code>	long	long	Same as above.	<code>pow(2.0,3.0)</code> → 8.0
	float	float	Same as above.	
	double	double	Returns the number a raised to the power of b .	
<code>random()</code>	<none>	double	Generates a random number greater than or equal to 0.0 and less than 1.0.	
<code>round(a)</code>	float	int	Returns the int value of a rounded to the nearest whole number.	<code>round(5.6) → 6</code> <code>round(5.4) → 5</code> <code>round(-5.6)</code> → -6
	double	long	Returns the float value of a rounded to the nearest whole number.	
<code>sin(a)[†]</code>	double	double	Returns the trigonometric sine of a .	<code>sin($\pi/2$)</code> → 1.0
<code>sqrt(a)</code>	double	double	Returns the square root of a .	<code>sqrt(9.0) → 3.0</code>
<code>tan(a)[†]</code>	double	double	Returns the trigonometric tangent of a .	<code>tan($\pi/4$)</code> → 1.0
<code>toDegrees</code>	double	double	Converts the given angle in radians to degrees.	<code>toDegrees($\pi/4$)</code> → 45.0
<code>toRadians</code>	double	double	Reverse of toDegrees .	<code>toRadians(90.0)</code> → 1.5707963

[†]All trigonometric functions are computed in radians.

Notice how the class methods and class constants are referred to in the expression. The syntax is

```
<class name> . <method name> ( <arguments> )
```

or

```
<class name> . <class constant>
```

Let's conclude this section with a sample program. Today is the final meet of the women's rowing team against the arch rival university before the upcoming Division I NCAA championship. The cheerleaders of the rival team hoisted their school flag on the other shore of the river to boost their moral. Not to be outdone, we want to hoist our school flag, too. To bring the Goddess of Victory to our side, we want our pole to be taller than theirs. Since they won't let us, we can't find the height of their pole by actually measuring it. We can, however, determine the height without actually measuring it if we know the distance b to their flagpole. We can use the tangent of angle to determine the pole's height h as follows:

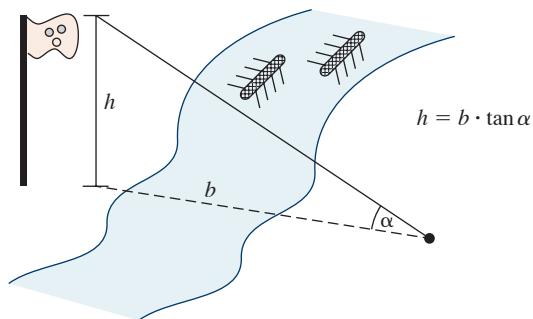

Unfortunately, there's no means for us to go across the river to find out the distance b . After a moment of deep meditation, it hits us that there's no need to go across the river. We can determine the pole's height by measuring angles from two points on this side of the riverbank, as shown below:

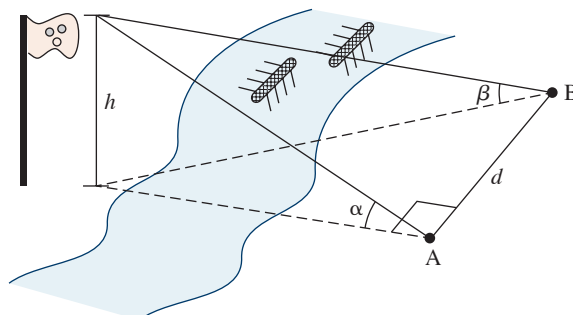

And the equation to compute the height h is

$$h = \frac{d \sin \alpha \sin \beta}{\sqrt{\sin(\alpha + \beta) \sin(\alpha - \beta)}}$$

Once we have this equation, all that's left is to put together a Java program. Here's the program:

```

/*
   Chapter 3 Sample Program: Estimate the Pole Height
   File: Ch3PoleHeight.java
*/
import java.text.*;
import java.util.*;

class Ch3PoleHeight {
    public static void main( String[] args ) {

        double height;           //height of the pole
        double distance;         //distance between points A and B
        double alpha;            //angle measured at point A
        double beta;             //angle measured at point B
        double alphaRad;         //angle alpha in radians
        double betaRad;          //angle beta in radians

        Scanner scanner = new Scanner(System.in);
        scanner.useDelimiter(System.getProperty("line.separator"));

        //Get three input values
        System.out.print("Angle alpha (in degrees):");
        alpha = scanner.nextDouble();

        System.out.print("Angle beta (in degree):");
        beta = scanner.nextDouble();

        System.out.print("Distance between points A and B (ft):");
        distance = scanner.nextDouble();

        //compute the height of the tower
        alphaRad = Math.toRadians(alpha);
        betaRad = Math.toRadians(beta);

        height = ( distance * Math.sin(alphaRad) * Math.sin(betaRad) )
                /
                Math.sqrt( Math.sin(alphaRad + betaRad) *
                           Math.sin(alphaRad - betaRad) );
    }
}

```

```

DecimalFormat df = new DecimalFormat("0.000");

System.out.println("\n\n Estimating the height of the pole"
    + "\n\n"
    + "Angle at point A (deg):      " + df.format(alpha) + "\n"
    + "Angle at point B (deg):      " + df.format(beta) + "\n"
    + "Distance between A and B (ft): " + df.format(distance) + "\n"
    + "Estimated height (ft):       " + df.format(height));
    }
}

```



1. What's wrong with the following?
 - a. `y = (1/2) * Math.sqrt(X);`
 - b. `y = sqrt(38.0);`
 - c. `y = Math.exp(2, 3);`
 - d. `y = math.sqrt(b*b - 4*a*c) / (2 * a);`
2. If another programmer writes the following statements, do you suspect any misunderstanding on the part of this programmer? What will be the value of `y`?
 - a. `y = Math.sin(360);`
 - b. `y = Math.cos(45);`

3.7 Random Number Generation

In many computer applications, especially in simulation and games, we need to generate random numbers. For example, to simulate a roll of dice, we can generate an integer between 1 and 6. In this section, we explain how to generate random numbers using the `Random` class from the `java.util` package. (Alternatively, we can use the `random` method of the `Math` class to generate random numbers, but it is more difficult to use than the `Random` class).

For most applications, the random numbers we want to generate are integers. To generate random integers, we use the `nextInt` method of the `Random` class. Here's an example:

```

import java.util.*;
...
Random random = new Random( );

int num = random.nextInt( );

```

The `nextInt` method returns an `int` value, that is any value between -2147483648 and 2147483647 (see Table 3.1). To restrict range of possible values, we can use the second form of the `nextInt` method in which we pass an argument that specifies the upper bound of the range. The lower bound is set to 0. To generate a random integer between 0 and 10, for example, we write as follows:

```
int num = random.nextInt(11);
```

Notice that the argument we pass is 11, not 10. The argument we pass to the method specifies the total number of possible values, starting from 0. So passing the value of 11 specifies that we are getting one of the 11 possible values, ranging from 0 to 10.

Often we want the lower bound of the possible range to be other than 0. There is no method in the `Random` class that allows us to specify both the lower bound. It is possible, however, to generate any number between *min* and *max* where *min* is greater than 0? Suppose, for example, we want a number between 1 and 6. We can first generate a number between 0 and 5 and then add 1 to the result as

```
int num = random.nextInt(6) + 1;
```

This generates an integer
between 0 and 5, inclusive.

Let's derive a formula for the general case. To generate a random integer in the range of $[min, max]$ where $0 \leq min < max$, we write

```
int num = random.nextInt(max-min+1) + min;
```

This generates an integer between
0 and (max-min), inclusive.

The expression `random.nextInt(max-min+1)` returns an integer between 0 and $(max-min)$. By adding *min* to this value, the final result will then be a value between $0 + min = min$ and $(max - min) + min = max$, as desired.



The `nextInt` (and other methods) in the `Random` class is called a *pseudorandom number generator* because the number is not truly random. When we call the method repeatedly, eventually the numbers generated will repeat themselves. Therefore, theoretically the generated numbers are not random; but for all practical purposes, they are random enough.

Let's write a short program that selects a winner among the party goers of the annual spring fraternity dance. The party goers will receive numbers $M + 1$, $M + 2$, $M + 3$, and so on, as they enter the house. The starting value M is determined by the fraternity president. The last number assigned is $M + N$ if there are N party goers. At the end of the party, we run the program that will randomly select the winning number from the range of $M + 1$ and $M + N$. Here's the program:

```
*/  
  
Chapter 3 Sample Program: Select the Winning Number using the Random class  
File: Ch3SelectWinner.java  
  
*/  
  
import java.util.*;  
  
class Ch3SelectWinner {  
    public static void main(String[] args) {  
        int startingNumber; //the starting number  
        int count; //the number of party goers  
        int winningNumber; //the winner  
        int min, max; //the range of random numbers to generate  
  
        Random random = new Random(); //random number generator  
        Scanner scan = new Scanner(System.in);  
  
        //Get two input values  
        System.out.print("Enter the starting number M: ");  
        startingNumber = scan.nextInt ();  
  
        System.out.print("Enter the number of party goers: ");  
        count = scan.nextInt();  
  
        //select the winner  
        min = startingNumber + 1;  
        max = startingNumber + count;  
  
        winningNumber = random.nextInt(max-min+1) + min;  
  
        System.out.println("\nThe Winning Number is " + winningNumber);  
    }  
}
```



1. What are the possible minimum and the maximum numbers assigned to `num` by the following statement?

```
int num = random.nextInt(15);
```

2. Write a statement that assigns a random number between 1 and 4, inclusive, to an integer variable `num`.
3. Write a statement that assigns a random number between `min` and `max`, inclusive, where $0 \leq min < max$, to an integer variable `num`.

3.8 | The `GregorianCalendar` Class

In Chapter 2, we introduced the `java.util.Date` class to represent a specific instant in time. Notice that we are using here the more concise expression “the `java.util.Date` class” to refer to a class from a specific package instead of the longer expression “the `Date` class from the `java.util` package.” This shorter version is our preferred way of notation when we need or want to identify the package to which the class belongs.

Things to Remember



*When we need to identify the specific package to which a class belongs, we will commonly use the concise expression with the full path name, such as **`java.util.Date`**, instead of writing “the **`Date`** class from the **`java.util`** package.”*

Gregorian-
Calendar

In addition to this class, we have a very useful class named `java.util.GregorianCalendar` in manipulating calendar information such as year, month, and day. We can create a new `GregorianCalendar` object that represents today as

```
GregorianCalendar today = new GregorianCalendar( );
```

or a specific day, say, July 4, 1776, by passing year, month, and day as the parameters as

```
GregorianCalendar independenceDay =
    new GregorianCalendar(1776, 6, 4);
```

The value of 6
means July.

No, the value of 6 as the second parameter is not an error. The first month of a year, January, is represented by 0, the second month by 1, and so forth. To avoid

Table 3.8 Constants defined in the `Calendar` class for retrieved different pieces of calendar/time information

Constant	Description
<code>YEAR</code>	The year portion of the calendar date
<code>MONTH</code>	The month portion of the calendar date
<code>DATE</code>	The day of the month
<code>DAY_OF_MONTH</code>	Same as <code>DATE</code>
<code>DAY_OF_YEAR</code>	The day number within the year
<code>DAY_OF_MONTH</code>	The day number within the month
<code>DAY_OF_WEEK</code>	The day of the week (Sun—1, Mon—2, etc.)
<code>WEEK_OF_YEAR</code>	The week number within the year
<code>WEEK_OF_MONTH</code>	The week number within the month
<code>AM_PM</code>	The indicator for AM or PM (AM—0 and PM—1)
<code>HOUR</code>	The hour in 12-hour notation
<code>HOUR_OF_DAY</code>	The hour in 24-hour notation
<code>MINUTE</code>	The minute within the hour

confusion, we can use constants defined for months in the superclass `Calendar` (`GregorianCalendar` is a subclass of `Calendar`). Instead of remembering that the value 6 represents July, we can use the defined constant `Calendar.JULY` as

```
GregorianCalendar independenceDay =
    new GregorianCalendar(1776, Calendar.JULY, 4);
```

Table 3.8 explains the use of some of the more common constants defined in the `Calendar` class.

When the date and time are February 13, 2008, 13:30 p.m. and we run the `Ch3TestCalendar` program, we will see the result shown in Figure 3.4.

```
Wed Feb 13:30:51 PST 2008
YEAR:          2008
MONTH:         1
DATE:          13
DAY_OF_YEAR:   44
DAY_OF_MONTH:  13
DAY_OF_WEEK:   4
WEEK_OF_YEAR:  7
WEEK_OF_MONTH: 3
AM_PM:         1
HOUR:          1
HOUR_OF_DAY:  13
MINUTE:        30
```

Figure 3.4 Result of running the `Ch3TestCalendar` program at February 13, 2008, 13:30 p.m.

```

/*
Chapter 3 Sample Program: Display Calendar Info
File: Ch3TestCalendar.java
*/
import java.util.*;

class Ch3TestCalendar {

    public static void main(String[] args) {

        GregorianCalendar cal = new GregorianCalendar();

        System.out.println(cal.getTime());
        System.out.println("");

        System.out.println("YEAR:          " + cal.get(Calendar.YEAR));
        System.out.println("MONTH:         " + cal.get(Calendar.MONTH));
        System.out.println("DATE:         " + cal.get(Calendar.DATE));

        System.out.println("DAY_OF_YEAR:   "
            + cal.get(Calendar.DAY_OF_YEAR));
        System.out.println("DAY_OF_MONTH:  "
            + cal.get(Calendar.DAY_OF_MONTH));
        System.out.println("DAY_OF_WEEK:   "
            + cal.get(Calendar.DAY_OF_WEEK));
        System.out.println("WEEK_OF_YEAR:  "
            + cal.get(Calendar.WEEK_OF_YEAR));
        System.out.println("WEEK_OF_MONTH: "
            + cal.get(Calendar.WEEK_OF_MONTH));

        System.out.println("AM_PM:        " + cal.get(Calendar.AM_PM));
        System.out.println("HOUR:         " + cal.get(Calendar.HOUR));
        System.out.println("HOUR_OF_DAY:  "
            + cal.get(Calendar.HOUR_OF_DAY));
        System.out.println("MINUTE:       " + cal.get(Calendar.MINUTE));
    }
}

```

Notice that the first line in the output shows the full date and time information. The full date and time information can be accessed by calling the calendar object's `getTime` method. This method returns the same information as a `Date` object.

`getTime`

Notice also that we get only the numerical values when we retrieve the day of the week or month information. We can spell out the information by using the `SimpleDateFormat` class. Since the constructor of the `SimpleDateFormat` class accepts only the `Date` object, first we need to convert a `GregorianCalendar` object to an equivalent `Date` object by calling its `getTime` method. For example, here's how

we can display the day of the week on which our Declaration of Independence was adopted in Philadelphia:

```

/*
   Chapter 3 Sample Program: Day of the week the Declaration of
                           Independence was adopted

   File: Ch3IndependenceDay.java
*/
import java.util.*;
import java.text.*;

class Ch3IndependenceDay {
    public static void main(String[] args) {
        GregorianCalendar independenceDay
            = new GregorianCalendar(1776, Calendar.JULY, 4);
        SimpleDateFormat sdf = new SimpleDateFormat("EEEE");
        System.out.println("It was adopted on "
            + sdf.format(independenceDay.getTime()));
    }
}

```

Let's finish the section with a sample program that extends the `Ch3IndependenceDay` program. We will allow the user to enter the year, month, and day; and we will reply with the day of the week of the given date (our birthday, grandparent's wedding day, and so on). Here's the program:

```

/*
   Chapter 3 Sample Program: Find the Day of Week of a Given Date

   File: Ch3FindDayOfWeek.java
*/
import java.util.*;
import java.text.*;

class Ch3FindDayOfWeek {
    public static void main(String[] args) {
        int year, month, day;
        GregorianCalendar cal;
        SimpleDateFormat sdf;

```



```

Scanner scanner = new Scanner(System.in);
scanner.useDelimiter(System.getProperty("line.separator"));

System.out.print("Year (yyyy): ");
year = scanner.nextInt();

System.out.print("Month (1-12): ");
month = scanner.nextInt();

System.out.print("Day (1-31): ");
day = scanner.nextInt();

cal = new GregorianCalendar(year, month-1, day);
sdf = new SimpleDateFormat("EEEE");

System.out.println("");
System.out.println("Day of Week: " + sdf.format(cal.getTime()));
}
}
}

```

Notice that we are allowing the user to enter the month as an integer between 1 and 12, so we need to subtract 1 from the entered data in creating a new `GregorianCalendar` object.



The Gregorian calendar system was adopted by England and its colonies, including the colonial United States, in 1752. So the technique shown here works only after this adoption. For a fascinating story about calendars, visit

<http://webexhibits.org/calendars/year-countries.html>



Running `Ch3IndependenceDay` will tell you that our venerable document was signed on Thursday. History textbooks will say something like “the document was formally adopted July 4, 1776, on a bright, but cool Philadelphia day” but never the day of the week. Well, now you know. See how useful Java is? By the way, the document was adopted by the Second Continental Congress on July 4, but the actual signing did not take place until August 2 (it was Friday—what a great reason for a TGIF party) after the approval of all 13 colonies. For more stories behind the Declaration of Independence, visit

<http://www.ushistory.org/declaration/>

3.9 Sample Development

Loan Calculator

In this section, we develop a simple loan calculator program. We develop this program by using an incremental development technique, which develops the program in small incremental steps. We start out with a bare-bones program and gradually build up the program by adding more and more code to it. At each incremental step, we design, code, and test the program before moving on to the next step. This methodical development of a program allows us to focus our attention on a single task at each step, and this reduces the chance of introducing errors into the program.

Problem Statement

The next time you buy a new TV or a stereo, watch out for those “0% down, 0% interest until next July” deals. Read the fine print, and you’ll notice that if you don’t make the full payment by the end of a certain date, hefty interest will start accruing. You may be better off to get an ordinary loan from the beginning with a cheaper interest rate. What matters most is the total payment (loan amount plus total interest) you’ll have to make. To compare different loan deals, let’s develop a loan calculator. Here’s the problem statement:

Write a loan calculator program that computes both monthly and total payments for a given loan amount, annual interest rate, and loan period.

Overall Plan

Our first task is to map out the overall plan for development. We will identify classes necessary for the program and the steps we will follow to implement the program. We begin with the outline of program logic. For a simple program such as this one, it is kind of obvious; but to practice the incremental development, let’s put down the outline of program flow explicitly. We can express the program flow as having three tasks:

program
tasks

1. Get three input values: **loanAmount**, **interestRate**, and **loanPeriod**.
2. Compute the monthly and total payments.
3. Output the results.

Having identified the three major tasks of the program, we now identify the classes we can use to implement the three tasks. For input and output, we continue to use the **Scanner** class and **System.out (PrintStream)**. For computing the monthly and total payments, there are no standard classes that will provide such computation, so we have to write our own code.

The formula for computing the monthly payment can be found in any mathematics book that covers geometric sequences. It is

$$\text{Monthly payment} = \frac{L \times R}{1 - [1/(1 + R)]^N}$$

3.9 Sample Development—continued

where L is the loan amount, R is the monthly interest rate, and N is the number of payments. The monthly rate R is expressed in a fractional value, for example, 0.01 for 1 percent monthly rate. Once the monthly payment is derived, the total payment can be determined by multiplying the monthly payment by the number of months the payment is made. Since the formula includes exponentiation, we will have to use the **pow** method of the **Math** class.

Let's summarize what we have decided so far in a design document:

program
classes

Design Document: LoanCalculator	
Class	Purpose
LoanCalculator	The main class of the program.
Scanner	The class is used to get three input values: loan amount, annual interest rate, and loan period.
PrintStream (System.out)	System.out is used to display the input values and two computed results: monthly payment and total payment.
Math	The pow method is used to evaluate exponentiation in the formula for computing the monthly payment. This class is from java.lang. Note: You don't have to import java.lang. The classes in java.lang are available to a program without importing.

The program diagram based on the classes listed in the design document is shown in Figure 3.5. Keep in mind that this is only a preliminary design. The preliminary document is really a working document that we will modify and expand as we progress through the development steps.

Before we can actually start our development, we must sketch the steps we will follow to implement the program. There is more than one possible sequence of steps to implement a program, and the number of possible sequences will increase as the program becomes more complex. For this program, we will implement the program in four steps:

develop-
ment steps

1. Start with code to accept three input values.
2. Add code to output the results.
3. Add code to compute the monthly and total payments.
4. Update or modify code and tie up any loose ends.

Notice how the first three steps are ordered. Other orders are possible to develop this program. So why did we choose this particular order? The main reason is our desire to defer the most difficult task until the end. It's possible, but if we implement the computation part in the second incremental step, then we need to code some temporary output routines to verify that the computation is done correctly. However, if we implement the

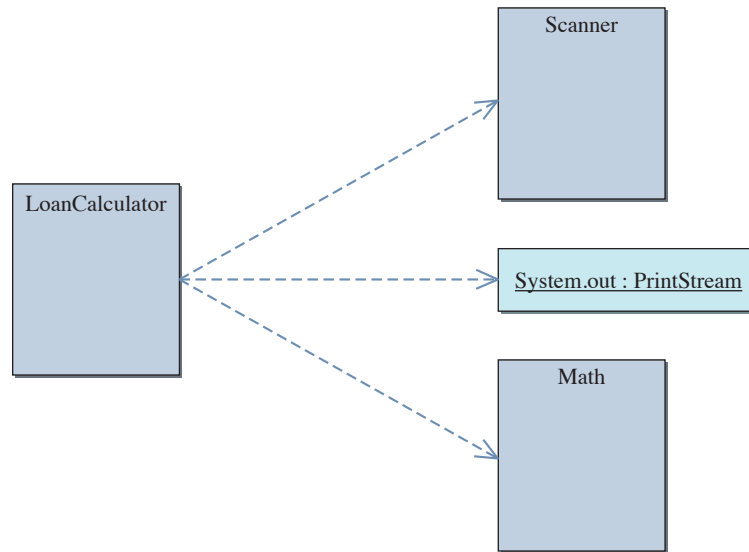

Figure 3.5 The object diagram for the program **LoanCalculator**.

real output routines before implementing the computation routines, then there is no need for us to worry about temporary output routines. As for step 1 and step 2, their relative order does not matter much. We simply chose to implement the input routine before the output routine because input comes before output in the program.

Step 1 Development: Input Three Data Values

step 1
design

The next task is to determine how we will accept the input values. The problem statement does not specify the exact format of input, so we will decide that now. Based on how people normally refer to loans, the input values will be accepted in the following format:

Input	Format	Data Type
Loan amount	In dollars and cents (for example, 15000.00)	double
Annual interest rate	In percent (for example, 12.5)	double
Loan period	In years (for example, 30)	int

Be aware that we need to convert the annual interest rate to the monthly interest rate and the input value loan period to the number of monthly payments, to use the given formula. In this case, the conversion is very simple, but even if the conversion routines were more complicated, we must do the conversion. It is not acceptable to ask users to

3.9 Sample Development—continued

enter an input value that is unnatural to them. For example, people do not think of interest rates in fractional values such as 0.07. They think of interest in terms of percentages such as 7 percent. Computer programs work for humans, not the other way round. Programs we develop should not support an interface that is difficult and awkward for humans to use.

When the user inputs an invalid value, for example, an input string value that cannot be converted to a numerical value or that converts to a negative number, the program should respond accordingly, such as by printing an error message. We do not possess enough skills to implement such a robust program yet, so we will make the following assumptions: (1) The input values are nonnegative numbers, and (2) the loan period is a whole number.

One important objective of this step is to verify that the input values are read in correctly by the program. To verify this, we will echo-print the input values to

step 1 code

System.out.

Here's our step 1 program:

```

/*
  Chapter 3 Sample Development: Loan Calculator (Step 1)
  File: Step1/Ch3LoanCalculator.java
  Step 1: Input Data Values
*/
import java.util.*;

class Ch3LoanCalculator {
    public static void main(String[] args) {

        double loanAmount,
            annualInterestRate;

        int loanPeriod;

        Scanner scanner = new Scanner(System.in);
        scanner.useDelimiter(System.getProperty("line.separator"));

        //get input values
        System.out.print("Loan Amount (Dollars+Cents): ");
        loanAmount = scanner.nextDouble();

        System.out.print("Annual Interest Rate (e.g., 9.5): ");
        annualInterestRate = scanner.nextDouble();
    }
}

```

```

System.out.print("Loan Period - # of years: ");
loanPeriod = scanner.nextInt();

//echo print the input values
System.out.println("");
System.out.println("Loan Amount:          $" + loanAmount);
System.out.println("Annual Interest Rate: "
                  + annualInterestRate + "%");
System.out.println("Loan Period (years): " + loanPeriod);
}
}

```

step 1 test

To verify the input routine is working correctly, we run the program multiple times and enter different sets of data. We make sure the values are displayed in the standard output window as entered.

step 2
design**Step 2 Development: Output Values**

The second step is to add code to display the output values. We will use the standard output window for displaying output values. We need to display the result in a layout that is meaningful and easy to read. Just displaying numbers such as the following is totally unacceptable.

```
132.151.15858.1
```

We must label the output values so the user can tell what the numbers represent. In addition, we must display the input values with the computed result so it will not be meaningless. Which of the two shown in Figure 3.6 do you think is more meaningful? The output format of this program will be

```

For
Loan Amount:          $ <amount>
Annual Interest Rate: <annual interest rate> %
Loan Period (years): <year>

Monthly payment is $ <monthly payment>
TOTAL payment is $ <total payment>

```

with **<amount>**, **<annual interest rate>**, and others replaced by the actual figures.

3.9 Sample Development—continued

Only the computed values (and their labels) are shown.

Monthly payment:	\$ 143.47
Total payment:	\$ 17216.50

Both the input and computed values (and their labels) are shown.

For	
Loan Amount:	\$ 10000.00
Annual Interest Rate:	12.0%
Loan Period (years):	10
Monthly payment is	\$ 143.47
TOTAL payment is	\$ 17216.50

Figure 3.6 Two different display formats, one with input values displayed and the other with only the computed values displayed.

Since the computations for the monthly and total payments are not yet implemented, we will use the following dummy assignment statements:

```
monthlyPayment = 135.15;
totalPayment   = 15858.10;
```

We will replace these statements with the real ones in the next step.

step 2 code

Here's our step 2 program with the newly added portion surrounded by a rectangle and white background:

```
/*
Chapter 3 Sample Development: Loan Calculator (Step 2)
File: Step2/Ch3LoanCalculator.java
Step 2: Display the Results
*/
import java.util.*;
class Ch3LoanCalculator {
    public static void main(String[] args) {
        double loanAmount,
               annualInterestRate;
        double monthlyPayment,
               totalPayment;
        int loanPeriod;
```

```

Scanner scanner = new Scanner(System.in);
scanner.useDelimiter(System.getProperty("line.separator"));

//get input values
System.out.print("Loan Amount (Dollars+Cents): ");
loanAmount = scanner.nextDouble();

System.out.print("Annual Interest Rate (e.g., 9.5): ");
annualInterestRate = scanner.nextDouble();

System.out.print("Loan Period - # of years: ");
loanPeriod = scanner.nextInt();

//compute the monthly and total payments
monthlyPayment = 132.15;
totalPayment = 15858.10;

//display the result
System.out.println("");
System.out.println("Loan Amount:          $" + loanAmount);
System.out.println("Annual Interest Rate:"
                  + annualInterestRate + "%");
System.out.println("Loan Period (years): " + loanPeriod);

System.out.println("\n"); //skip two lines
System.out.println("Monthly payment is   $" + monthlyPayment);
System.out.println("  TOTAL payment is   $" + totalPayment);
}
}

```

step 2 test

To verify the output routine is working correctly, we run the program and verify the layout. Most likely, we have to run the program several times to fine-tune the arguments for the **println** methods until we get the layout that looks clean and nice on the screen.

Step 3 Development: Compute Loan Amount**step 3 design**

We are now ready to complete the program by implementing the formula derived in the design phase. The formula requires the monthly interest rate and the number of monthly payments. The input values to the program, however, are the annual interest rate and the loan period in years. So we need to convert the annual interest rate to a monthly interest rate and the loan period to the number of monthly payments. The two input values are converted as

```

monthlyInterestRate = annualInterestRate / 100.0 / MONTHS_IN_YEAR;
numberOfPayments    = loanPeriod * MONTHS_IN_YEAR;

```

3.9 Sample Development—continued

where **MONTHS_IN_YEAR** is a symbolic constant with value **12**. Notice that we need to divide the input annual interest rate by 100 first because the formula for loan computation requires that the interest rate be a fractional value, for example, 0.01, but the input annual interest rate is entered as a percentage point, for example, 12.0. Please read Exercise 26 on page 147 for information on how the monthly interest rate is derived from a given annual interest rate.

The formula for computing the monthly and total payments can be expressed as

```
monthlyPayment = (loanAmount * monthlyInterestRate)
                  /
                  (1 - Math.pow( 1 / (1 + monthlyInterestRate),
                                numberOfPayments) );

totalPayment = monthlyPayment * numberOfPayments;
```

step 3 code

Let's put in the necessary code for the computations and complete the program. Here's our program:

```
/*
Chapter 3 Sample Development: Loan Calculator (Step 3)
File: Step3/Ch3LoanCalculator.java
Step 3: Display the Results
*/
import java.util.*;

class Ch3LoanCalculator {
    public static void main(String[] args) {
        final int MONTHS_IN_YEAR = 12;

        double loanAmount,
               annualInterestRate;

        double monthlyPayment,
               totalPayment;

        double monthlyInterestRate;

        int loanPeriod;
```

```

int    numberOfPayments;

Scanner scanner = new Scanner(System.in);
scanner.useDelimiter(System.getProperty("line.separator"));

//get input values
System.out.print("Loan Amount (Dollars+Cents): ");
loanAmount = scanner.nextDouble();

System.out.print("Annual Interest Rate (e.g., 9.5): ");
annualInterestRate = scanner.nextDouble();

System.out.print("Loan Period - # of years: ");
loanPeriod = scanner.nextInt();

//compute the monthly and total payments
monthlyInterestRate = annualInterestRate / MONTHS_IN_YEAR / 100;
numberOfPayments    = loanPeriod * MONTHS_IN_YEAR;

monthlyPayment = (loanAmount * monthlyInterestRate)/
                 (1 - Math.pow(1/(1 + monthlyInterestRate),
                               numberOfPayments ) );

totalPayment = monthlyPayment * numberOfPayments;

//display the result
System.out.println("");
System.out.println("Loan Amount:           $" + loanAmount);
System.out.println("Annual Interest Rate: "
                  + annualInterestRate + "%");
System.out.println("Loan Period (years):  " + loanPeriod);

System.out.println("\n"); //skip two lines
System.out.println("Monthly payment is   $" + monthlyPayment);
System.out.println("  TOTAL payment is   $" + totalPayment);
}
}

```

step 3 test

After the program is coded, we need to run the program through a number of tests. Since we made the assumption that the input values must be valid, we will test the program only for valid input values. If we don't make that assumption, then we need to test that the program will respond correctly when invalid values are entered. We will perform such testing beginning in Chapter 5. To check that this program produces correct results, we can run the program with the following input values. The right two columns show the correct results. Try other input values as well.

3.9 Sample Development—continued

Input			Output (shown up to three decimal places only)	
Loan Amount	Annual Interest Rate	Loan Period (Years)	Monthly Payment	Total Payment
10000	10	10	132.151	15858.088
15000	7	15	134.824	24268.363
10000	12	10	143.471	17216.514
0	10	5	0.000	0.000
30	8.5	50	0.216	129.373

Step 4 Development: Finishing Up

step 4 design

We finalize the program in the last step by making any necessary modifications or additions. We will make two additions to the program. The first is necessary while the second is optional but desirable. The first addition is the inclusion of a program description. One of the necessary features of any nontrivial program is the description of what the program does for the user. We will print out a description at the beginning of the program to **System.out**. The second addition is the formatting of the output values. We will format the monthly and total payments to two decimal places, using a **DecimalFormat** object.

step 4 code

Here is our final program:

```

/*
Chapter 3 Sample Development: Loan Calculator (Step 4)
File: Step4/Ch3LoanCalculator.java
Step 4: Finalize the program
*/
import java.util.*;
import java.text.*;
class Ch3LoanCalculator {
    public static void main(String[] args) {
        final int MONTHS_IN_YEAR = 12;

```

```
double loanAmount,
        annualInterestRate;
```

```
double monthlyPayment,
        totalPayment;
```

```
double monthlyInterestRate;
```

```
int loanPeriod;
```

```
int numberOfPayments;
```

```
Scanner scanner = new Scanner(System.in);
scanner.useDelimiter(System.getProperty("line.separator"));
```

```
DecimalFormat df = new DecimalFormat("0.00");
```

```
//describe the program
```

```
System.out.println("This program computes the monthly and total");
```

```
System.out.println("payments for a given loan amount, annual ");
```

```
System.out.println("interest rate, and loan period.");
```

```
System.out.println("Loan amount in dollars and cents,
                    e.g., 12345.50");
```

```
System.out.println("Annual interest rate in percentage,
                    e.g., 12.75");
```

```
System.out.println("Loan period in number of years, e.g., 15");
```

```
System.out.println("\n"); //skip two lines
```

```
//get input values
```

```
System.out.print("Loan Amount (Dollars+Cents): ");
```

```
loanAmount = scanner.nextDouble( );
```

```
System.out.print("Annual Interest Rate (e.g., 9.5): ");
```

```
annualInterestRate = scanner.nextDouble( );
```

```
System.out.print("Loan Period - # of years: ");
```

```
loanPeriod = scanner.nextInt( );
```

```
//compute the monthly and total payments
```

```
monthlyInterestRate = annualInterestRate / MONTHS_IN_YEAR / 100;
```

```
numberOfPayments = loanPeriod * MONTHS_IN_YEAR;
```

```
monthlyPayment = (loanAmount * monthlyInterestRate) /
                  (1 - Math.pow(1/(1 + monthlyInterestRate),
                                numberOfPayments ) );
```

```
totalPayment = monthlyPayment * numberOfPayments;
```

```
//display the result
```

```
System.out.println("");
```

```
System.out.println("Loan Amount:          $" + loanAmount);
```

3.9 Sample Development—continued

```

System.out.println("Annual Interest Rate: "
                  + annualInterestRate + "%");
System.out.println("Loan Period (years): " + loanPeriod);

System.out.println("\n"); //skip two lines

System.out.println("Monthly payment is $ "
                  + df.format(monthlyPayment));
System.out.println("  TOTAL payment is $ "
                  + df.format(totalPayment));
}
}

```

step 4 test

We repeat the test runs from step 3 and confirm the modified program still runs correctly. Since we have not made any substantial additions or modifications, we fully expect the program to work correctly. However, it is very easy to introduce errors in coding, so even if we think the changes are trivial, we should never skip the testing after even a slight modification.

Things to Remember



Always test after making any additions or modifications to a program, no matter how trivial you think the changes are.

twos complement

3.10 Numerical Representation (Optional)

In this section we explain how integers and real numbers are stored in memory. Although computer manufacturers have used various formats for storing numerical values, today's standard is to use the *twos complement* format for storing integers and the *floating-point* format for real numbers. We describe these formats in this section.

An integer can occupy 1, 2, 4, or 8 bytes depending on which data type (i.e., byte, short, int, or long) is declared. To make the examples easy to follow, we will use 1 byte (= 8 bits) to explain twos complement form. The same principle applies to 2, 4, and 8 bytes. (They just utilize more bits.)

The following table shows the first five and the last four of the 256 positive binary numbers using 8 bits. The right column lists their decimal equivalents.

8-Bit Binary Number	Decimal Equivalent
00000000	0
00000001	1
00000010	2
00000011	3
00000100	4
...	
11111100	252
11111101	253
11111110	254
11111111	255

sign bit

Using 8 bits, we can represent positive integers from 0 to 255. Now let's see the possible range of negative and positive numbers that we can represent, using 8 bits. We can designate the leftmost bit as a *sign bit*: 0 means positive and 1 means negative. Using this scheme, we can represent integers from -127 to $+127$ as shown in the following table:

8-Bit Binary Number (with a Sign Bit)	Decimal Equivalent
0 0000000	+0
0 0000001	+1
0 0000010	+2
...	
0 1111111	+127
1 0000000	-0
1 0000001	-1
...	
1 1111110	-126
1 1111111	-127

Notice that zero has two distinct representations ($+0 = 00000000$ and $-0 = 10000000$), which adds complexity in hardware design. Twos complement format avoids this problem of duplicate representations for zero. In twos complement format, all positive numbers have zero in their leftmost bit. The representation of a negative number is derived by first inverting all the bits (changing 1s to 0s and 0s to

1s) in the representation of the positive number and then adding 1. The following diagram illustrates the process:

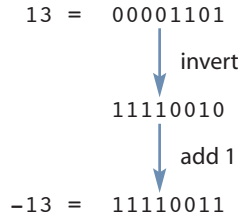

The following table shows the decimal equivalents of 8-bit binary numbers by using twos complement representation. Notice that zero has only one representation.

8-Bit Binary Number (Twos Complement)	Decimal Equivalent
00000000	+0
00000001	+1
00000010	+2
...	
01111111	+127
10000000	-128
10000001	-127
...	
11111110	-2
11111111	-1

floating-point

Now let's see how real numbers are stored in memory in *floating-point* format. We present only the basic ideas of storing real numbers in computer memory here. We omit the precise details of the Institute of Electronics and Electrical Engineers (IEEE) Standard 754 that Java uses to store real numbers.

Real numbers are represented in the computer by using scientific notation. In base-10 scientific notation, a real number is expressed as

$$A \times 10^N$$

where A is a real number and N is an integral exponent. For example, the mass of a hydrogen atom (in grams) is expressed in decimal scientific notation as 1.67339×10^{-24} , which is equal to 0.000000000000000000000000167339.

We use base-2 scientific notation to store real numbers in computer memory. Base-2 scientific notation represents a real number as follows:

$$A \times 2^N$$

The float and double data types use 32 and 64 bits, respectively, with the number A and exponent N stored as follows:

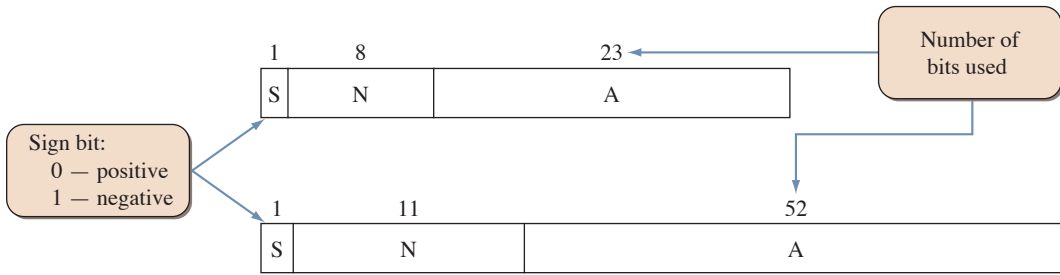

normalized fraction

The value A is a *normalized fraction*, where the fraction begins with a binary point, followed by a 1 bit and the rest of the fraction. (Note: A decimal number has a decimal point; a binary number has a binary point.) The following numbers are sample normalized and unnormalized binary fractions:

Normalized	Unnormalized
1.1010100	1.100111
1.100011	.0000000001
1.101110011	.0001010110

Since a normalized number always start with a 1, this bit does not actually have to be stored. The following diagram illustrates how the A value is stored.



excess format

The sign bit S indicates the sign of a number, so A is stored in memory as an unsigned number. The integral exponent N can be negative or positive. Instead of using two's complement for storing N, we use a format called *excess format*. The 8-bit exponent uses the excess-127 format, and the 11-bit exponent uses the excess-1023 format. We will explain the excess-127 format here. The excess-1023 works similarly. With the excess-127 format, the actual exponent is computed as

$$N - 127$$

Therefore, the number 127 represents an exponent of zero. Numbers less than 127 represent negative exponents, and numbers greater than 127 represent positive exponents. The following diagram illustrates that the number 125 in the exponent field represents $2^{125-127} = 2^{-2}$.

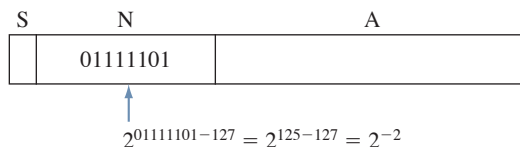

Summary

- A variable is a memory location in which to store a value.
- A variable has a name and a data type.
- A variable must be declared before we can assign a value to it.
- There are six numerical data types in Java: byte, short, int, long, float, and double.
- Object names are synonymous with variables whose contents are memory addresses.
- Numerical data types are called primitive data types, and objects are called reference data types.
- Precedence rules determine the order of evaluating arithmetic expressions.
- Symbolic constants hold values just as variables do, but we cannot change their values.
- The standard classes introduced in this chapter are
 - Math
 - GregorianCalendar
 - DecimalFormat
- System.out is used to output multiple lines of text to the standard output window.
- System.in is used to input a stream of bytes. We associate a Scanner object to System.in to input primitive data type.
- The Math class contains many class methods for mathematical functions.
- The GregorianCalendar class is used in the manipulation of calendar information.
- The DecimalFormat class is used to format numerical data.
- (*Optional*) Twos complement format is used for storing integers, and floating-pointing format is used for storing real numbers.

Key Concepts

variables	assignment conversion
primitive data types	constants
reference data types	standard output
arithmetic expression	standard input
arithmetic operators	echo printing
precedence rules	twos complement (<i>optional</i>)
typecasting	floating point (<i>optional</i>)
implicit and explicit casting	

Chapter 3 Exercises

Review Exercises

1. Suppose we have the following declarations:

```
int i = 3, j = 4, k = 5;
float x = 34.5f, y = 12.25f;
```

Determine the value for each of the following expressions, or explain why it is not a valid expression.

- $(x + 1.5) / (250.0 * (i/j))$
- $x + 1.5 / 250.0 * i / j$
- $-x * -y * (i + j) / k$
- $(i / 5) * y$
- `Math.min(i, Math.min(j,k))`
- `Math.exp(3, 2)`
- $y \% x$
- `Math.pow(3, 2)`
- $(int)y \% k$
- $i / 5 * y$

2. Suppose we have the following declarations:

```
int m, n, i = 3, j = 4, k = 5;
float v, w, x = 34.5f, y = 12.25f;
```

Determine the value assigned to the variable in each of the following assignment statements, or explain why it is not a valid assignment.

- `w = Math.pow(3, Math.pow(i, j));`
- `v = x / i;`
- `w = Math.ceil(y) % k;`
- `n = (int) x / y * i / 2;`
- `x = Math.sqrt(i*i - 4*j*k);`
- `m = n + i * j;`
- `n = k / (j * i) * x + y;`
- `i = i + 1;`
- `w = float(x + i);`
- `x = x / i / y / j;`

3. Suppose we have the following declarations:

```
int i, j;
float x, y;
double u, v;
```

Which of the following assignments are valid?

- `i = x;`
- `x = u + y;`
- `x = 23.4 + j * y;`
- `v = (int) x;`
- `y = j / i * x;`

4. Write Java expressions to compute each of the following.
 - a. The square root of $B^2 + 4AC$ (A and C are distinct variables)
 - b. The square root of $X + 4Y^3$
 - c. The cube root of the product of X and Y
 - d. The area πR^2 of a circle
5. Determine the output of the following program without running it.

```
class TestOutput {
    public static void main(String[] args) {

        System.out.println("One");
        System.out.print("Two");
        System.out.print("\n");

        System.out.print("Three");
        System.out.println("Four");
        System.out.print("\n");

        System.out.print("Five");
        System.out.println("Six");

    }
}
```

6. Determine the output of the following code.

```
int x, y;
x = 1;
y = 2;
System.out.println("The output is " + x + y );
System.out.println("The output is " + ( x + y ) );
```

Level 1 Programming Exercises ★

7. Write a program to convert centimeters (input) to feet and inches (output).
1 in = 2.54 cm.
8. Write a program that inputs temperature in degrees Celsius and prints out the temperature in degrees Fahrenheit. The formula to convert degrees Celsius to equivalent degrees Fahrenheit is

$$\text{Fahrenheit} = 1.8 \times \text{Celsius} + 32$$

9. Write a program that accepts a person's weight and displays the number of calories the person needs in one day. A person needs 19 calories per pound of body weight, so the formula expressed in Java is

```
calories = bodyWeight * 19;
```

(Note: We are not distinguishing between genders.)

10. Write a program that does the reverse of Exercise 9, that is, input degrees Fahrenheit and prints out the temperature in degrees Celsius. The formula to convert degrees Fahrenheit to equivalent degrees Celsius is

$$\text{Celsius} = \frac{5}{9} \times (\text{Fahrenheit} - 32)$$

11. Write a program that inputs the year a person is born and outputs the age of the person in the following format:

You were born in 1990 and will be (are) 18 this year.

12. A quantity known as the *body mass index* (BMI) is used to calculate the risk of weight-related health problems. BMI is computed by the formula

$$\text{BMI} = \frac{w}{(h/100.0)^2}$$

where w is weight in kilograms and h is height in centimeters. A BMI of about 20 to 25 is considered “normal.” Write an application that accepts weight and height (both integers) and outputs the BMI.

13. If you invest P dollars at R percent interest rate compounded annually, in N years, your investment will grow to

$$P(1 + R/100)^N$$

dollars. Write an application that accepts P , R , and N and computes the amount of money earned after N years.

14. The volume of a sphere is computed by the equation

$$V = \frac{4}{3}\pi r^3$$

where V is the volume and r is the radius of the sphere. Write a program that computes the volume of a sphere with a given radius r .

Level 2 Programming Exercises ★★

15. The velocity of a satellite circling around the Earth is computed by the formula

$$v = \sqrt{\frac{GM_E}{r}}$$

where $M_E = 5.98 \times 10^{24}$ kg is the mass of the Earth, r the distance from the center of the Earth to the satellite in meters, and $G = 6.67 \times 10^{-11}$ m³/kg · s² the universal gravitational constant. The unit of the velocity v is m/s. Write a program that inputs the radius r and outputs the satellite’s velocity. Confirm that a satellite that is closer to the Earth travels faster. Define symbolic constants for M_E and G . The distance to the Hubble Space Telescope from the center of the Earth, for example, is approximately 6.98×10^6 m.

16. Your weight is actually the amount of gravitational attraction exerted on you by the Earth. Since the Moon's gravity is only one-sixth of the Earth's gravity, on the Moon you would weigh only one-sixth of what you weigh on Earth. Write a program that inputs the user's Earth weight and outputs her or his weight on Mercury, Venus, Jupiter, and Saturn. Use the values in this table.

Planet	Multiply the Earth Weight by
Mercury	0.4
Venus	0.9
Jupiter	2.5
Saturn	1.1

17. When you say you are 18 years old, you are really saying that the Earth has circled the Sun 18 times. Since other planets take fewer or more days than Earth to travel around the Sun, your age would be different on other planets. You can compute how old you are on other planets by the formula

$$y = \frac{x \times 365}{d}$$

where x is the age on Earth, y is the age on planet Y , and d is the number of Earth days the planet Y takes to travel around the Sun. Write an application that inputs the user's Earth age and print outs his or her age on Mercury, Venus, Jupiter, and Saturn. The values for d are listed in the table.

Planet	$d =$ Approximate Number of Earth Days for This Planet to Travel around the Sun
Mercury	88
Venus	225
Jupiter	4,380
Saturn	10,767

18. Write a program to solve quadratic equations of the form

$$Ax^2 + Bx + C = 0$$

where the coefficients A , B , and C are real numbers. The two real number solutions are derived by the formula

$$x = \frac{-B \pm \sqrt{B^2 - 4AC}}{2A}$$

For this exercise, you may assume that $A \neq 0$ and the relationship

$$B^2 \geq 4AC$$

holds, so there will be real number solutions for x .

19. Write a program that determines the number of days in a given semester. Input to the program is the year, month, and day information of the first and the last days of a semester. *Hint:* Create `GregorianCalendar` objects for the start and end dates of a semester and manipulate their `DAY_OF_YEAR` data.
20. Modify the `Ch3FindDayOfWeek` program by accepting the date information as a single string instead of accepting the year, month, and day information separately. The input string must be in the `MM/dd/yyyy` format. For example, July 4, 1776, is entered as `07/04/1776`. There will be exactly two digits for the month and day and four digits for the year.
21. Leonardo Fibonacci of Pisa was one of the greatest mathematicians of the Middle Ages. He is perhaps most famous for the Fibonacci sequence, which can be applied to many diverse problems. One amusing application of the Fibonacci sequence is in finding the growth rate of rabbits. Suppose a pair of rabbits matures in 2 months and is capable of reproducing another pair every month after maturity. If every new pair has the same capability, how many pairs will there be after 1 year? (We assume here that no pairs die.) The table below shows the sequence for the first 7 months. Notice that at the end of the second month, the first pair matures and bears its first offspring in the third month, making the total two pairs.

<u>Month No.</u>	<u>Number of Pairs</u>
1	1
2	1
3	2
4	3
5	5
6	8
7	13

The N th Fibonacci number in the sequence can be evaluated with the formula

$$F_N = \frac{1}{\sqrt{5}} \left[\left(\frac{1 + \sqrt{5}}{2} \right)^N - \left(\frac{1 - \sqrt{5}}{2} \right)^N \right]$$

Write an application that accepts N and displays F_N . Note that the result of computation using the `Math` class is `double`. You need to display it as an integer.

22. According to Newton's universal law of gravitation, the force F between two bodies with masses M_1 and M_2 is computed as

$$F = k \left(\frac{M_1 M_2}{d^2} \right)$$

where d is the distance between the two bodies and k is a positive real number called the *gravitational constant*. The gravitational constant k is

approximately equal to $6.67E-8 \text{ dyn} \cdot \text{cm}^2/\text{g}^2$. Write an application that (1) accepts the mass for two bodies in grams and the distance between the two bodies in centimeters and (2) computes the force F . Use the standard input and output, and format the output appropriately. For your information, the force between the Earth and the Moon is $1.984E25 \text{ dyn}$. The mass of the earth is $5.983E27 \text{ g}$, the mass of the moon is $7.347E25 \text{ g}$, and the distance between the two is $3.844E10 \text{ cm}$.

23. Dr. Caffeine's Law of Program Readability states that the degree of program readability R (whose unit is *mocha*) is determined as

$$R = k \cdot \frac{CT^2}{V^3}$$

where k is Ms. Latte's constant, C is the number of lines in the program that contain comments, T is the time spent (in minutes) by the programmer developing the program, and V is the number of lines in the program that contain nondescriptive variable names. Write an application to compute the program readability R . Ms. Latte's constant is $2.5E2 \text{ mocha lines}^2/\text{min}^2$. (*Note*: This is just for fun. Develop your own law, using various functions from the Math class.)

Level 3 Programming Exercises ★★

24. Write a program that accepts the unit weight of a bag of coffee in pounds and the number of bags sold and displays the total price of the sale, computed as

```
totalPrice          = unitWeight * numberOfUnits * 5.99;
totalPriceWithTax = totalPrice + totalPrice * 0.0725;
```

where 5.99 is the cost per pound and 0.0725 is the sales tax. Display the result in the following manner:

Number of bags sold:	32
Weight per bag:	5 lb
Price per pound:	\$5.99
Sales tax:	7.25%
Total price:	\$ 1027.884

Draw the program diagram.

25. If the population of a country grows according to the formula

$$y = ce^{kx}$$

where y is the population after x years from the reference year, then we can determine the population of a country for a given year from two census figures. For example, given that a country with a population of 1,000,000 in 1970 grows to 2,000,000 by 1990, we can predict the country's population in the year 2000. Here's how we do the computation. Letting x be the number of years after 1970, we obtain the constant c as 1,000,000 because

$$1,000,000 = ce^{k0} = c$$

Then we determine the value of k as

$$y = 1,000,000e^{kx}$$

$$\frac{2,000,000}{1,000,000} = e^{20k}$$

$$k = \frac{1}{20} \ln \frac{2,000,000}{1,000,000} \approx 0.03466$$

Finally we can predict the population in the year 2000 by substituting 0.03466 for k and 30 for x (2000 – 1970 = 30). Thus, we predict

$$y = 1,000,000e^{0.03466(30)} \approx 2,828,651$$

as the population of the country for the year 2000. Write an application that accepts five input values—year A, population in year A, year B, population in year B, and year C—and predict the population for year C.

26. In Section 3.9, we use the formula

$$\text{MR} = \frac{\text{AR}}{12}$$

to derive the monthly interest rate from a given annual interest rate, where MR is the monthly interest rate and AR is the annual interest rate (expressed in a fractional value such as 0.083). This annual interest rate AR is called the *stated annual interest rate* to distinguish it from the *effective annual interest rate*, which is the true cost of a loan. If the stated annual interest rate is 9 percent, for example, then the effective annual interest rate is actually 9.38 percent. Naturally, the rate that the financial institutions advertise more prominently is the stated interest rate. The loan calculator program in Section 3.9 treats the annual interest rate that the user enters as the stated annual interest rate. If the input is the effective annual interest rate, then we compute the monthly rate as

$$\text{MR} = (1 + \text{EAR})^{1/12} - 1$$

where EAR is the effective annual interest rate. The difference between the stated and effective annual interest rates is negligible only when the loan amount is small or the loan period is short. Modify the loan calculator program so that the interest rate that the user enters is treated as the effective annual interest rate. Run the original and modified loan calculator programs, and compare the differences in the monthly and total payments. Use loan amounts of 1, 10, and 50 million dollars with loan periods of 10, 20, and 30 years and annual interest rates of 0.07, 0.10, and 0.18 percent, respectively. Try other combinations also.

Visit several websites that provide a loan calculator for computing a monthly mortgage payment (one such site is the financial page at **www.cnn.com**). Compare your results to the values computed by the websites you visited. Determine whether the websites treat the input annual interest rate as stated or effective.

27. Ask the user to enter his or her birthday in the MM/DD/YYYY format and output the number of days between the birthday and today. This gives the person's age in days.

Development Exercises

For the following exercises, use the incremental development methodology to implement the program. For each exercise, identify the program tasks, create a design document with class descriptions, and draw the program diagram. Map out the development steps at the start. State any assumptions you must make about the input. Present any design alternatives and justify your selection. Be sure to perform adequate testing at the end of each development step.

28. Develop an application that reads a purchase price and an amount tendered and then displays the change in dollars, quarters, dimes, nickels, and pennies. Two input values are entered in cents, for example, 3480 for \$34.80 and 70 for \$0.70. Display the output in the following format:

```
Purchase Price:  $ 34.80
Amount Tendered: $ 40.00

Your change is:  $ 5.20

                    5 one-dollar bill(s)
                    0 quarter(s)
                    2 dime(s)
                    0 nickel(s)
                    0 penn(y/ies)

Thank you for your business. Come back soon.
```

Notice the input values are to be entered in cents (int data type), but the echo printed values must be displayed with decimal points (float data type).

29. MyJava Coffee Outlet runs a catalog business. It sells only one type of coffee beans, harvested exclusively in the remote area of Irian Jaya. The company sells the coffee in 2-lb bags only, and the price of a single 2-lb bag is \$5.50. When a customer places an order, the company ships the order in boxes. The boxes come in three sizes: the large box holds 20 bags of 2 lb, the medium 10 bags, and the small 5 bags. The cost of a large

box is \$1.80; a medium box, \$1.00; and a small box, \$0.60. The order is shipped in the least expensive manner. For example, the order of 52 bags will be shipped in four boxes: two large, one medium, and one small. The rule for packing is to fill the large and medium boxes completely; that is, the box is fully packed. Only the small boxes can have empty spaces. For example, to ship 52 bags, you could have used 3 large boxes, but that would leave the third box not fully packed. Develop a program that computes the total cost of an order. Display the output in the following format:

```

Number of Bags Ordered: 52 - $ 286.00

Boxes Used:
    2 Large - $3.60
    1 Medium - $1.00
    1 Small - $0.60

Your total cost is: $ 291.20

```

30. Repeat Exercise 29, but this time, accept the date when the order is placed and display the expected date of arrival. The expected date of arrival is two weeks (14 days) from the date of order. The order date is entered as a single string in the MM/dd/yyyy format. For example, November 1, 2008 is entered as 11/01/2008. There will be exactly two digits each for the month and day and four digits for the year. Display the output in the following format:

```

Number of Bags Ordered: 52 - $ 286.00

Boxes Used:
    2 Large - $3.60
    1 Medium - $1.00
    1 Small - $0.60

Your total cost is: $ 291.20

Date of Order:           November 1, 2008
Expected Date of Arrival: November 15, 2008

```

31. Using a Turtle object from the galapagos package, draw three rectangles. Accept the width and the length of the smallest rectangle from the user. The middle and the largest rectangles are 40 and 80 percent larger, respectively, than the smallest rectangle. The galapagos package and its documentation are available at the McGraw-Hill book website.

32. Develop a program that draws a bar chart using a Turtle object. Input five int values, and draw the vertical bars that represent the entered values in the following manner:

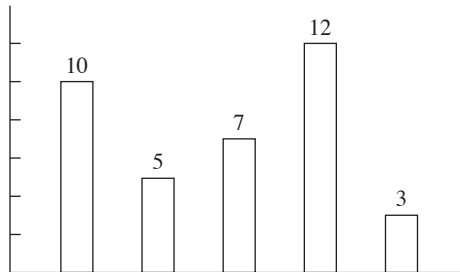

Your Turtle must draw everything shown in the diagram, including the axes and numbers.

Defining Your Own Classes—Part 1

4

O b j e c t i v e s

After you have read and studied this chapter, you should be able to

- Define a class with multiple methods and data members.
- Differentiate the local and instance variables.
- Define and use value-returning methods.
- Distinguish private and public methods.
- Distinguish private and public data members.
- Pass both primitive data and objects to a method.

Introduction



S

o far we have been using only standard classes such as `System`, `String`, and others when we wrote programs. For a basic program, that is fine. However, we need to learn how to write programs using our own classes (in addition to using the standard classes) when the programs become large and complex. In this chapter, we learn the basics of how to define our own classes. And, in Chapter 7, we will cover more advanced topics on defining classes.

4.1 First Example: Defining and Using a Class

The most economical and effective means of on-campus transportation is without doubt a bicycle. Suppose we want to develop a program that tracks the bicycles by assigning to them some form of identification number along with the relevant information, such as the owner's name and phone number. To develop such a Java program, we need to design many different types of objects. For example, we need objects to handle input, output, data storage, and other computational tasks. Among the many types of objects necessary for this program, we will design one class here that models a bicycle. There's no such `Bicycle` class among the standard classes, of course, so we need to define one ourselves. We will learn how to define the `Bicycle` class in this section. We will start with a very simplistic `Bicycle` class. Using this class, we can only assign and retrieve the owner's name. Before we look inside the `Bicycle` class and explain how the class is defined, let's first look at how we might use it in our program. The following sample program creates two `Bicycle` objects, assigns the owners' names to them, and displays the information:

```
class BicycleRegistration {
    public static void main(String[] args) {
        Bicycle bike1, bike2;
        String owner1, owner2;

        bike1 = new Bicycle( ); //Create and assign values to bike1
        bike1.setOwnerName("Adam Smith");

        bike2 = new Bicycle( ); //Create and assign values to bike2
        bike2.setOwnerName("Ben Jones");

        //Output the information
        owner1 = bike1.getOwnerName( );
        owner2 = bike2.getOwnerName( );

        System.out.println(owner1 + " owns a bicycle.");
        System.out.println(owner2 + " also owns a bicycle.");
    }
}
```

programmer-
defined classes

Here's the definition of the `Bicycle` class. To distinguish it from the standard classes, we call the `Bicycle` and other classes we define *programmer-defined classes*.

```
class Bicycle {
    // Data Member
    private String ownerName;
    //Constructor: Initializes the data member
    public Bicycle( ) {
        ownerName = "Unknown";
    }
    //Returns the name of this bicycle's owner
    public String getOwnerName( ) {
        return ownerName;
    }
    //Assigns the name of this bicycle's owner
    public void setOwnerName(String name) {
        ownerName = name;
    }
}
```

The dependency diagram between the two classes is as follows:



When this program is executed, we get the following output on the standard output window:

```
Adam Smith owns a bicycle.
Ben Jones also owns a bicycle.
```

This main class should look very familiar to all of us. The key difference lies in the use of the `Bicycle` class instead of the standard classes we have been using so far. The way we use the `Bicycle` class is the same. For example, we create a `Bicycle` object `bike2` by calling the new operator, and we assign the name of its owner by executing

```
bike2 = new Bicycle( );
bike2.setOwnerName("Ben Jones");
```

To get the name of the owner of `bike2`, we write

```
bike2.getOwnerName()
```

And we can assign the returned value to a variable if we write

```
String owner2;
...
owner2 = bike2.getOwnerName();
```

Although it is not a requirement, we will save one class definition per file to keep things simple. For the file name, we will use the name of the class followed by the `java` suffix. So, we save the `Bicycle` class in a file named `Bicycle.java`.

Things to Remember



Save one class definition per file. Use the name of the class followed by the suffix `java` as the file name. Follow this rule to avoid any unnecessary complications.

For this sample program, we have created two classes—`BicycleRegistration` (the main class) and `Bicycle`. So there are two source files for this program.



`BicycleRegistration.java`



`Bicycle.java`

The Bicycle Class

Now let's study the `Bicycle` class. Table 4.1 lists the three methods of the `Bicycle` class and their description.

Here's a template for the `Bicycle` class declaration:

```
class Bicycle {
    //data members
    //methods
}
```

Table 4.1 The three methods of the `Bicycle` class. The first method is called a constructor

Method	Parameter	Description
<code>Bicycle</code>	None	Initializes the owner's name to <code>Unassigned</code> .
<code>getOwnerName</code>	None	Returns the owner's name.
<code>setOwnerName</code>	Name of the owner (string)	Assigns the bicycle owner's name to the passed value.

The class declaration begins with the reserved word `class` followed by the name. Any valid identifier that is not a reserved word can be used as the class name.

We define the three methods inside the class declaration. But before we can provide the method definitions, we need to consider the data members of the `Bicycle` class. Remember, in Section 1.3, we stated that data members of a class are the data values associated with the class or instances of the class, such as the current balance of an `Account` object. What would be the data members of `Bicycle` objects? We need to know the owner's name of every `Bicycle` object, so we'll define one data member to store the owner's name. The data members of a class are declared within the class declaration. Here's how we define the data member `ownerName` of the `Bicycle` class:

```
class Bicycle {
    private String ownerName;
    //definitions for the constructor,
    //getOwnerName, and setOwnerName methods come here
}
```

The `ownerName` data member is an instance variable (we will learn how to declare class constants later in this chapter and class variables in Chap. 7). Remember that, in Section 1.3, we defined an instance variable as the data member we associate to an individual instance and whose value can change over time. In other words, each instance of the class will have its own copy. After the two `Bicycle` objects are created and assigned their respective names by program, we have the following memory state:

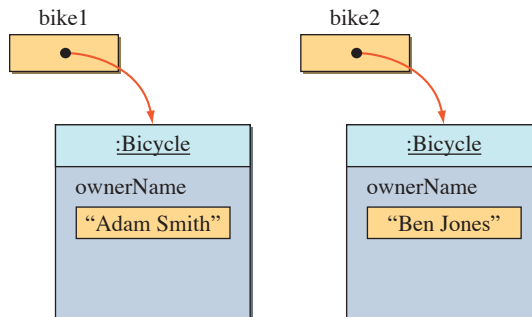

The syntax for the data member declaration is

```
<modifier-list> <data type> <name> ;
```

where `<modifier-list>` designates different characteristics of the data member, `<data type>` the class name or primitive data type, and `<name>` the name of the data member. Here's how the general syntax corresponds to the actual declaration:

```

Modifier |
├──
└──
private

Data Type
├──
└──
String

Name
├──
└──
ownerName ;

```

accessibility
modifier

In this example, the data member has one modifier named `private`. This modifier is called an *accessibility modifier*, or a *visibility modifier*, and it restricts who can have a direct access to the data member. If the modifier is `private`, then only the methods defined in the class can access it directly. We will provide a more detailed discussion of the accessibility modifiers in Section 4.6. For now, it suffices to remember that data members are declared `private` for the most part.

Now that the necessary data member is taken care of, we are ready to define the three methods. We start with the `setOwnerName` method, which is declared as

```
public void setOwnerName(String name) {
    ownerName = name;
}
```

The syntax for defining a method, as given in Chapter 2, is

```
<modifiers> <return type> <method name> ( <parameters> ) {
    <statements>
}
```

The following diagram shows how the components in the general syntax correspond to the actual elements in the `setOwnerName` method:

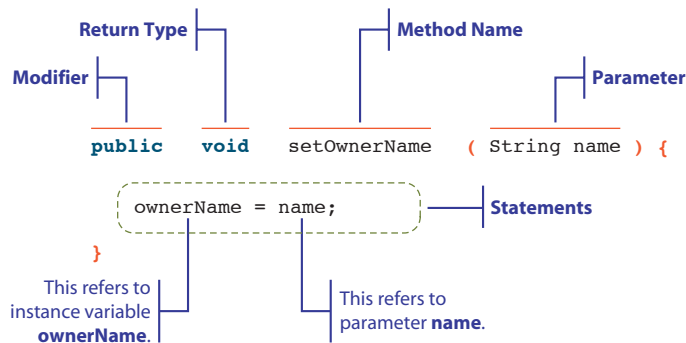

We explained in Chapter 1 that methods may or may not return a value. A method that does not return a value, such as this `setOwnerName` method, is declared as `void`. It is called a *void method*. The accessibility modifier for the `setOwnerName` method is declared as `public`. This means the program that uses the `Bicycle` class can access, or call, this method. It is possible (and could be useful) to declare a method as `private`. If a method is declared as `private`, then it cannot be called from the program that uses the class. It can only be called from the other methods of the same class. For now we will limit our discussion to public methods. Here we declare all methods as `public` because we want the programs that use the `Bicycle` class to be able to call them. We will go over the use of private methods later in the chapter.

void method

The `getOwnerName` method is defined as follows:

```
public String getOwnerName( ) {
    return ownerName;
}
```

The following diagram shows how the components in the general syntax correspond to the actual elements in the `getOwnerName` method:

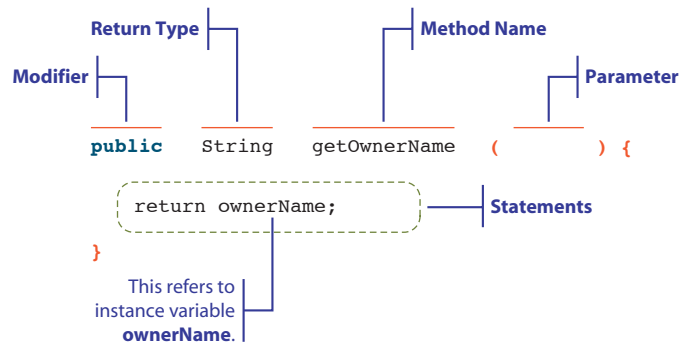

value-returning
method

This is a *value-returning method*. When this method is called, it returns a value to the caller. The `getOwnerName` method returns a string value—the value of instance variable `ownerName`—so its return type is declared as `String`. A value-returning method must include a return statement of the format

return state-
ment syntax

```
return <expression> ;
```

The data type of `<expression>` must be compatible with the declared return type of the method. For example, if the return type is `int`, then the data type of the returned value must be compatible with `int` (data types `int`, `short`, and `byte` are all compatible with `int`). Data type compatibilities are explained in Section 3.2.

If a method returns a value, then we can include a call to the method in an expression itself. For example, instead of writing

```
Bicycle bike;
...

String owner = bike.getOwnerName( );
System.out.println(owner + "owns a bike.");
```

we can write

```
Bicycle bike;
...

System.out.println(bike.getOwnerName( ) + "owns a bike.");
```

accessor

mutator

A method that returns information about an object (such as who is the owner of a bicycle) is called an *accessor*. The `getOwnerName` method is an accessor. An inverse of an accessor that sets a property of an object is called a *mutator*. The `setOwnerName` method is a mutator. Accessors and mutators are commonly called *get* and *set methods*, respectively.

A value-returning method can include more than one return statement. The use of multiple return statements make sense only in the context of the control statements, which we will discuss in Chapters 5 and 6. We will be seeing examples of multiple return statements in these chapters.

constructor

The first method defined in the `Bicycle` class is a special method called a constructor. A *constructor* is a special method that is executed when a new instance of the class is created, that is, when the `new` operator is called. Here's the constructor for the `Bicycle` class:

```
public Bicycle( ) {
    ownerName = "Unassigned";
}
```

It follows the general syntax

```
public <class name> ( <parameters> ) {
    <statements>
}
```

where `<class name>` is the name of the class to which this constructor belongs. The following diagram shows how the components in the general syntax correspond to the actual elements in the constructor of the `Bicycle` class:

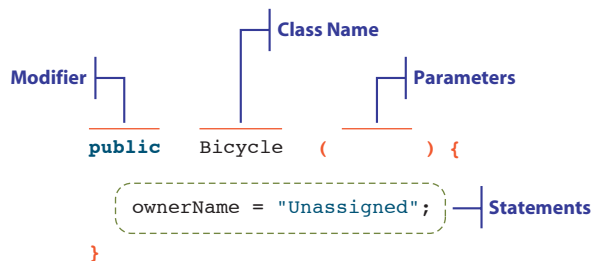

Notice that a constructor does not have a return type and, consequently, will never include a return statement. The modifier of a constructor does not have to be `public`, but non-`public` constructors are rarely used. This example shows no parameters, but it is very common to define a constructor with two or three parameters. We will see an example of a constructor that accepts two parameters in Section 4.5. Until then, we will define only a zero-parameter constructor.

The purpose of the `Bicycle` constructor is to initialize the data member to a value that reflects the state to which the real name is not yet assigned. Since a constructor is executed when a new instance is created, it is the most logical place

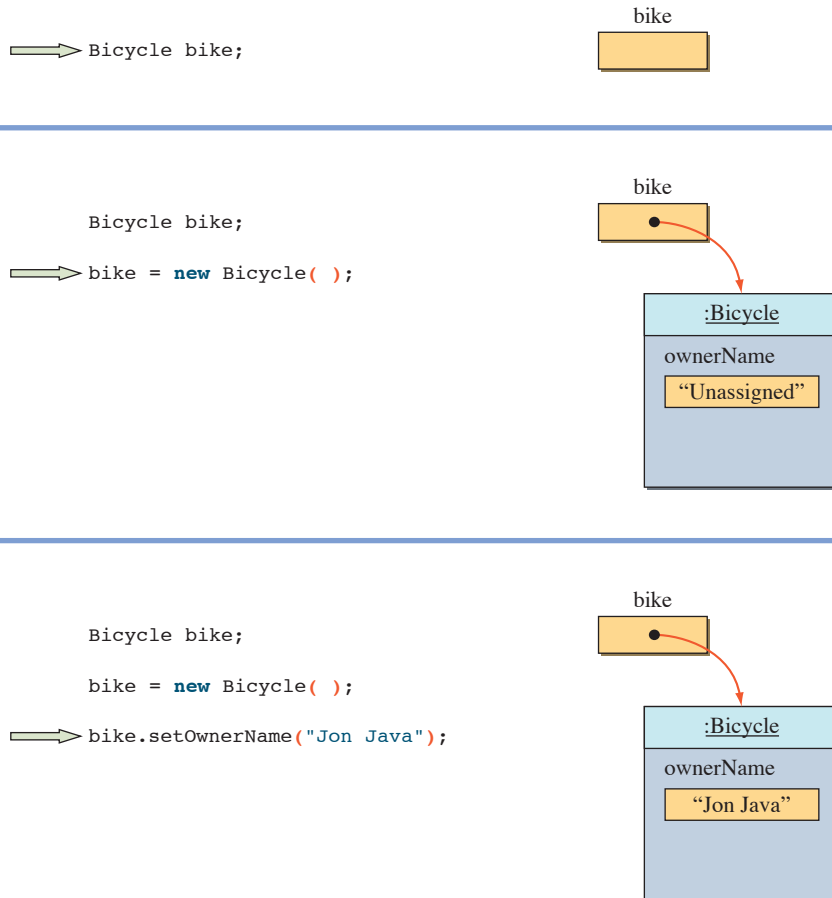

Figure 4.1 A sequence of state-of-memory diagrams that illustrate the effects of executing the constructor and the `setOwnerName` method of the `Bicycle` class.

to initialize the data members and perform any other initialization tasks. Figure 4.1 shows a sequence of state-of-memory diagrams illustrating the effects of executing the constructor and the `setOwnerName` method of the `Bicycle` class.

We stated earlier that the `Bicycle` class has three methods, of which one is a constructor. However, a constructor is distinct from other “regular” methods, so it is more common to state that the `Bicycle` class has one constructor and two methods.

Things to Remember



Instead of saying “a class has three methods including one constructor,” it is more common to say “a class has one constructor and two methods.” We will use the later expression in this book.

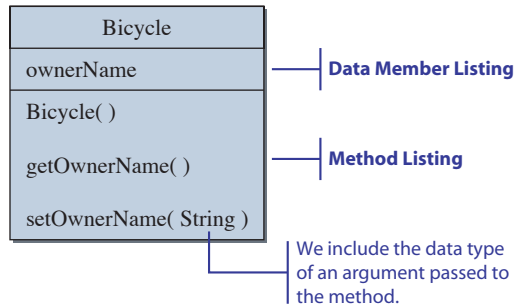

Figure 4.2 A class diagram of the **Bicycle** class with two methods and one data member.

We will provide a more detailed discussion on constructors in Section 4.5.

The class diagram that lists the data member, the constructor, and two methods of the **Bicycle** class is shown in Figure 4.2.

In listing the data members and methods of a class, we will use the following convention:

class listing
convention

```
class <class name> {
    // data members
    // constructor
    // methods
}
```

We list the data members first, then the constructor, and finally the methods. Within each group, we list elements in alphabetical order. Keep in mind that this convention for grouping elements and ordering them within a group is for our convenience. The Java compiler does not care how we list the data members and methods.

Things to Remember



The Java compiler does not care how we order the methods and data members in the class declaration. We adopt the listing convention to make the class declaration easier for us to follow.

Compiling and Running BicycleRegistration

Up until now, when we ran the sample programs, we simply compiled and executed the main class. That's all we need to do because the main class is the only class we

created for the sample programs. But for this sample program, we have created two classes—`BicycleRegistration` (the main class) and `Bicycle`. So there are two source files for this program.

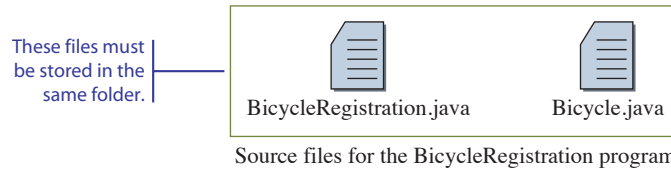

From now on, we will use the name of the main class to refer the whole program. To run the `BicycleRegistration` program, we must first compile the two source files and then run the main class. Here are the steps we follow to run this sample program (we will illustrate the steps using the minimalist approach, see App. A):

1. Compile the `Bicycle` class.

```
javac Bicycle.java
```

2. Compile the `BicycleRegistration` class.

```
javac BicycleRegistration.java
```

3. Run the `BicycleRegistration` class.

```
java BicycleRegistration
```

There is one last thing to remember. The way the classes are written now, the easiest way to manage a program that includes multiple programmer-defined classes is to save the source files in the same folder (directory). We will learn how to organize classes into a package in Chapter 7 so we can manage the organization of classes in a more effective manner. Until then, just remember to place all sources files for a program in the same folder. If you don't do this, the Java compiler and interpreter may not be able to compile and run the program.

Things to Remember



Place all source files for a program in the same folder (directory).

It is not necessary to create a separate folder for each program, though. In other words, one folder can contain source files for multiple programs. For example,

we could create one folder to place all source files for this chapter's sample code. However, we recommend that students create a separate folder for each programming assignment or lab project for easy management.

You
Might
Want to
Know



The class declaration can be preceded with the accessibility modifier **public** or **private**. For now, we do not use any accessibility modifier for the class declaration. We will discuss the issue when we discuss a package organization in Chapter 7.

Quick
CHECK
✓

1. Extend the Bicycle class by adding the second data member `tagNo` of type `String`. Declare this data member as `private`.
2. Add a new method to the Bicycle class that assigns a tag number. This method will be called as follows:

```
Bicycle bike;
bike = new Bicycle( );
...
bike.setTagNo("2004-134R");
```

3. Add a another method to the Bicycle class that returns the bicycle's tag number. This method will be called as follows:

```
Bicycle bike;
bike = new Bicycle( );
...
String tag = bike.getTagNo( );
```

4.2 | Second Example: Defining and Using Multiple Classes

Let's write a second sample program to get more practice in defining classes. In this example, we will define a new class named `Account`. An `Account` object has the name of the owner (`String`) and the balance (`double`). We have two methods—`add` and `deduct`—to deposit to and withdraw money from the account. There are methods to set the initial balance and retrieve the current balance. These two methods are named `setInitialBalance` and `getCurrentBalance`. Finally, we have an accessor and mutator for the account owner's name—`getOwnerName` and `setOwnerName`.

The second sample program uses the `Bicycle` class from Section 4.1 and the `Account` class we define shortly in this section. Here's the second sample program:

```
class SecondMain {
    //This sample program uses both the Bicycle and Account classes

    public static void main(String[] args) {

        Bicycle bike;
        Account acct;

        String myName = "Jon Java";

        bike = new Bicycle( );
        bike.setOwnerName(myName);

        acct = new Account( );
        acct.setOwnerName(myName);
        acct.setInitialBalance(250.00);

        acct.add(25.00);
        acct.deduct(50);

        //Output some information
        System.out.println(bike.getOwnerName() + " owns a bicycle and");
        System.out.println("has $ " + acct.getCurrentBalance() +
            " left in the bank");
    }
}
```

This program creates one `Bicycle` object and one `Account` object, sets their owner name to Jon Java, initializes the account balance to \$250.00, adds \$25.00 to the account, deducts \$50.00 from the account, and finally prints out some information of bike and acct objects. The program diagram is as follows:

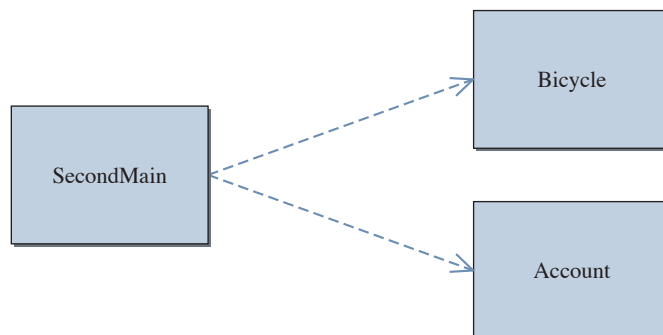

We are using the `Bicycle` class from Section 4.1 without modification, so we only have to consider defining the `Account` class. There are two data members for the class, one to store the owner's name and another to maintain the account balance. We have the following declaration for the two data members:

```
class Account {
    private String ownerName;
    private double balance;
    //constructor and method declarations come here
}
```

The set and get methods for the owner's name are identical to those defined for the `Bicycle` class. The add and deduct methods modify the balance by adding or deducting the passed amount. They are defined as follows:

```
public void add(double amt) {
    balance = balance + amt;
}
public void deduct(double amt) {
    balance = balance - amt;
}
```

The `setInitialBalance` and `getCurrentBalance` methods are similarly defined as the other set and get methods. Here's the complete definition of the `Account` class:

```
class Account {
    // Data Members
    private String ownerName;
    private double balance;
    //Constructor
    public Account( ) {
        ownerName = "Unassigned";
        balance = 0.0;
    }
    //Adds the passed amount to the balance
    public void add(double amt) {
        balance = balance + amt;
    }
    //Deducts the passed amount from the balance
    public void deduct(double amt) {
        balance = balance - amt;
    }
}
```

```

//Returns the current balance of this account
public double getCurrentBalance( ) {
    return balance;
}

//Returns the name of this account's owner
public String getOwnerName( ) {

    return ownerName;
}

//Sets the initial balance of this account
public void setInitialBalance(double bal) {
    balance = bal;
}

//Assigns the name of this account's owner
public void setOwnerName(String name) {

    ownerName = name;
}
}

```

Figure 4.3 shows a class diagram of the Account class.

The second sample program is composed of three classes (we are not counting the standard classes).

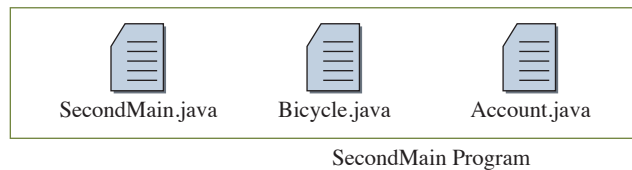

We need to compile the three classes before we can run the program. However, we do not have to compile all three classes every time we want to run the program. For example, if the Bicycle class is already compiled and we are not making any changes to it, then there's no need to compile the class again. (*Note:* We are assuming here that both programs are placed in the same directory. If the second program is in a separate folder, then you need to copy the bytecode file Bicycle.class to this folder.)

Notice the second call to the deduct method from the main method of SecondMain, which is

```
acct.deduct(10);
```

but the parameter for the deduct method is declared as type double. This call is valid because we are passing a value that is assignment-compatible to the double data type. We will elaborate on this topic in Section 4.3.

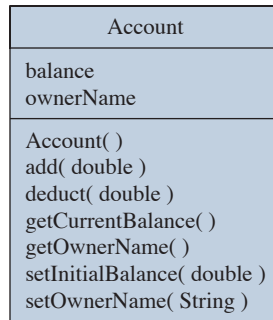

Figure 4.3 A class diagram of the **Account** class with two data members, one constructor, and six methods.



1. What is the output from the following code fragment?

```
Account acct;
acct = new Account ( );
acct.setInitialBalance(250);
acct.add(20);

System.out.println("Balance: "
    + acct.getCurrentBalance());
```

2. Write a code fragment to declare and create two `Account` objects named `acct1` and `acct2`. Initialize the balance to \$300 and \$500, respectively. Set the name of owner for both accounts to John Doe.

4.3 Matching Arguments and Parameters

Consider the following sample class that includes a method named `compute`. This method has three parameters—two `int` and one `double`.

```
class Demo {
    ...

    public void compute(int i, int j, double x) {

        //method body
        //the actual statements in the body
        //are irrelevant to the discussion

    }

    ...
}
```

When we call the compute method, we must pass three values. The values we pass must be assignment-compatible with the corresponding parameters. For example, it is not okay to pass a double value to an int parameter. Here are some valid calls from the main method:

```
class MyMain {
    public static void main(String[] arg) {
        Demo demo = new Demo();

        int i, k, m;

        i = 12;
        k = 10;
        m = 14;

        demo.compute(3, 4, 5.5);
        demo.compute(i, k, m);
        demo.compute(m, 20, 40);
    }
}
```

In the statement

```
demo.compute(m, 20, 40);
```

argument

parameter

the values `m`, `20`, and `40` are called arguments. An *argument* is a value we pass to a method, and the value is assigned to the corresponding parameters. A *parameter* is a placeholder in the called method to hold the value of a passed argument. The arguments and parameters are matched in left-to-right order. As long as the data type of an argument is assignment-compatible to the corresponding parameter, the call is valid.

The identifier we use for an argument has no relation to the identifier used for the corresponding parameter. In the statement

```
demo.compute(i, k, m);
```

the fact that the same identifier `i` is used for both the first parameter and the first argument has no significance. They are two distinct and separate variables, as shown in Figure 4.4. The figure also shows how the matching is done.

Things to Remember



A parameter receives the value of a corresponding argument. Because a parameter is like a placeholder that will not hold a value until an argument is passed to it, a parameter is called a formal parameter and an argument an actual parameter.

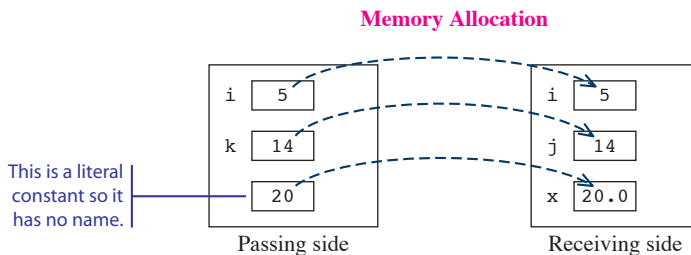
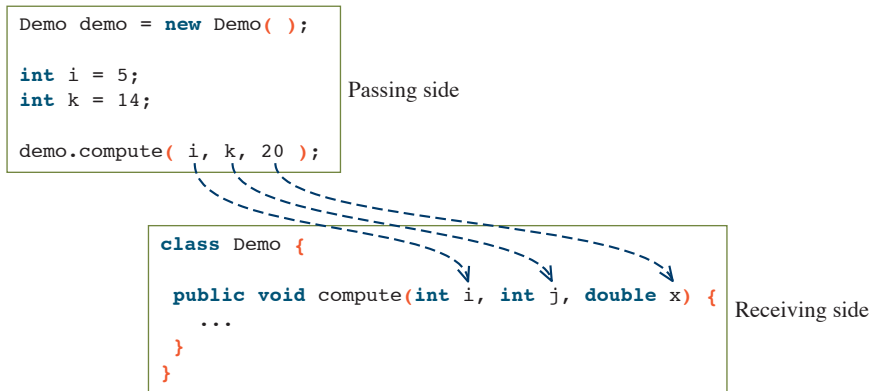

Figure 4.4 This diagram illustrates how the argument values are assigned, or passed, to the matching parameters.

4.4 Passing Objects to a Method

When calling the methods of the `Bicycle` and `Account` classes, we passed a numerical value or a `String`. In this section, we study how to pass an object when calling a method. Since a `String` is an object, in a sense, we actually know to pass an object as an argument to a method. However, a `String` is treated much as a primitive datum for the most part, so we will cover this topic using instances of our own class.

First, we define the `Student` class. A `Student` object has a name (`String`) and an email (`String`). Here's the definition:

```

class Student {

//Data Members
private String name;

private String email;
}

```

```

//Constructor
public Student( ) {
    name = "Unassigned";
    email = "Unassigned";
}

//Returns the email of this student
public String getEmail( ) {

    return email;
}

//Returns the name of this student
public String getName( ) {

    return name;
}

//Assigns the email of this student
public void setEmail(String address) {

    email = address;
}

//Assigns the name of this student
public void setName(String studentName) {

    name = studentName;
}
}

```

Student
name email
Student() getEmail() getName() setEmail(String) setName(String)

Then we define the LibraryCard class. A LibraryCard object is owned by a Student, and it records the number of books being checked out. Here's the definition:

```

class LibraryCard {

    // Data Members

    //student owner of this card
    private Student owner;

    //number of books borrowed
    private int borrowCnt;

    //Constructor
    public LibraryCard( ) {
        owner = null;
        borrowCnt = 0;
    }
}

```

LibraryCard
owner borrowCnt
LibraryCard() checkOut(int) getNumberOfBooks() getOwnerName() setOwner(Student) toString()

```

//numOfBooks are checked out
public void checkOut(int numOfBooks) {
    borrowCnt = borrowCnt + numOfBooks;
}

//Returns the number of books borrowed
public int getNumberOfBooks() {
    return borrowCnt;
}

//Returns the name of the owner of this card
public String getOwnerName() {
    return owner.getName();
}

//Sets owner of this card to student
public void setOwner(Student student) {
    owner = student;
}

//Returns the string representation of this card
public String toString() {
    return "Owner Name: " + owner.getName() + "\n" +
           "      Email: " + owner.getEmail() + "\n" +
           "Books Borrowed: " + borrowCnt;
}
}

```

Notice that we initialize the data member `owner` to null in the constructor. The value of null means that `owner` is pointing to no object. The `setOwner` method must be called to assign a `Student` object. The method accepts a `Student` object as its parameter and sets the data member `owner` to this `Student` object.

The `getOwnerName` method returns the name of the owner. It is defined as

```

public String getOwnerName() {
    return owner.getName();
}

```

Because the data member `owner` refers to a `Student` object, we can get the name of this student by calling its `getName` method.

The `toString` method is a method that returns a string representation of an object. Because an object can have a nested structure (e.g., an object's data member points to an instance of another class, the data members of this instance point to instances of other classes, and so forth), it is convenient for those who use the class to have a quick way to get printable information of an instance. Without such a `toString` method, the programmer who uses the class must write a code to fetch the

values of the data members individually. This can be quite tedious. With the `toString` method, she can display information of an instance by calling just one method `toString`.

The power of being able to pass an object to a method comes in handy when we want multiple objects to share the same object. For example, suppose a single student owns two library cards (say, one for the general library and another for the engineering library). Then we can make the data member `owner` of two `LibraryCard` objects to refer to the same `Student` object. Here's one such program:

```
class Librarian {
    public static void main(String[] args) {
        Student student;
        LibraryCard card1, card2;

        student = new Student( );
        student.setName("Jon Java");
        student.setEmail("jj@javauniv.edu");

        card1 = new LibraryCard( );
        card1.setOwner(student);
        card1.checkOut(3);

        card2 = new LibraryCard( );
        card2.setOwner(student); //the same student is the owner
                                //of the second card, too

        System.out.println("Card1 Info:");
        System.out.println(card1.toString() + "\n");

        System.out.println("Card2 Info:");
        System.out.println(card2.toString() + "\n");
    }
}
```

In this program, we create one `Student` object. Then we create two `LibraryCard` objects. For each of these `LibraryCard` objects, we pass the same student when calling their `setOwner` methods:

```
card1.setOwner(student);
...
card2.setOwner(student);
```

After the `setOwner` method of `card2` is called in the main method, we have the state of memory as shown in Figure 4.5.

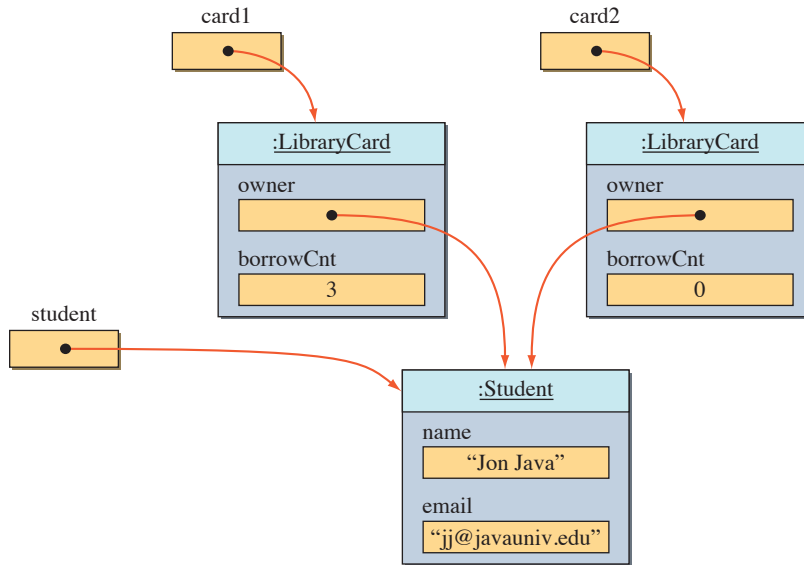

Figure 4.5 The state where the data members of two objects (of **LibraryCard**) are pointing to the same object (of **Student**).

It is critical to realize that when we say *pass an object to a method*, we are not sending a copy of an object, but rather a reference to the object. Figure 4.6 shows how the passing of an object is done.

Things to Remember



When we pass an object to a method, we are actually passing the address, or reference, of an object to the method.

You Might Want to Know



It is possible to return the *Student* object itself by defining the following method:

```
public Student getOwner( ) {
    return owner;
}
```

We will discuss such a method that returns an instance of a programmer-defined class in Chapter 7.

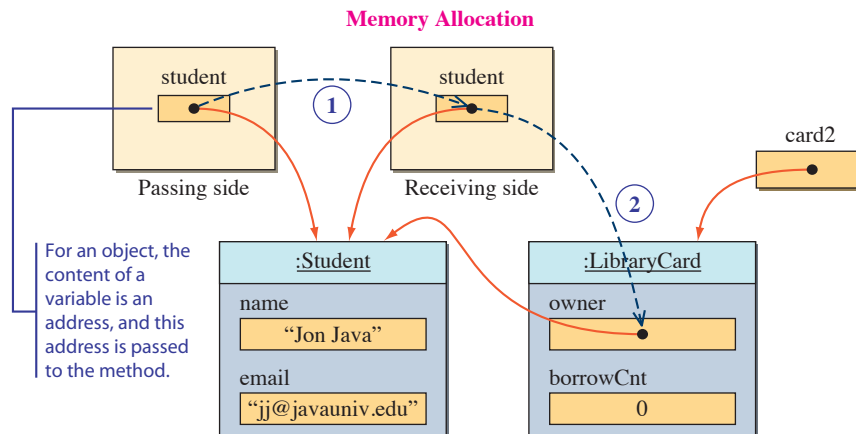
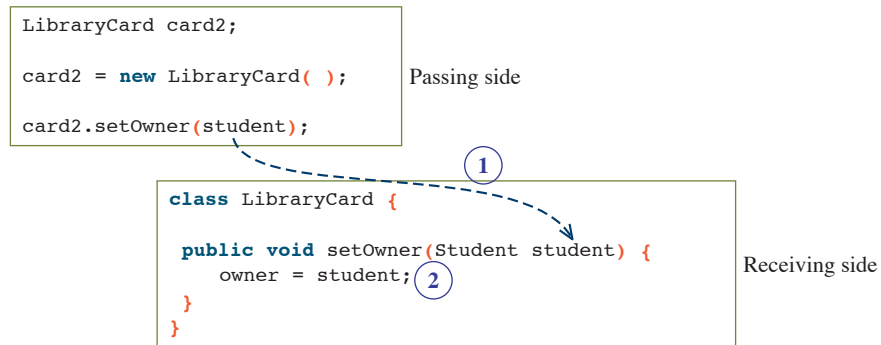

Figure 4.6 This diagram illustrates how an object is passed as an argument to a method.

4.5 Constructors

We provide more detailed coverage of the constructors in this section. The constructors we have defined so far accept no arguments. These constructors set the data members to some initial values. For example, the constructor for the `Bicycle` class in Section 4.1 initializes the value of `owner` (`String`) to `Unassigned`. For this particular `Bicycle` class, such a simplistic constructor is adequate. However, most cases require the constructors that accept one or more arguments. In fact, the way we defined the constructor for the `Account` class in Section 4.2 could lead to potential problems. In this section, we describe the use of constructors that accept one or more arguments, and we show how this solves the potential problems of the `Account` class.

Let's begin by reviewing the `Account` class from Section 4.2. We will identify some potential problems and present a new constructor as a solution to rectify them.

Consider the following code:

```
Account acct;
acct = new Account( );

acct.setInitialBalance(500);
acct.setInitialBalance(300);
```

What is the effect of such code? It is logically inconsistent to initialize the starting balance more than once. It should be called exactly one, but there is no such Java language feature that puts constraints on the number of times the `setInitialBalance` method can be called. The existence of this method is a problem, and we can remove it from the `Account` class by defining a constructor that sets the initial balance to a specified amount.

Now consider the following code:

```
Account acct;
acct = new Account( );

acct.add(200.00);
```

If an account can have the initial balance of zero, this code is acceptable. But if there is a rule that says, for example, an account must have the initial balance of \$25 or more, then the `setInitialBalance` method must be called first to initialize the balance to 25.00 or more before any transactions (add or deduct) take place. This problem can also be solved by the same constructor that sets the initial balance to a specified amount.

Here's a new constructor that eliminates the two problems in one stroke:

```
public Account(double startingBalance) {
    ownerName = "Unassigned";
    balance = startingBalance;
}
```

Once this constructor is defined, there is no longer a need for the `setInitialBalance` method, so we can safely remove it from the class definition. Only the `add` and `deduct` methods affect the balance after an object is created.

After the old constructor is replaced by this new constructor, we must create an instance by passing one argument when calling the new operator. For example, the code

```
Account acct;

acct = new Account(500.00);
```

will create a new `Account` object with its starting balance set to \$500. We can no longer create an instance by writing

```
Account acct;

acct = new Account( );
```

because there is no matching constructor anymore.

Instead of this one-parameter constructor, we can define a constructor that accepts the name of the owner also, so that it, too, can be initialized at the time of object creation. Here's how we define the two-parameter constructor:

```
public Account(String name, double startingBalance) {
    ownerName = name;
    balance = startingBalance;
}
```

This is the constructor we will include in the modified Account class. With this two-parameter constructor, here's how we create an Account object:

```
Account acct;
acct = new Account("John Smith", 500.00);
```

Notice that, even with this new constructor, we will keep the `setOwnerName` method in the class because we want to be able to change the name of the owner after the account is created.

From the three different constructors possible for the Account class, we have selected the two-parameter constructor to include in the class. Actually, it is possible to include all three constructors in the definition of the Account class. But until we learn how to define multiple constructors in Chapter 7, we will define exactly one constructor for our programmer-defined classes.

Hints, & Tips, Pitfalls



It is possible to define more than one constructor to a class. Multiple constructors are called *overloaded constructors*. It is almost always a good idea to define multiple constructors to a class. But to keep things simple, we will manage with one constructor per class until Chapter 7.

We are now ready to list the complete definition. Here's the second version of the Account class (for the actual class name we will use `AccountVer2` to avoid confusion when discussing different versions of the class definition):

```
class AccountVer2 {
    // Data Members
    private String ownerName;
    private double balance;
    //Constructor
    public AccountVer2(String name, double startingBalance) {
```

```

        ownerName = name;
        balance = startingBalance;
    }

    //Adds the passed amount to the balance
    public void add(double amt) {
        balance = balance + amt;
    }

    //Deducts the passed amount from the balance
    public void deduct(double amt) {
        balance = balance - amt;
    }

    //Returns the current balance of this account
    public double getCurrentBalance( ) {
        return balance;
    }

    //Returns the name of this account's owner
    public String getOwnerName( ) {

        return ownerName;
    }

    //Assigns the name of this account's owner
    public void setOwnerName(String name) {

        ownerName = name;
    }
}

```

Default Constructor

As a design guideline, we strongly recommend to include constructors to programmer-defined classes, as we have been doing from the beginning of the chapter. However, it is not a requirement to define a constructor explicitly in a class. If no constructor is defined for a class, then the Java compiler will automatically include a default constructor. A *default constructor* is a constructor that accepts no arguments and has no statements in its body. For example, if we omit a constructor from the Bicycle class, a default constructor

default
constructor

```

public Bicycle( ) {

}

```

will be added to the class by the compiler to ensure its instances can be created.

Even though a default constructor is automatically added by the compiler, we should never rely on it. We should always define our own constructor so that we can

initialize the data members properly and carry out any other initialization tasks. This ensures an object is created in a valid state (such as setting the balance of an account to more than the minimum).

Design Guidelines



Always define a constructor and initialize data members fully in the constructor so an object will be created in a valid state.

Once we define our own constructor, no default constructor is added. This means that once the constructor, such as

```
public Account(String name, double startingBalance ) {
    ownerName = name;
    balance = startingBalance;
}
```

is added to the Account class, we will no longer be able to create a Account object anymore by executing

```
Account acct;
acct = new Account( );
```

because no matching constructor can be found in the class.

Things to Remember



Once a programmer has added an explicitly defined constructor to a class, no default constructor will be added to the class by the compiler.

Let's define another class for practice. We learned in a chemistry class that an *element* is the simplest type of matter that consists of exactly one kind of atom. These elements have unique physical and chemical properties. The elements are classified into groups and periods in the *periodic table*. Each element is represented by its

1. name (e. g., hydrogen, helium, lithium, etc.);
2. atomic number (e.g., 1, 2, 3, etc.);
3. atomic symbol (e.g., H, He, Li, etc.);
4. atomic mass (e.g., 1.008, 4.003, 6.941, etc.);

5. period (it ranges from 1 to 7);
6. group (it ranges from 1 to 18 under the new system).

We name the class `Element`. The class has one constructor and six accessors (get methods) for the six attributes. We do not have any mutators (set methods) for this class because once an `Element` object is created we will never change the values of its attributes. Because all of its attributes must be specified, the constructor has six parameters. Here's the `Element` class:

```
class Element {
    //Data Members
    private String name;
    private int    number;
    private String symbol;
    private double mass;
    private int    period;
    private int    group;

    //Constructor
    public Element (String elementName, int elementNumber,
                   String elementSymbol, double elementMass,
                   int elementPeriod, int elementGroup) {

        name    = elementName;
        number  = elementNumber;
        symbol  = elementSymbol;
        mass    = elementMass;
        period  = elementPeriod;
        group   = elementGroup;
    }

    //Returns the element's name
    public String getName () {
        return name;
    }

    //Returns the element's atomic number
    public int    getNumber () {
        return number;
    }

    //Returns the element's 1- or 2-letter symbol
    public String getSymbol () {
        return symbol;
    }
}
```

```

//Returns the element's atomic mass
public double getMass () {
    return mass;
}

//Returns the element's period
public int getPeriod () {
    return period;
}

//Returns the element's group
public int getGroup () {
    return group;
}
}

```

The following sample code creates three Element objects:

```

Element e1, e2, e3;

e1 = new Element ("Hydrogen", 1, "H", 1.008, 1, 1);
e2 = new Element ("Gold", 79, "Au", 197.0, 6, 11);
e3 = new Element ("Oxygen", 8, "O", 16.0, 2, 16);

```

We will introduce sample programs that use the Element class later in the book.

Quick CHECK



1. Which of the following constructors are invalid?

```

public int ClassA(int one) {
    ...
}

public ClassB(int one, int two) {
    ...
}

void ClassC ( ) {
    ...
}

```

2. What is the main purpose of a constructor?

3. Complete the following constructor.

```
class Test {
    private double score;

    public Test(double val) {
        //assign the value of parameter to
        //the data member
    }
}
```

4.6 Information Hiding and Visibility Modifiers

The modifiers `public` and `private` designate the accessibility, or visibility, of data members and methods. Although it is valid in Java, we do not recommend that programmers, especially beginners, leave out the visibility modifier in declaring data members and methods. From the object-oriented design standpoint, we recommend that you always designate the data members and methods as `private` or `public`. We explain how to use these modifiers in this section. But before we get into the details, we first discuss the object-oriented design philosophy behind these modifiers.

Consider a mobile robot as an example. What kind of behavior do we expect from a mobile robot? Behaviors such as moving forward, turning, stopping, and changing speed come to mind easily. When we define a class, say, `MobileRobot`, we will include `public` methods such as `move`, `turn`, `stop`, and `changeSpeed`. These methods are declared `public` so the programmers who use a `MobileRobot` object can call these methods from their programs. We call these programmers *client programmers* and their programs *client programs*.

client
programmers

Now let's assume that the `move` method accepts an integer argument as a distance to travel in meters. Suppose this mobile robot has three wheels with a motor attached to each of the left and right rear wheels. The robot has no steering mechanism, so the turning is done by rotating the left and right rear wheels at different speeds. For example, by rotating the left wheel faster than the right wheel, the robot will make a gradual left turn. To move forward, the robot must send the same amount of power to the two motors. While the motors are rotating, the robot must constantly monitor the distance traveled and stop the motors when the designated distance is traveled.

The `MobileRobot` class includes methods such as `rotate` to rotate the motor and `readDistance` to read the distance traveled. These methods are declared `private` because they are internal details that need to be hidden from the client programmers. From our perspective as a client programmer, all we care is that the mobile robot exhibits the behavior of moving the desired distance when we call its `move` method. We do not care what's going on inside. This is called *information hiding*. It is not our concern how many motors the robot has or what type of mechanism is employed to move the robot. We say the mobile robot *encapsulates* the internal workings.

information
hiding

encapsulation

This encapsulation mechanism allows easier modification of program code. For example, suppose the motion mechanism of a mobile robot is modified to a single motor and rack-and-pinion steering. Both wheels are now connected to a single axle, and the motor turns this axle (via gears). The internal mechanism has changed, but this will not affect the client programs. Calling the move method still exhibits the same behavior.

To implement its methods (both public and private), the `MobileRobot` class will necessarily include many data members, such as current speed, current direction, power levels of the motors, and so forth. These data members are internal details of the class because it is not a concern of the client programmers to know which and how many of them are defined in the class. As such, data members are declared as `private`.

In summary, behavior of the instances is implemented by public methods, while the internal details that must be hidden from the client programmers are implemented by private methods and private data members.

Design Guidelines



Public methods of a class determine the behavior of its instances. Internal details are implemented by private methods and private data members.

Now let's go through a concrete example to see what would happen if something that should be an internal detail is declared public. To illustrate why declaring data members public is considered a bad design, let's consider the `AccountVer2` class. Suppose its data member `balance` is declared as public:

```
class AccountVer2 {
    public double balance;
    //the rest is the same
}
```

You
Might
Want to
Know



Moving a mobile robot forward in reality is actually a far more difficult task than described in the text. First, applying the same power to the two motors does not guarantee the straight movement due to the difference in the motor characteristics and the floor condition. Second, the robot needs to carry out some form of obstacle avoidance, using a device such as a sonar or infrared sensor, because we normally do not want a robot to crash into a wall. Third, stopping is not achieved by abruptly shutting off the power to the motors. This will make the stopping too sudden. We want to gradually reduce the power level so the robot comes to a smooth stop. And there are other complexities involved in actually moving a physical robot.

If this were the class definition, we could not prohibit client programmers from writing code such as

```
AccountVer2 myAcct;
myAcct = new AccountVer2("John Smith", 300.00);
myAcct.balance = 670.00;
```

This breaks the `AccountVer2` class because the balance can be modified directly by the client programmers. The purpose of removing the `setInitialBalance` method is defeated because the client programmers will have direct access to the data member `balance`. They can change its value as they wish. If the instance variable `balance` is properly hidden by declaring it `private`, then the client programmers cannot modify its value directly. They can update the value indirectly only via the `add` and `deduct` methods. This maintains the integrity of the class, because the values of the data members are changed only via the public methods the class designer provides. The client programmers cannot access or modify the data members through the back door.

Design Guidelines



Declaring the data members private ensures the integrity of the class.

To distinguish the private and public components of a class in the program diagram, we use the plus symbol (+) for public and the minus symbol (–) for private. Using these symbols, the diagram that shows both data members and methods for the `AccountVer2` class becomes

AccountVer2
– balance – ownerName
+ AccountVer2(String, double) + add(double) + deduct(double) + getCurrentBalance() + getOwnerName() + setOwnerName(String)



1. If the data member `speed` is private, is the following statement valid in a client program?

```
Robot aibo;
aibo = new Robot();
double currentSpeed = aibo.speed;
```

2. Suppose you wrote down important information, such as your bank account number, student registration ID, and so forth, on a single sheet of paper. Will this sheet be declared *private* and kept in your desk drawer, or *public* and posted on the dorm's front door?
3. Identify the private methods from the following diagram.

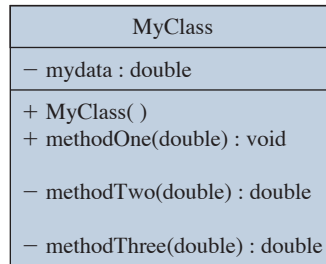

4.7 | Class Constants

We introduced the use of the reserved word `final` in declaring constants in Section 3.3. The constants we declared there were used by only one method—the main method. In this section we will show how a class constant is declared. A class constant will be shared by all methods of the class.

Let's define another version of the `Account` class (the actual name will be `AccountVer3`). This time we will charge a fixed fee whenever a deduction is made. Here's how the class is declared (we will not list the unchanged methods here):

```
class AccountVer3 {
    // Data Members
    private static final double FEE = 0.50;
    private String ownerName;
    private double balance;

    //Constructor
    public AccountVer3(String name, double startingBalance) {
        ownerName = name;
        balance = startingBalance;
    }

    //Deducts the passed amount from the balance
    public void deduct(double amt) {
        balance = balance - amt - FEE;
    }
}
```

Class constant declaration

Fee is charged every time

```

        //other methods are exactly the same as before, so
        //we will omit them here
    }

```

The following sample program shows that the fee of \$1.50 is charged after three deductions.

```

import java.text.*;

class DeductionWithFee {
    //This sample program deducts money three times
    //from the account

    public static void main(String[] args) {

        DecimalFormat df = new DecimalFormat("0.00");
        AccountVer3 acct;

        acct = new AccountVer3("Carl Smith", 50.00);

        acct.deduct(10);
        acct.deduct(10);
        acct.deduct(10);
        System.out.println("Owner: " + acct.getOwnerName());
        System.out.println("Bal : $"
            + df.format(acct.getCurrentBalance()));
    }
}

```

This is the output we get when we run the program:

```

Owner: Carl Smith
Bal : $18.50

```

Notice the use of a `DecimalFormat` object to display the result to two decimal places. Here is the dependency relationship diagram (standard classes are not included)



and the source files for the program are

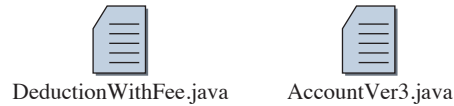

The class constant FEE is declared as

```
private static final double FEE = 0.50;
```

The modifier `final` designates that the identifier `FEE` is a constant, and the modifier `static` designates that it is a class constant. The reserved word `static` is used to declare class components, such as class variables and class methods. The inclusion of the reserved word `static` in the declaration of the main method indicates that it is a class method. It is not so frequent that we use class variables and class methods (except, of course, the main method), and we will not be seeing their examples until later in the book.

Before we move to another example, consider the following (problematic) declaration:

```
class AccountVer3 {
    private final double FEE = 0.50;
    //the rest is the same
}
```

This declaration is not an error, but it is inefficient. If `FEE` is declared as a class constant, then there will be one copy for the class, and this single copy is shared by all instances of the class. If `FEE` is declared without the `static` modifier, then it is an instance constant. This means every instance of the class will have its own copy of the same value. For example, instead of one copy of the value 0.50, there will be 100 copies of the same value 0.50 if there are 100 instances of the class. So, to make effective use of a memory, when we declare a data member as a constant, it should be declared as a class constant. This problem was introduced in Chapter 1, and Figure 1.9 illustrates the problem.

Things to Remember



If a data member is a constant, declare it as a class constant.

Let's try another sample program. This time we will write a class that models a die. Notice how the constants are used in the following Die class:

```
import java.util.Random;
class Die {

    //Data Members

    //the largest number on a die
    private static final int MAX_NUMBER = 6;

    //the smallest number on a die
    private static final int MIN_NUMBER = 1;

    //To represent a die that is not yet rolled
    private static final int NO_NUMBER = 0;

    private int number;

    private Random random;

    //Constructor
    public Die() {
        random = new Random();

        number = NO_NUMBER;
    }

    //Rolls the die
    public void roll( ) {
        number = random.nextInt (MAX_NUMBER - MIN_NUMBER + 1) + MIN_NUMBER;
    }

    //Returns the number on this die
    public int getNumber( ) {
        return number;
    }
}
```

We use the instance variable `number` to store the value of a die after it is rolled. Inside the constructor, we initialize `number` to the constant `NO_NUMBER` to represent the state before the die is rolled. The `roll` method uses the formula for random number generation described in Chapter 3. The minimum and the maximum numbers on a die are kept as the class constants. By changing their values, our software die can be made to represent any range of values, not just 1 to 6. (*Note:* Yes, we can change their values when we edit the class. A Java constant only means that we cannot change its value while the program is running.)

Here's a program that uses three Die objects to simulate a roll of three dice:

```
class RollDice {
    //Simulates the rolling of three dice
    public static void main(String[] args) {
        Die one, two, three;

        one = new Die( );
        two = new Die( );
        three = new Die( );

        one.roll();
        two.roll();
        three.roll();

        System.out.println("Results are " + one.getNumber( ) + " " +
            two.getNumber( ) + " " +
            three.getNumber( ) );
    }
}
```

The dependency diagram and a sample output are as follows:



```
Results are 3 6 5
```

The output of this program is rather primitive, but it still conveys the necessary information. We will learn some drawing techniques in Chapter 5, so we can really draw the image of three dice.

Let's adapt the implementation of the Die class to write another program. Here's the scenario for our next program. Getting a single-occupancy room in a dormitory is very tough because of high demand. There's one especially large and comfortable single-occupancy room in your dorm that everybody covets. The housing office runs a lottery at the beginning of a quarter. Students must submit

their entries before the lottery (if there's no winner, then the room will be auctioned off at eBay). The result of the lottery will consist of three cards. The numbers on a card range from 10 to 15, and the color of a card can be red, green, or blue. Here are some possible outcomes:

13	13	13	draw 1
13	10	15	draw 2
12	11	10	draw 3

We will write a program that will select a winning combination of lottery cards. Following the implementation style of the Die class, we will define a class that models the lottery card. There will be two instance variables, one for color and another for the number. We will use a random number generator to select a color and a number for each lottery card. To represent a color, we will use a simple coding: 1 for red, 2 for green, and 3 for blue.

Here's the LotteryCard class:

```
import java.util.Random;
class LotteryCard {
    // Data Members

    //the largest number on a card
    private static final int MAX_NUMBER = 15;

    //the smallest number on a card
    private static final int MIN_NUMBER = 10;

    //to represent a card before drawing
    private static final int NO_NUMBER = 0;

    //the 'largest' color for a card
    private static final int MAX_COLOR = 3;

    //the 'smallest' color for a card
    private static final int MIN_COLOR = 1;

    //to represent a card before drawing
    private static final int NO_COLOR = 0;

    //selected number on this card
    private int number;

    //selected color of this card
    private int color;
```

```
//random number generator
private Random random;

//Constructor
public LotteryCard( ) {
    random = new Random( );
    number = NO_NUMBER;
    color = NO_COLOR;
}

//spin the card
public void spin( ) {
    number = random.nextInt(MAX_NUMBER - MIN_NUMBER + 1) + MIN_NUMBER;

    color = random.nextInt(MAX_COLOR - MIN_COLOR + 1) + MIN_COLOR;
}

//Returns the number on this card
public int getNumber( ) {
    return number;
}

//Returns the color of this card
public int getColor( ) {
    return color;
}
}
```

And here's the main class that draws the winning card combination:

```
class RoomWinner {

    //Simulates the rolling of three dice
    public static void main(String[] args) {

        LotteryCard one, two, three;

        one = new LotteryCard( );
        two = new LotteryCard( );
        three = new LotteryCard( );

        one.spin();
        two.spin();
        three.spin();

        System.out.println("Winning Card Combination: ");
        System.out.println("1 - red; 2 - green; 3 - blue");
        System.out.println(" ");
    }
}
```

```

System.out.println("          color    number");
System.out.println("Card 1:    " + one.getColor( )
+ "          " + one.getNumber( ) );
System.out.println("Card 2:    " + two.getColor( )
+ "          " + two.getNumber( ) );
System.out.println("Card 3:    " + three.getColor( )
+ "          " + three.getNumber( ) );
}
}

```

The dependency diagram is as follows:



When this program is executed, output similar to the following is displayed:

```

Winning Card Combination:
1 - red; 2 - green; 3 - blue

Card 1:      Color    number
Card 2:      2        13
Card 3:      2        12
Card 3:      1        14

```

Again, the output is rather primitive. We will learn some drawing techniques in Chapter 5 so we can draw the image of a card in the appropriate color.

Public Constants

We stated in Section 4.6 that data members should be declared private to ensure the integrity of a class. Following this guideline, we declared the class constant data members in both sample programs as private. But there is an exception. We may want to declare certain types of class constants as public. Here are the reasons for this exception. First, a constant is “read only” by its nature, so it won’t have a negative impact if we declare it as public. Second, a constant is a clean way to make certain characteristics of the instances known to the client programs.

For example, if we want to make the amount of a fee public knowledge (which is a good idea, because consumers need to know such information), we make the class constant `public` as follows:

```
class AccountVer3 {
    public static final double FEE = 0.50;
    ...
}
```

A client program can then access this information directly as

```
System.out.println("Fee charged per deduction is $ "
    + AccountVer3.FEE);
```

Notice that the class data members are accessed by the syntax

```
<class name> . <class data members>
```

The use of public class constants is quite common in Java, and we will be seeing many examples of it in the later sample programs.



1. Declare two class constants named `MIN_BALANCE` and `MAX_BALANCE` whose data types are `double`.
2. Is there any problem with the following declarations?

```
class Question {
    private final int MAX = 20;
    ...
}
```

3. Modify the `Die` class so its instances will generate a number between 5 and 15, inclusively.

4.8 Local Variables

We often need to use temporary variables while completing a task in a method. Consider the `deduct` method of the `Account` class:

```
public void deduct(double amt) {
    balance = balance - amt;
}
```

We can rewrite the method, using a local variable, as follows:

```
public void deduct(double amt) {
    double newBalance;
```

This is a local variable

```

        newBalance = balance - amt;
        balance = newBalance;
    }

```

local variable

The variable `newBalance` is called a *local variable*. They are declared within the method declaration and used for temporary purposes, such as storing intermediate results of a computation.

Such two-step assignment to update the current balance may not seem so useful here, but consider a situation in which we need to check for certain conditions before actually changing the value of `currentBalance`. For example, we may want to disallow the purchase if the balance goes below a preset minimum balance. So if `newBalance` becomes lower than the set minimum, then we'll leave `balance` unchanged. If we don't use any local variable, then we have to deduct the amount from `balance` (temporarily) and change it back to the previous amount. Use of a temporary local variable will result in a much cleaner code. We will see how such checking is done in Chapter 5 using a selection statement.

The methods in the sample classes from this chapter are still very short, so the use of local variables may not be clear-cut. However, we will witness an increase in the use of local variables in the coming chapters when the methods become complex.

While the data members of a class are accessible from all instance methods of the class, local variables and parameters are accessible only from the method in which they are declared, and they are available only while the method is being executed. Memory space for local variables and parameters is allocated upon declaration and at the beginning of the method, respectively, and erased upon exiting from the method.

Things to Remember



Local variables and parameters are erased when the execution of a method is completed.

When you declare a local variable, make sure the identifier you use for it does not conflict with the data members of a class. Consider the following hypothetical class declaration:

```

class Sample {
    private int number;
    ...
    public void doSomething( ) {
        int number;
        number = 15;
    }
    ...
}

```

This changes the value of the local variable, not the instance variable.

The same identifier is used for both the local variable and the instance variable.

This class declaration is not an error. It is acceptable to use the same identifier for a local variable, but it is not advisable. The following association rules are used:

Things to Remember



Rules for associating an identifier to a local variable, a parameter, and a data member:

1. If there's a matching local variable declaration or a parameter, then the identifier refers to the local variable or the parameter.
2. Otherwise, if there's a matching data member declaration, then the identifier refers to the data member.
3. Otherwise, it is an error because there's no matching declaration.

So the assignment

```
number = 15;
```

will change the value of the local variable. This may or may not be the intent of the programmer. Even if this is the programmer's intention, it is cleaner and easier to read, especially to other programmers, to use different identifiers for local variables.

Things to Remember



Avoid using the same identifier for the local variables and the data members of a class.

Quick CHECK



1. How is a local variable different from an instance variable?
2. Rewrite the following method, using local variables.

```
public int totalCharge(int amt) {
    return (balance -
        (int) Math.round(amt * 1.5));
}
```

4.9 | Calling Methods of the Same Class

Up until now, whenever we called a method of some object, we used dot notation, such as `acct.deduct(12)`. Just as we can call a method of another object, it is possible to

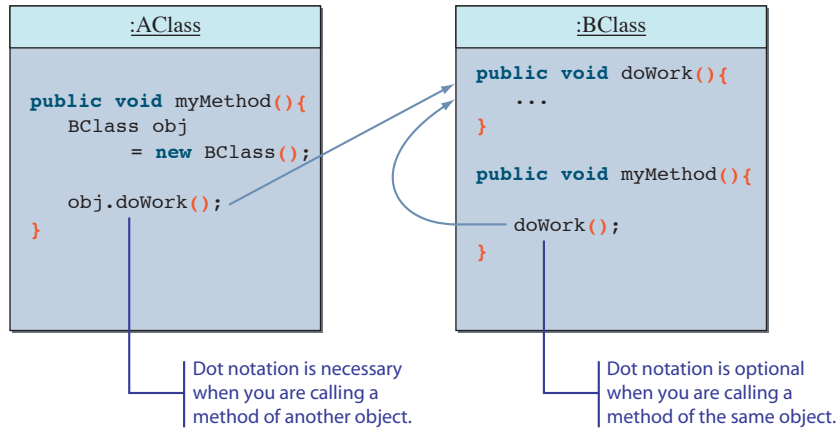

Figure 4.7 The difference between calling a method belonging to the same object and a method belonging to a different object.

call a method from a method of the same object. Figure 4.7 illustrates the difference between calling another method of the same object and calling a method of a different object.

Let's look at a few examples. In the first example, we modify the AccountVer3 class so the add and deduct methods call the private method adjust. Here's how the modified class is declared (the actual class name is AccountVer4, and only the relevant portion is listed here):

```

class AccountVer4 {
    ...

    //Adds the passed amount to the balance
    public void add(double amt) {
        adjust(amt);
    }

    //Deducts the passed amount from the balance
    public void deduct(double amt) {
        adjust( -(amt+FEE) );
    }
    ...

    //Adjusts the account balance
    private void adjust(double adjustAmt) {
        balance = balance + adjustAmt;
    }
}
  
```

The `add` and `deduct` methods differ only in whether you add to or subtract the amount from the balance. In the modified class, we redefine the two methods so they call the common private method `adjust`. This method adds the passed amount to the balance (in the case for the `deduct` method, we pass the negative amount because adding a negative value $-X$ is equivalent to subtracting a positive value X). Here's how the `add` method is defined:

```
public void add(double amt) {
    adjust(amt);
}
```

Notice there is no dot notation. This is calling another method that belongs to the same class.

When we call a method that belongs to the same class, we just include the method name, as follows:

```
adjust(amt);
```

No dot notation is necessary.

Things to Remember



No dot notation is necessary when you call a method from another method of the same class.

Let's look at the second example. In the original `Die` class, when a new instance was created, we set its number to `NO_NUMBER`. This means if a programmer calls the `getNumber` method of a `Die` object before calling its `roll` method, she will get `NO_NUMBER` as a result. For a real die, there's no such `NO_NUMBER` state, so instead of instantiating a new `Die` object in such a state, we'll redefine the class so a die gets rolled when it is first created. The trick here is to call the `roll` method from the constructor. Here's how the modified `Die` class is declared (the class name is `DieVer2`):

```
import java.util.Random;
class DieVer2 {

    //Data Members

    //the largest number on a die
    private static final int MAX_NUMBER = 6;
```



```

//the smallest number on a die
private static final int MIN_NUMBER = 1;

private int number;

private Random random;

//Constructor
public DieVer2( ) {
    random = new Random( ) ;

    roll();
}

//Rolls the die
public void roll( ) {
    number = random.nextInt(MAX_NUMBER - MIN_NUMBER + 1) + MIN_NUMBER;
}

//Returns the number on this die
public int getNumber( ) {
    return number;
}
}

```

The constructor simply calls the roll method. So when a new Die object is created, a number is already preselected. Notice that it is possible to declare the constructor as

```

public DieVer2( ) {
    random = new Random( );
    number = random.nextInt(MAX_NUMBER - MIN_NUMBER + 1)
        + MIN_NUMBER;
}

```

But this ends up duplicating the same code. Instead of repeating the same code in the class, it is much better organizationally to define a single method and call this method from multiple places. Duplication of code, in general, makes the modification of code tedious and error-prone. Imagine the situation in which the same code is repeated at 10 different locations. It is so easy to miss one or two of them at the modification time.

Things to Remember



Avoid duplicating the same code. Duplication of code often means tedious and error-prone activities when you modify the code.

**Quick
CHECK**

1. Suppose a class Alpha includes a method called compute that accepts no arguments. Define another method of Alpha named myMethod that calls the compute method.
2. Why should duplication of code be avoided?

4.10 | Changing Any Class to a Main Class

In this section, we will show you a simple way to make any class (such as Bicycle) also the main class of a program. Instead of defining a separate main class, as we have done so far, it is possible to define the main method to a class so the class becomes the main class of a program also. There are a number of advantages in doing this. First, we have one less class to manage if we don't have to define a separate main class. This advantage may not be seem so substantial. However, when we write numerous classes (e.g., writing solutions to the chapter exercises), writing a separate main class for all those classes so they become executable becomes tedious. Second, when we develop reusable classes (such as Die and Account) for other programmers, we often want to include a simple example on how to use the classes. Instead of providing a separate sample main class, it is more convenient to add the main method to these classes.

We illustrate the procedure, using the Bicycle class from Section 4.1. Suppose we want to show a sample use of this class. Instead of creating a separate sample main class, we can define the main method to the Bicycle class. Here's the Bicycle class that is also a main class:

```
class Bicycle {  
    // Data Member  
    private String ownerName;  
  
    //Returns the name of this bicycle's owner  
    public String getOwnerName( ) {  
        return ownerName;  
    }  
  
    //Assigns the name of this bicycle's owner  
    public void setOwnerName(String name) {  
        ownerName = name;  
    }  
  
    //The main method that shows a sample  
    //use of the Bicycle class  
    public static void main(String[] args) {  
        Bicycle myBike;  
        myBike = new Bicycle( );  
    }  
}
```

```

        myBike.setOwnerName("Jon Java");
        System.out.println(myBike.getOwnerName() +
                           "owns a bicycle");
    }
}

```

Remember that the new `Bicycle` class having the main method does not prohibit us from defining a separate main class. All Java requires us to do is to include the main method to the classes we designate as the main class of the program. So it is possible (although not likely) that every class in the program has the main method, and we can select one of them to be the main class when we execute the program. We will use this technique whenever appropriate in the textbook, beginning with this chapter's sample development section.

Things to Remember



Any class can include the main method. For a program to be executable, the designated main class must include the main method. Other classes in the program may or may not include the main method. It is irrelevant to the execution of the program.

4.11 Sample Development

Loan Calculator

In Chapter 3, we wrote a loan calculator program that computes the monthly and total payments for a given loan amount, loan period, and interest rate. We wrote the program using the simplified program structure in which we had one main class with one method (**main**). We will implement the program again, but this time we use classes called **Loan** and **LoanCalculator**.

Problem Statement

The problem statement is the same as that in Chapter 3. We repeat the statement to refresh your memory:

Write a loan calculator program that computes both monthly and total payments for a given loan amount, annual interest rate, and loan period.

Overall Plan

The tasks we identified in Chapter 3 for the program are still the same:

1. Get three input values: **loanAmount**, **interestRate**, and **loanPeriod**.
2. Compute the monthly and total payments.
3. Output the results.

program
tasks

The main difference in this implementation lies in the use of additional classes. Instead of building the program by using only the main class and performing all the tasks in one big **main** method, we will define two classes **Loan** and **LoanCalculator**. An instance of the **LoanCalculator** class acts as a top-level agent that manages all other objects in the program, such as **Loan** and **Scanner**. The **Loan** class captures the logic of loan calculation. A single instance of the **Loan** class represents a loan, so if the program deals with five loans, for example, then five **Loan** objects will be created in the program. We will make the **LoanCalculator** class the main class of the program by adding the **main** method to it. Figure 4.8 shows the program diagram.

Notice that the roles that **LoanCalculator** and **Loan** play in the program are quite different. The **Loan** class is a generic class that provides a service (e.g., loan computation and currency conversion) and is intended to be reused by different programs. The **LoanCalculator** class, on the other hand, is a class designed specifically for this program, so the class is not intended for reuse by other programs. It is important to recognize this distinction because the way we design reusable and nonreusable classes is quite different. We call the class that provides some type of service a **service provider** and the class that manages other classes and objects in a program a **controller**. In general, a service provider is designed as a reusable class, while a controller is designed as a nonreusable class.

What would be the development steps for this program? If we have multiple classes to implement, we can develop the program in either a top-down or a bottom-up manner. With the **top-down development**, we develop in a kind of outside-in fashion. We develop the top-level controller class first. But to test its functionalities fully, we need the service objects it uses. In a top-down development, we use temporary dummy service objects that return a fake value from their methods. After we verify that the controller class is working correctly, we then complete the service class with the real methods. The top-down development for this program will implement the **LoanCalculator** class first with the dummy **Loan** class and then the real **Loan** class.

service
provider

controller

top-down
develop-
ment

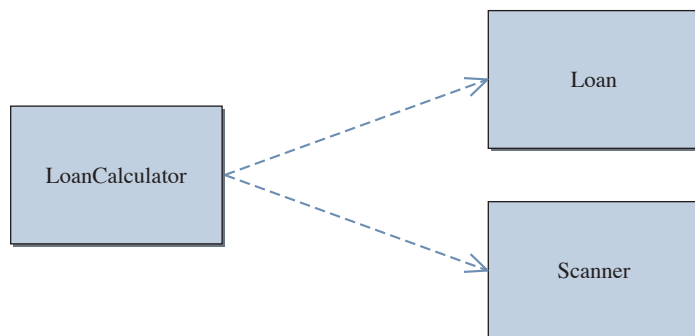

Figure 4.8 The program diagram for the **LoanCalculator** program.

4.11 Sample Development—*continued*

bottom-up
develop-
ment

With the **bottom-up development**, we develop in the reverse inside-out fashion; that is, we develop the service classes first. To test the service classes, we write a temporary dummy main class. After the service classes are done, we complete the top-level class that uses these service classes. The bottom-up development for this program implements the **Loan** class first fully and then the **LoanCalculator** class. For both approaches, the classes are developed incrementally as usual.

For this sample development, we will adopt the top-down development. We will leave the bottom-up development for this program as an exercise. For some sample applications in the later chapters, we will adopt the bottom-up development. We implement this program in five steps:

develop-
ment steps

1. Start a skeleton of the **LoanCalculator** class. The skeleton **LoanCalculator** class will include only an object/variable declaration and a constructor to create objects. Define a temporary placeholder **Loan** class.
2. Implement the input routine to accept three input values.
3. Implement the output routine to display the results.
4. Implement the computation routine to compute the monthly and total payments.
5. Finalize the program, implementing any remaining temporary methods and adding necessary methods as appropriate.

Step 1 Development: Program Skeleton

step 1
design

Since the **LoanCalculator** object is the top-level agent of the program that manages other objects, we need a method to create these objects. We do this in the constructor. We define separate methods for input, computation, and output to organize the class more logically. Designing a set of single-task methods is more manageable and easier to understand than having one method that performs all three tasks of input, computation, and output. We will call the methods **getInput**, **computePayment**, and **displayOutput**. We will also include one method called **describeProgram** that describes the purpose of the program to the user.

Since an instance of the class is the top-level agent, much as a general contractor, we will provide one method the programmer can call to control the whole operation. We will name the method **start** and define it as follows:

```
public void start( ) {
    describeProgram();
    getInput();
    computePayment();
    displayOutput();
}
```

With this method, we can then call the **main** method as follows:

```
public static void main(String[] args){
    LoanCalculator calculator = new LoanCalculator();
    calculator.start();
}
```

It is possible to define the **main** method to make it call the four operation methods (**describeProgram**, **computePayment**, **getInput**, and **displayOutput**) directly, eliminating the need to define the **start** method. However, such organization limits the flexibility and usability of the class. By defining the **start** method, if other programmers want to use the **LoanCalculator** class in their programs, they need only call the **start** method. Without the **start** method, they have to call the four methods and remember to call them in the correct order. Although the difference is not dramatic in this particular case, it can be in the cases when the classes are more complex and the number of classes in a program is large.

Let's summarize the methods we will define for the **LoanCalculator** class:

Design Document: The LoanCalculator Class		
Method	Visibility	Purpose
<code>start</code>	public	Carries out the loan calculation by calling the other private methods.
<code>computePayment</code>	private	Given three parameters—loan amount, loan period, and interest rate—it computes monthly and total payments. The actual computation is done by a Loan object.
<code>describeProgram</code>	private	Displays a short description of the program.
<code>displayOutput</code>	private	Displays the result—monthly and total payments.
<code>getInput</code>	private	Uses Scanner to get three input values—loan amount, loan period, and interest rate.

Notice that only the **start** method is **public**. We declare all other methods as **private** because we do not want any client programmers to use them directly; we want the client programmers to be able to call only the **start** method.

In this step, we define the four private methods with only a temporary output statement inside the method body to verify that the methods are called correctly. A method that has no “real” statements inside the method body is called a **stub**. The four

stub

4.11 Sample Development—continued

methods are defined as follows:

```
private void describeProgram() {
    System.out.println("inside describeProgram"); //TEMP
}
private void getInput() {
    System.out.println("inside getInput"); //TEMP
}
private void computePayment() {
    System.out.println("inside computePayment"); //TEMP
}
private void displayOutput() {
    System.out.println("inside displayOutput"); //TEMP
}
```

Notice the comment marker **//TEMP** after the output statements. It is our convention to attach this comment marker so we can easily and quickly locate temporary statements. We use **System.out** for temporary output.

The purpose of the skeleton **LoanCalculator** class is to declare and create all the necessary data members. At this step, we know of only one object that will be used by **LoanCalculator**, namely, a **Loan** object. The declaration part of the **LoanCalculator** class will be as follows:

```
class LoanCalculator {
    private Loan loan;
    ...
}
```

At this point, the constructor for the **LoanCalculator** class is very simple. The only data member is a **Loan** object, so we will create it in the constructor as follows:

```
public LoanCalculator( ) {
    loan = new Loan( );
}
```

For this constructor to work properly, we need the definition for the **Loan** class. We begin with the minimalist skeleton code for the **Loan** class:

```
class Loan {
    public Loan( ) {
    }
}
```

step 1 code

Let's put our design in an actual code. The skeleton **LoanCalculator** class is defined as follows.

```

/*
  Chapter 4 Sample Development: Loan Calculation (Step 1)
  File: Step1/LoanCalculator.java
  */

class LoanCalculator {

    //Data members
    private Loan loan;

    //Main method
    public static void main(String[] arg) {
        LoanCalculator calculator = new LoanCalculator();
        calculator.start();
    }

    //Constructor
    public LoanCalculator() {

        loan = new Loan();
    }

    // Top-level method that calls other private methods
    public void start() {

        describeProgram(); //tell what the program does
        getInput(); //get three input values
        computePayment(); //compute the monthly payment and total
        displayOutput(); //display the results
    }

    // Computes the monthly and total loan payments
    private void computePayment() {

        System.out.println("inside computePayment"); //TEMP
    }

    // Provides a brief explanation of the program to the user
    private void describeProgram() {

        System.out.println("inside describeProgram"); //TEMP
    }

    // Displays the input values and monthly and total payments
    private void displayOutput() {

        System.out.println("inside displayOutput"); //TEMP
    }
}

```

4.11 Sample Development—continued

```
// Gets three input values—loan amount, interest rate, and
// loan period—using an InputBox object
private void getInput() {
    System.out.println("inside getInput"); //TEMP
}
}
```

And finally the skeleton **Loan** class is defined as follows.

```
/*
    Chapter 4 Sample Development: Loan Calculation (Step 1)
    File: Step1/Loan.java
*/
class Loan {
    public Loan( ) {
    }
}
```

step 1 test

We run the step 1 program and verify that the following text appears in the standard output window:

```
inside describeProgram
inside getInput
inside computePayment
inside displayOutput
```

After the step 1 program is compiled and executed correctly, we move on to step 2.

Step 2 Development: Accept Input Valuesstep 2
design

In the second step of coding, we implement the **getInput** method. We will reuse the input routine we derived in Chapter 3. When we receive three input values, we must pass these values to the **Loan** object **loan**. We will add three data members to keep track of

the three input values and one constant to aid the conversion:

```
class Loan {
    private static final int MONTHS_IN_YEAR = 12;
    private double loanAmount;
    private double monthlyInterestRate;
    private int numberOfPayments;
    ...
}
```

Notice that the annual interest rate and loan period expressed in the number of years are the input, but we are keeping monthly interest rate and the number of monthly payments for the loan period to make them more compatible to the loan calculation formula we are using. We need to define three set methods (mutators) for interest rate, loan period, and loan amount. A set method for the number of payments, for example, can be defined as follows:

```
public void setPeriod(int periodInYear) {
    numberOfPayments = periodInYear * MONTHS_IN_YEAR;
}
```

We define a complementary set of accessor methods. The **getPeriod** method, for example, is defined as

```
public int getPeriod( ) {
    return (numberOfPayments / MONTHS_IN_YEAR);
}
```

Notice that the value returned by an accessor may or may not be the data member. It is possible that the value returned is derived from the data member, as was the case with the **getLoanPeriod** method.

We mentioned in Section 4.4 the importance of a constructor initializing an object properly. Now that we have associated data members to the **Loan** class, let's define a constructor that accepts arguments:

```
public Loan(double amount, double rate, int period) {
    setAmount(amount);
    setRate (rate );
    setPeriod(period);
}
```

Having this updated **Loan** class, we are now ready to tackle the **getInput** method of the **LoanCalculator** class. We perform the input routine as we did in the sample program from Chapter 3:

```
Scanner scanner = new Scanner(System.in);

System.out.print("Loan Amount (Dollars+Cents): ");
loanAmount = scanner.nextDouble();
```

4.11 Sample Development—continued

```

System.out.print("Annual Interest Rate (e.g., 9.5): ");
annualInterestRate = scanner.nextDouble();

System.out.print("Loan Period - # of years: ");
loanPeriod = scanner.nextInt();

```

After getting three input values, we create a new **Loan** object as

```

loan = new Loan(loanAmount,
               annualInterestRate,
               loanPeriod);

```

Finally, we include test output statements to verify that the values are read in and assigned to loan correctly:

```

System.out.println("Loan Amount: $"
                  + loan.getAmount());
System.out.println("Annual Interest Rate:"
                  + loan.getRate() + "%");
System.out.println("Loan Period (years):"
                  + loan.getPeriod());

```

step 2 code

From this point on, to maintain a focus on the changes we are making, we show only the portion where we made modifications or additions. Unchanged portions are represented by three dots (. . .). Please refer to the actual source file for the viewing of complete source code. Here's the step 2 **LoanCalculator** class:

```

/*
Chapter 4 Sample Development: Loan Calculation (Step 2)
File: Step2/LoanCalculator.java
*/

import java.util.*;

class LoanCalculator {
    . . .

    public LoanCalculator() {
    }

    . . .

    private void getInput(){
        double loanAmount, annualInterestRate;

```

```

    int    loanPeriod;

    Scanner scanner = new Scanner(System.in);

    System.out.print("Loan Amount (Dollars+Cents):");
    loanAmount = scanner.nextDouble();

    System.out.print("Annual Interest Rate (e.g., 9.5):");
    annualInterestRate = scanner.nextDouble();

    System.out.print("Loan Period - # of years:");
    loanPeriod = scanner.nextInt();

    //create a new loan with the input values
    loan = new Loan(loanAmount, annualInterestRate,loanPeriod);

    //TEMP
    System.out.println("Loan Amount: $" + loan.getAmount());
    System.out.println("Annual Interest Rate:"
        + loan.getRate() + "%");

    System.out.println("Loan Period (years):" + loan.getPeriod());

    //TEMP
}
. . .
}

```

The step 2 **Loan** class is as follows:

```

/*
  Chapter 4 Sample Development: Loan Calculation (Step 2)
  File: Step2/Loan.java
*/

class Loan {

    private final int MONTHS_IN_YEAR = 12;

    private double    loanAmount;

    private double    monthlyInterestRate;

    private int       numberOfPayments;

```

4.11 Sample Development—continued

```

//Constructor
public Loan(double amount, double rate, int period) {
    setAmount(amount);
    setRate (rate );
    setPeriod(period);
}

//Returns the loan amount
public double getAmount( ) {
    return loanAmount;
}

//Returns the loan period in number of years
public int getPeriod( ) {
    return numberOfPayments / MONTHS_IN_YEAR;
}

//Returns the loan's annual interest rate
public double getRate( ) {
    return monthlyInterestRate * 100.0 * MONTHS_IN_YEAR;
}

//Sets the loan amount
public void setAmount(double amount) {
    loanAmount = amount;
}

//Sets the annual interest rate
public void setRate(double annualRate) {
    monthlyInterestRate = annualRate / 100.0 / MONTHS_IN_YEAR;
}

//Sets the loan period
public void setPeriod(int periodInYears) {
    numberOfPayments = periodInYears * MONTHS_IN_YEAR;
}
}

```

step 2 test

As before, to verify the input routine is working correctly, we run the program multiple times. For each run, we enter a different set of data to verify that the values entered are displayed correctly.

step 3
design

Step 3 Development: Output Values

In the third step of development, we implement the **displayOutput** method. We will reuse the design of output layout from Chapter 3. The actual task of computing the monthly and total payments is now delegated to the **Loan** class, so we will add two methods—**getMonthlyPayment** and **getTotalPayment**—to the **Loan** class. The focus in step 3 is the layout for output, so we will define a temporary dummy code for these two methods in the following manner:

```
public double getMonthlyPayment( ) {
    return 132.15; //TEMP
}

public double getTotalPayment( ) {
    return 15858.10; //TEMP
}
```

To display the monthly and total payments, we add the following code in the **displayOutput** method:

```
private void displayOutput( ) {
    //echo print the input values here
    System.out.println("Monthly payment is $ " +
        loan.getMonthlyPayment() );
    System.out.println(" TOTAL payment is $ " +
        loan.getTotalPayment() );
}
```

Notice that by defining the **getMonthlyPayment** and **getTotalPayment** methods in the **Loan** class, the **computePayment** method of **LoanCalculator** becomes redundant and no longer needed. So we will remove it in this step.

step 3 code

Here are the modified **LoanCalculator** and **Loan** classes:

```
/*
  Chapter 4 Sample Development: Loan Calculation (Step 3)
  File: Step3/LoanCalculator.java
  */

import java.util.*;

class LoanCalculator {
    ...
    // computePayment method is removed from the source file
    private void displayOutput() {
        System.out.println("Loan Amount: $" + loan.getAmount());
    }
}
```

4.11 Sample Development—continued

```

        System.out.println("Annual Interest Rate:"
            + loan.getRate() + "%");
        System.out.println("Loan Period (years): " + loan.getPeriod());
        System.out.println("Monthly payment is $ " +
            loan.getMonthlyPayment());
        System.out.println("  TOTAL payment is $ " +
            loan.getTotalPayment());
    }

    private void getInput() {
        //same code but the temporary echo print statements
        //are removed
    }
}

```

```

/*
   Chapter 4 Sample Development: Loan Calculation (Step 3)
   File: Step3/Loan.java
*/
class Loan {
    ...
    public double getMonthlyPayment( ) {
        return 132.15; //TEMP
    }
    public double getTotalPayment( ) {
        return 15858.10; //TEMP
    }
    ...
}

```

step 3 test

To verify the output routine is working correctly, we run the program multiple times and verify that the layout looks okay for different values. It is common for a programmer to run the program several times before the layout looks clean on the screen.

Step 4 Development: Compute Loan Amount

step 4
design

In the fourth step of development, we replace the temporary **getMonthlyPayment** and **getTotalPayment** methods with the final version. The changes are made only to the **Loan** class. The other two classes remain the same.

Here's one possible way to define the two methods:

```
private double monthlyPayment;

public double getMonthlyPayment( ) {
    monthlyPayment = ...;
    return monthlyPayment;
}

public double getTotalPayment( ) {
    return monthlyPayment * numberOfPayments;
}
```

The idea is to use the value of the data member **monthlyPayment** set by the **getMonthlyPayment** method in computing the total payment. This setup is problematic because the **getTotalPayment** method will not work correctly unless **getMonthlyPayment** is called first. It is considered a very poor design, and generally unacceptable, to require the client programmer to call a collection of methods in a certain order. We must define the two methods so they can be called in any order, not necessarily in the order of **getMonthlyPayment** and **getTotalPayment**. The correct way here is to call **getMonthlyPayment** from the **getTotalPayment** method:

```
private double getTotalPayment( ) {
    double totalPayment;

    totalPayment = getMonthlyPayment() * numberOfPayments;

    return totalPayment;
}
```

step 4 code

With this approach the data member **monthlyPayment** is not necessary. Here's the updated **Loan** class:

```
/*
  Chapter 4 Sample Development: Loan Calculation (Step 4)
  File: Step4/Loan.java
  */

class Loan {
    ...
    public double getMonthlyPayment( ) {
        double monthlyPayment;
```

4.11 Sample Development—continued

```

        monthlyPayment = (loanAmount * monthlyInterestRate)
                        /
                        (1 - Math.pow(1/(1 + monthlyInterestRate),
                                      numberOfPayments ) );
    }
    return monthlyPayment;
}

public double getTotalPayment( ) {
    double totalPayment;

    totalPayment = getMonthlyPayment( ) * numberOfPayments;

    return totalPayment;
}
...
}

```

step 4 test

After the method is added to the class, we need to run the program through a number of test data. As in Chapter 3, we made the assumption that the input values must be valid, so we will only test the program for valid input values. For sample test data, we repeat the table from Chapter 3. The right two columns show the correct results. Remember that these input values are only suggestions, not a complete list of test data. You must try other input values as well.

Input			Output (shown up to three decimal places only)	
Loan Amount	Annual Interest Rate	Loan Period (in Years)	Monthly Payment	Total Payment
10000	10	10	132.151	15858.088
15000	7	15	134.824	24268.363
10000	12	10	143.471	17216.514
0	10	5	0.000	0.000
30	8.5	50	0.216	129.373

step 5 design

Step 5 Development: Finalize

Now in the last step of development, we finalize the class declaration by completing the **describeProgram** method, the only method still undefined. We may give a very long

description or a very terse one. An ideal program will let the user decide. We do not know how to write such code yet, so we will display a short description of the program using **System.out**.

Another improvement is the display of monetary values in two decimal places. We can format the display to two decimal places by using the **DecimalFormat** class as explained in Chapter 3.

step 5 code

Here's the **describeProgram** method;

```
private void describeProgram() {
    System.out.println
        ("This program computes the monthly and total");
    System.out.println
        ("payments for a given loan amount, annual ");
    System.out.println
        ("interest rate, and loan period (# of years).");
    System.out.println("\n");
}
```

step 5 test

You may feel that there's not much testing we can do in this step. After all, we add only a single method that carries out a simple output routine. However, many things can go wrong between step 4 and step 5. You may have deleted some lines of code inadvertently. You may have deleted a necessary file by mistake. Anything could happen. The point is to test after every step of development to make sure everything is in order.

Summary

- Data members of a class refer to the instance and class variables and constants of the class.
- An object's properties are maintained by a set of data members.
- Class methods can access only the class variables and class constants.
- Instance methods can access all types of data members of the class.
- Public methods define the behavior of an object.
- Private methods and data members (except certain class constants) are considered internal details of the class.
- Components (data members and methods) of a class with the visibility modifier `private` cannot be accessed by the client programs.
- Components of a class with the visibility modifier `public` can be accessed by the client programs.
- A method may or may not return a value. One that does not return a value is called a void method.

- A *constructor* is a special method that is executed when a new object is created. Its purpose is to initialize the object into a valid state.
- Memory space for local variables and parameters is allocated when a method is called and deallocated when the method terminates.
- A public method that changes a property of an object is called a *mutator*.
- A public method that retrieves a property of an object is called an *accessor*.
- Dot notation is not used when you call a method from another method of the same class.
- Any class can be set as the main class of a program by adding the main method to it. In the main method, an instance of this class is created.

Key Concepts

programmer-defined classes	parameters
accessibility (visibility) modifiers	client programmers
void methods	information hiding
value-returning methods	encapsulation
accessors	local variables
mutators	service providers
constructors	controllers
arguments	stub

Chapter 4 Exercises

Review Exercises

1. Consider the following class declaration.

```
class QuestionOne {
    public final int A = 345;
    public int b;
    private float c;

    private void methodOne( int a) {
        b = a;
    }

    public float methodTwo( ) {
        return 23;
    }
}
```

Identify invalid statements in the following main class. For each invalid statement, state why it is invalid.

```
class Q1Main {
    public static void main(String[] args) {
        QuestionOne q1;
        q1 = new QuestionOne( );

        q1.A = 12;
        q1.b = 12;
        q1.c = 12;

        q1.methodOne(12);
        q1.methodOne( );
        System.out.println(q1.methodTwo(12));
        q1.c = q1.methodTwo( );
    }
}
```

2. What will be the output from the following code?

```
class Q2Main {
    public static void main(String[] args) {
        QuestionTwo q2;
        q2 = new QuestionTwo( );
        q2.init();

        q2.increment();
        q2.increment();

        System.out.println(q2.getCount());
    }
}
```

```
class QuestionTwo {
    private int count;

    public void init( ) {
        count = 1;
    }

    public void increment( ) {
        count = count + 1;
    }

    public int getCount( ) {
        return count;
    }
}
```

3. What will be the output from the following code? Q3Main and Question Three classes are the slightly modified version of Q2Main and QuestionTwo.

```

class Q3Main {
    public static void main(String[] args) {
        QuestionThree q3;
        q3 = new QuestionThree( );
        q3.init();

        q3.count = q3.increment() + q3.increment();

        System.out.println(q3.increment());
    }
}

class QuestionThree {
    public int count;

    public void init( ) {
        count = 1;
    }

    public int increment( ) {
        count = count + 1;
        return count;
    }
}

```

4. Is there any problem with the following class? Is the passing of an argument to the private methods appropriate? Are the data members appropriate? Explain.

```

/*
Problem Question4
*/
class MyText {

    private String word;
    private String temp;
    private int    idx;

    public String firstLetter( ) {
        idx = 0;
        return getLetter(word);
    }

    public String lastLetter( ) {
        idx = word.length() - 1;
        return getLetter(word);
    }
}

```

```

private String getLetter(String str) {
    temp = str.substring(idx, idx+1);
    return temp;
}
}

```

Level 1 Programming Exercises ★

- In the RollDice program, we created three Die objects and rolled them once. Rewrite the program so you will create only one Die object and roll it three times.
- Write a program that computes the total ticket sales of a concert. There are three types of seatings: A, B, and C. The program accepts the number of tickets sold and the price of a ticket for each of the three types of seats. The total sales are computed as follows:

$$\begin{aligned} \text{totalSales} = & \text{numberOfA_Seats} * \text{pricePerA_Seat} + \\ & \text{numberOfB_Seats} * \text{pricePerB_Seat} + \\ & \text{numberOfC_Seats} * \text{pricePerC_Seat}; \end{aligned}$$

Write this program, using only one class, the main class of the program.

- Define a new class named Temperature. The class has two accessors—toFahrenheit and toCelsius—that return the temperature in the specified unit and two mutators—setFahrenheit and setCelsius—that assign the temperature in the specified unit. Maintain the temperature internally in degrees Fahrenheit. Using this class, write a program that inputs temperature in degrees Fahrenheit and outputs the temperature in equivalent degrees Celsius.
- Using the Temperature class from Exercise 7, write a program that inputs temperature in degrees Celsius and outputs the temperature in equivalent degrees Fahrenheit.
- Write a program that computes the area of a circular region (the shaded area in the diagram), given the radii of the inner and the outer circles, r_i and r_o , respectively.

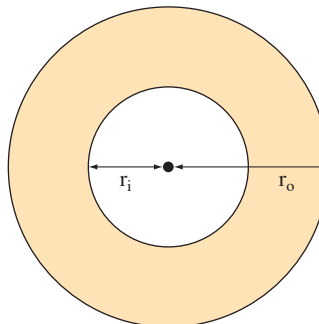

We compute the area of the circular region by subtracting the area of the inner circle from the area of the outer circle. Define a `Circle` class that has methods to compute the area and circumference. You set the circle's radius with the `setRadius` method or via a constructor.

10. Modify the `Bicycle` class so instead of assigning the name of an owner (`Student`), you can assign the owner object itself. Model this new `Bicycle` class after the `LibraryCard` class.

Level 2 Programming Exercises ★★

11. Extend the `LibraryCard` class by adding the expiration date as a new property of a library card. Define the following four methods:

```
//sets the expiration date
public void setExpDate(GregorianCalendar date) {...}

//returns the expiration year
public int getExpYear( ) { ... }

//returns the expiration month
public int getExpMonth( ) { ... }

//returns the expiration day
public int getExpDay( ) { ... }
```

12. Write a program that displays the recommended weight (kg), given the user's age and height (cm). The formula for calculating the recommended weight is

$$\text{recommendedWeight} = (\text{height} - 100 + \text{age} / 10) * 0.90$$

Define a service class named `Height` and include an appropriate method for getting a recommended weight of a designated height.

13. Redo Exercise 9 by using a `Seat` class. An instance of the `Seat` class keeps track of the ticket price for a given type of seat (A, B, or C).
14. Write a `WeightConverter` class. An instance of this class is created by passing the gravity of an object relative to the Earth's gravity (see Exercise 16 on page 144). For example, the Moon's gravity is approximately 0.167 of the Earth's gravity, so we create a `WeightConverter` instance for the Moon as

```
WeightConverter moonWeight;
moonWeight = new WeightConverter( 0.167 );
```

To compute how much you weigh on the Moon, you pass your weight on Earth to the `convert` method as

```
yourMoonWeight = moonWeight.convert( 160 );
```

Use this class and redo Exercise 16 on page 144.

Development Exercises

For the following exercises, use the incremental development methodology to implement the program. For each exercise, identify the program tasks, create a design document with class descriptions, and draw the program diagram. Map out the development steps at the start. Present any design alternatives and justify your selection. Be sure to perform adequate testing at the end of each development step.

15. Redo Exercise 30 on page 149, but this time define and use programmer-defined classes.
16. Write a program that accepts the unit weight of a bag of coffee in pounds and the number of bags sold and displays the total price of the sale, computed as follows:

```
totalPrice      = bagWeight * numberOfBags * pricePerLb;
totalPriceWithTax = totalPrice + totalPrice * taxrate;
```

Display the result in the following manner:

```
Number of bags sold: 32
  Weight per bag: 5 lb
  Price per pound: $5.99
  Sales tax: 7.25%

  Total price: $ 1027.88
```

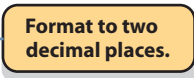

Define and use a programmer-defined `CoffeeBag` class. Include class constants for the price per pound and tax rate with the values \$5.99 per pound and 7.25 percent, respectively.

17. In the Turtle exercises from the earlier chapters, we dealt with only one Turtle (e.g., see Exercise 32 on page 150). It is possible, however, to let multiple turtles draw on a single drawing window. To associate multiple turtles to a single drawing, we create an instance of `TurtleDrawingWindow` and add turtles to it as follows:

```
TurtleDrawingWindow canvas = new TurtleDrawingWindow( );
Turtle winky, pinky, tinky;

//create turtles;
//pass Turtle.NO_DEFAULT_WINDOW as an argument so
//no default drawing window is attached to a turtle.
winky = new Turtle(Turtle.NO_DEFAULT_WINDOW);
pinky = new Turtle(Turtle.NO_DEFAULT_WINDOW);
tinky = new Turtle(Turtle.NO_DEFAULT_WINDOW);

//now add turtles to the drawing window
canvas.add( winky );
canvas.add( pinky );
canvas.add( tinky );
```

Ordinarily, when you start sending messages such as `turn` and `move` to a `Turtle`, it will begin moving immediately. When you have only one `Turtle`, this is fine. However, if you have multiple turtles and want them to start moving at the same time, you have to first pause them, then give instructions, and finally command them to start moving. Here's the basic idea:

```
winky.pause( );
pinky.pause( );
tinky.pause( );
//give instructions to turtles here,
//e.g., pinky.move(50); etc.

//now let the turtles start moving
winky.start( );
pinky.start( );
tinky.start( );
```

Using these `Turtle` objects, draw the following three triangles:

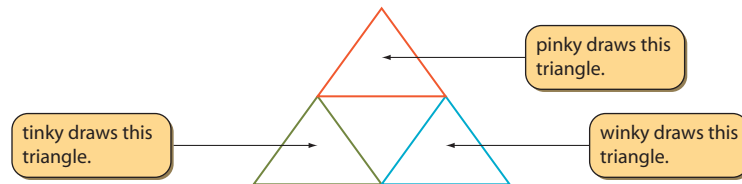

Use a different pen color for each triangle. Run the same program without pausing and describe what happens.

Selection Statements

5

O b j e c t i v e s

After you have read and studied this chapter, you should be able to

- Implement selection control in a program using **if** statements.
- Implement selection control in a program using **switch** statements.
- Write boolean expressions using relational and boolean operators.
- Evaluate given boolean expressions correctly.
- Nest an **if** statement inside another **if** statement's **then** or **else** part correctly.
- Describe how objects are compared.
- Choose the appropriate selection control statement for a given task.
- Define and use enumerated constants.
- Draw geometric shapes on a window.

Introduction



D

ecisions, decisions, decisions. From the moment we are awake until the time we go to sleep, we are making decisions. Should I eat cereal or toast? What should I wear to school today? Should I eat at the cafeteria today? And so forth. We make many of these decisions by evaluating some criteria. If the number of students in line for registration seems long, then come back tomorrow for another try. If today is Monday, Wednesday, or Friday, then eat lunch at the cafeteria.

Computer programs are no different. Any practical computer program contains many statements that make decisions. Often a course of action is determined by evaluating some kind of a test (e.g., Is the remaining balance of a meal card below the minimum?). Statements in programs are executed in sequence, which is called *sequential execution* or *sequential control flow*. However, we can add decision-making statements to a program to alter this control flow. For example, we can add a statement that causes a portion of a program to be skipped if an input value is greater than 100. Or we can add a statement to disallow the purchase of food items if the balance of a meal card goes below a certain minimum. The statement that alters the control flow is called a *control statement*. In this chapter we describe some important control statements, called *selection statements*. In Chapter 6 we will describe other control statements, called *repetition statements*.

sequential
execution

control
statement

5.1 The if Statement

if statement

There are two versions of the *if statement*, called *if-then-else* and *if-then*. We begin with the first version. Suppose we wish to enter a student's test score and print out the message You did not pass if the score is less than 70 and You did pass if the score is 70 or higher. Here's how we express this logic in Java:

```
Scanner scanner = new Scanner(System.in);
System.out.print("Enter test score: ");
int testScore = scanner.nextInt();
if (testScore < 70)
    System.out.println("You did not pass");
else
    System.out.println("You did pass");
```

This statement is
executed if **testScore**
is less than 70.

This statement is
executed if **testScore**
is 70 or higher.

We use an if statement to specify which block of code to execute. A block of code may contain zero or more statements. Which block is executed depends on the

Hints,
& Tips,
Pitfalls

One very common error in writing programs is to mix up the assignment and equality operators. We frequently make the mistake of writing

```
if (x = 5) ...
```

when we actually wanted to say

```
if (x == 5) ...
```

If the boolean expression evaluates to true, then the statements in the <then block> are executed. Otherwise, the statements in the <else block> are executed. We will cover more complex boolean expressions in Section 5.2. Notice that we can reverse the relational operator and switch the then and else blocks to derive the equivalent code, for example,

```
if (testScore >= 70)
    System.out.println("You did pass");
else
    System.out.println("You did not pass");
```

Notice that the reverse of < is >=, not >.

selection
statement

The if statement is called a *selection* or *branching statement* because it selects (or branches to) one of the alternative blocks for execution. In our example, either

```
System.out.println("You did not pass");
```

or

```
System.out.println("You did pass");
```

is executed depending on the value of the boolean expression. We can illustrate a branching path of execution with the diagram shown in Figure 5.2.

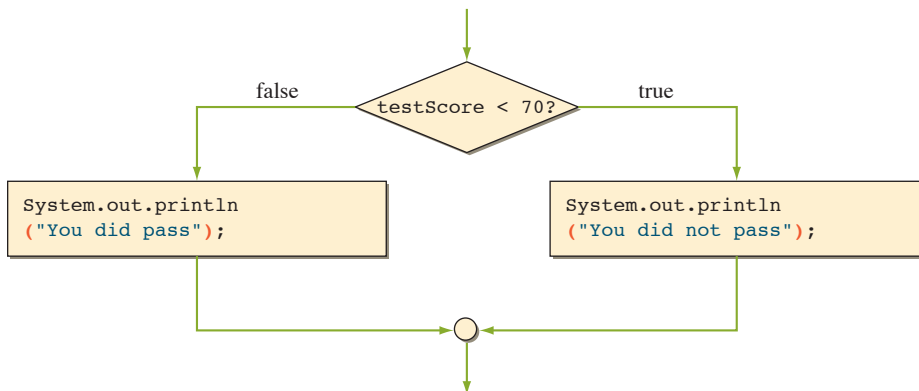

Figure 5.2 The diagram showing the control flow of the sample if-then-else statement.

In the preceding if statement, both blocks contain only one statement. The then or else block can contain more than one statement. The general format for both the <then block> and the <else block> is either a

```
<single statement>
```

or a

```
<compound statement>
```

where <single statement> is a Java statement and <compound statement> is a sequence of Java statements surrounded by braces, as shown below with $n \geq 0$ statements:

```
{
    <statement 1>
    <statement 2>
    ...
    <statement n>
}
```

If multiple statements are needed in the <then block> or the <else block>, they must be surrounded by braces { and }. For example, suppose we want to print out additional messages for each case. Let's say we also want to print Keep up the good work when the student passes and print Try harder next time when the student does not pass. Here's how:

```

if (testScore < 70)
{
    System.out.println("You did not pass");
    System.out.println("Try harder next time");
}
else
{
    System.out.println("You did pass");
    System.out.println("Keep up the good work");
}

```

The diagram shows an if-else statement. The 'if' block contains two lines of code: `System.out.println("You did not pass");` and `System.out.println("Try harder next time");`. The 'else' block contains two lines of code: `System.out.println("You did pass");` and `System.out.println("Keep up the good work");`. Both blocks are enclosed in curly braces. A label 'Compound Statements' on the left has two arrows pointing to the two blocks.

The braces are necessary to delineate the statements inside the block. Without the braces, the compiler will not be able to tell whether a statement is part of the block or part of the statement that follows the if statement.

Notice the absence of semicolons after the right braces. A semicolon is never necessary immediately after a right brace. A compound statement may contain zero

or more statements, so it is perfectly valid for a compound statement to include only one statement. Indeed, we can write the sample if statement as

```

if (testScore < 70)
{
    System.out.println("You did not pass");
}

else

{
    System.out.println("You did pass");
}

```

Although it is not required, many programmers prefer to use the syntax for the compound statement even if the then or else block includes only one statement. In this textbook, we use the syntax for the compound statement regardless of the number of statements inside the then and else blocks. Following this policy is beneficial for a number of reasons. One is the ease of adding temporary output statements inside the blocks. Frequently, we want to include a temporary output statement to verify that the boolean expression is written correctly. Suppose we add output statements such as these:

```

if (testScore < 70)
{
    System.out.println("inside then: " + testScore);
    System.out.println("You did not pass");
}
else
{
    System.out.println("inside else: " + testScore);
    System.out.println("You did pass");
}

```

If we always use the syntax for the compound statement, we just add and delete the temporary output statements. However, if we use the syntax of the single statement, then we have to remember to add the braces when we want to include a temporary output statement. Another reason for using the compound statement syntax exclusively is to avoid the dangling else problem. We discuss this problem in Section 5.2.

The placement of left and right braces does not matter to the compiler. The compiler will not complain if you write the earlier if statement as

```

if (testScore < 70)
{ System.out.println("You did not pass");
  System.out.println("Try harder next time");} else
{
  System.out.println("You did pass");
  System.out.println("Keep up the good work");}

```

However, to keep your code readable and easy to follow, you should format your if statements using one of the two most common styles:

Style 1

```
if ( <boolean expression> ) {
    ...
} else {
    ...
}
```

Style 2

```
if ( <boolean expression> )
{
    ...
}
else
{
    ...
}
```

In this book, we will use style 1, mainly because this style adheres to the code conventions for the Java programming language. If you prefer style 2, then go ahead and use it. Whichever style you choose, be consistent, because a consistent look and feel is very important to make your code readable.



The document that provides the details of code conventions for Java can be found at <http://java.sun.com/docs/codeconv/html/CodeConvTOC.doc.html>

This document describes the Java language coding standards dictated in the Java Language Specification. It is important to follow the code conventions as closely as possible to increase the readability of the software.

There is a second variation of style 1 in which we place the reserved word else on a new line as

Style 3

```
if ( <boolean expression> ) {
    ...
}
else {
    ...
}
```

Many programmers prefer this variation of style 1 because the reserved word else aligns with the matching if. However, if we nitpick, style 3 goes against the logic behind the recommended style 1 format, which is to begin a new statement at one position with a reserved word. The reserved word else is a part of the if statement, not the beginning of a new statement. Thus style 1 places the reserved word else to the right of the matching if.

Again, the actual format is not that important. Consistent use of the same format is. So, whichever style you use, use it consistently. To promote consistency among all programmers, we recommend that everybody to adopt the code conventions. Even though the recommended format may look peculiar at first, with some repeated use, the format becomes natural in no time.

Let's summarize the key points to remember:

Things to Remember



Rules for writing the **then** and **else** blocks:

1. Left and right braces are necessary to surround the statements if the **then** or **else** block contains multiple statements.
2. Braces are not necessary if the **then** or **else** block contains only one statement.
3. A semicolon is not necessary after a right brace.

Now let's study a second version of the if statement called *if-then*. Suppose we want to print out the message You are an honor student if the test score is 95 or above and print out nothing otherwise. For this type of testing, we use the second version of the if statement, whose general format is

if-then syntax

```
if ( <boolean expression> )
    <then block>
```

The second version contains only the <then block>. Using this version and the compound statement syntax, we express the selection control as

```
if (testScore >= 95) {
    System.out.println("You are an honor student");
}
```

Figure 5.3 shows the diagram that illustrates the control flow for this if-then statement. We will refer collectively to both versions as the *if* statement.

Notice that the if-then statement is not necessary, because we can write any if-then statement using if-then-else by including no statement in the else block. For instance, the sample if-then statement can be written as

```
if (testScore >= 95) {
    System.out.println("You are an honor student");
} else { }
```

In this book, we use if-then statements whenever appropriate.

Let's conclude this section with a sample class that models a circle. We will name the class Ch5Circle, and its instances are capable of computing the

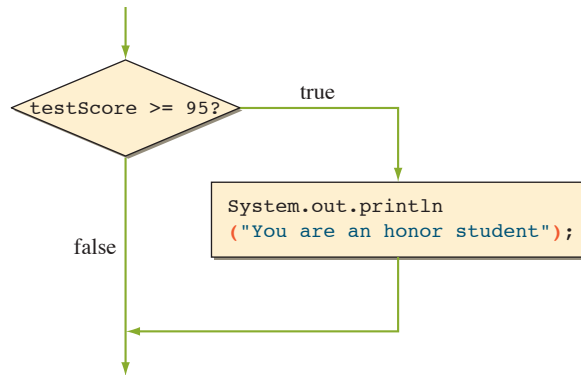

Figure 5.3 The diagram showing the control flow of the second version of the **if** statement.

circumference and area. We will include a test in this class so the methods such as `getArea` and `getCircumference` return the constant `INVALID_DIMENSION` when the dimension of the radius is invalid. Here's the `Ch5Circle` class (most comments are removed for the sake of brevity):

```

/*
  Chapter 5 The Circle class
  File: Ch5Circle.java
*/
class Ch5Circle {
    public static final int INVALID_DIMENSION = -1;
    private double radius;

    public Ch5Circle(double r) {
        setRadius(r);
    }

    public double getArea( ) {
        double result = INVALID_DIMENSION;

        if (isRadiusValid()) {
            result = Math.PI * radius * radius;
        }

        return result;
    }
}

```

As the number of methods gets larger, we will use this marker to quickly locate the program components. Shaded icon is used for a private element.

Data Members

getArea

```
public double getCircumference( ) {  
    double result = INVALID_DIMENSION;  
    if (isRadiusValid()) {  
        result = 2.0 * Math.PI * radius;  
    }  
    return result;  
}  
  
public double getDiameter( ) {  
    double diameter = INVALID_DIMENSION;  
    if (isRadiusValid()) {  
        diameter = 2.0 * radius;  
    }  
    return diameter;  
}  
  
public double getRadius( ) {  
    return radius;  
}  
  
public void setDiameter(double d) {  
    if (d > 0) {  
        setRadius(d/2.0);  
    } else {  
        setRadius(INVALID_DIMENSION);  
    }  
}  
  
public void setRadius(double r) {  
    if (r > 0) {  
        radius = r;  
    } else {  
        radius = INVALID_DIMENSION;  
    }  
}  
  
private boolean isRadiusValid( ) {  
    return radius != INVALID_DIMENSION;  
}  
}
```

getCircumference

getDiameter

getRadius

setDiameter

setRadius

isRadiusValid

Notice the if statement in the getArea method is written as

```

    if (isRadiusValid()) {
        ...
    }

```

The <boolean expression> in the if statement can be any expression that evaluates to true or false, including a call to a method whose return type is boolean, such as the isRadiusValid method. The use of such a boolean method often makes the code easier to read, and easier to modify if the boolean method is called from many methods (e.g., there are three methods calling the isRadiusValid method).

Here's a short main class to test the functionality of the Ch5Circle class:

```

/*
   Chapter 5 Sample Program: Computing Circle Dimensions
   File: Ch5Sample1.java
*/

import java.util.*;

class Ch5Sample1 {

    public static void main(String[] args) {

        double    radius, circumference, area;

        Ch5Circle circle;

        Scanner scanner = new Scanner(System.in);

        System.out.print("Enter radius: ");
        radius = scanner.nextDouble();

        circle = new Ch5Circle(radius);

        circumference = circle.getCircumference();

        area          = circle.getArea();

        System.out.println("Input radius:  " + radius);
        System.out.println("Circumference: " + circumference);
        System.out.println("Area:         " + area);

    }
}

```

Notice that the program will display -1.0 when the input radius is invalid. We can improve the display by adding an if test in the main program as follows:

```
System.out.print("Circumference: ");
if (circumference == Ch5Circle.INVALID_DIMENSION) {
    System.out.println("Cannot compute. Input invalid");
} else {
    System.out.println(circumference);
}
```

Another possible improvement in the main program is to check the input value first. For instance,

```
radius = ... ;
if (radius > 0) {
    //do the computation as the sample main method
} else {
    //print out the error message
}
```

Even when a client programmer does not include appropriate tests in his program, we must define a reusable class in a robust manner so it will not crash or produce erroneous results. For the Ch5Circle class, we add a test so the data member radius is set to either a valid datum or a specially designated value (INVALID_DIMENSION) for any invalid data. By designing the class in this manner, we protect the class from a possible misuse (e.g., attempting to assign a negative radius) and producing meaningless results, such as -5.88 . We always strive for a reliable and robust reusable class that will withstand the abuse and misuse of client programmers.



1. Identify the invalid if statements:

a. **if** (a < b) then
 x = y;
else
 x = z;

b. **if** (a < b)
 else x = y;

c. **if** (a < b)
 x = y;
 else {
 x = z;
 };

d. **if** (a < b) {
 x = y; } **else**
 x = z;

2. Are the following two if statements equivalent?

```
/*A*/ if ( x < y )
    System.out.println("Hello");
else
    System.out.println("Bye");
```

```
/*B*/ if ( x > y )
    System.out.println("Bye");
else
    System.out.println("Hello");
```

5.2 | Nested if Statements

nested if
statement

The then and else blocks of an if statement can contain any statement including another if statement. An if statement that contains another if statement in either its then or else block is called a *nested if* statement. Let's look at an example. In the earlier example, we printed out the messages You did pass or You did not pass depending on the test score. Let's modify the code to print out three possible messages. If the test score is lower than 70, then we print You did not pass, as before. If the test score is 70 or higher, then we will check the student's age. If the age is less than 10, we will print You did a great job. Otherwise, we will print You did pass, as before. Figure 5.4 is a diagram showing the logic of this nested test. The code is written as follows:

```
if (testScore >= 70) {
    if (studentAge < 10) {
        System.out.println("You did a great job");
    } else {
        System.out.println("You did pass");//test score >= 70
                                                //and age >= 10
    }
} else { //test score < 70
    System.out.println("You did not pass");
}
```

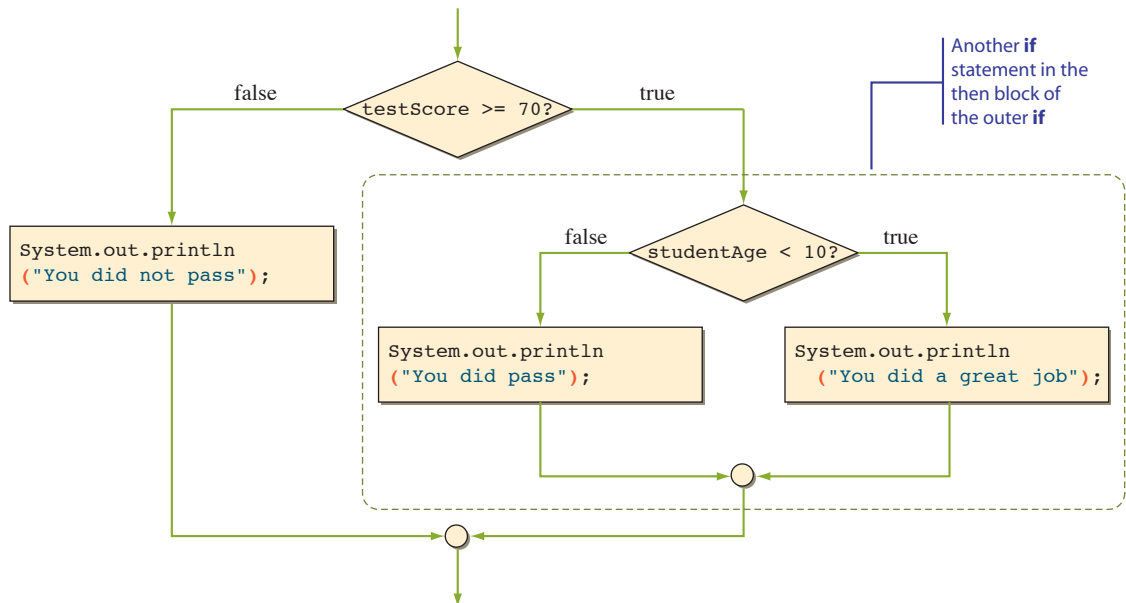

Figure 5.4 A diagram showing the control flow of the example nested if statement.

Since the then block of the outer if contains another if statement, the outer if is called a nested if statement. It is possible to write if tests in different ways to achieve the same result. For example, the preceding code can also be expressed as

```

if (testScore >= 70 && studentAge < 10) {
    System.out.println("You did a great job");
} else {
    //either testScore < 70 OR studentAge >= 10

    if (testScore >= 70) {
        System.out.println("You did pass");
    } else {
        System.out.println("You did not pass");
    }
}

```

Several other variations can also achieve the same result. As a general rule, we strive to select the one that is most readable (i.e., most easily understood) and most efficient. Often no one variation stands out, and the one you choose depends on your preferred style of programming.

Here's an example in which one variation is clearly a better choice. Suppose we input three integers and determine how many of them are negative. Here's the first variation. To show the structure more clearly, we purposely do not use the braces in the then and else blocks.

In this and the following examples, we purposely do not use the braces so we can provide a better illustration of the topics we are presenting.

```

if (num1 < 0)
    if (num2 < 0)
        if (num3 < 0)
            negativeCount = 3; //all three are negative
        else
            negativeCount = 2; //num1 and num2 are negative
    else
        if (num3 < 0)
            negativeCount = 2; //num1 and num3 are negative
        else
            negativeCount = 1; //num1 is negative
else
    if (num2 < 0)
        if (num3 < 0)
            negativeCount = 2; //num2 and num3 are negative
        else
            negativeCount = 1; //num2 is negative
    else
        if (num3 < 0)
            negativeCount = 1; //num3 is negative
        else
            negativeCount = 0; //no negative numbers

```

It certainly did the job. But elegantly? Here's the second variation:

```
negativeCount = 0;
if (num1 < 0)
    negativeCount = negativeCount + 1;
if (num2 < 0)
    negativeCount = negativeCount + 1;
if (num3 < 0)
    negativeCount = negativeCount + 1;
```

Which version should we use? The second variation is the only reasonable way to go. The first variation is not a viable option because it is very inefficient and very difficult to read. We apply the nested if structure if we have to test conditions in some required order. In this example these three tests are independent of one another, so they can be executed in any order. In other words, it doesn't matter whether we test num1 first or last.

The statement

```
negativeCount = negativeCount + 1;
```

increments the variable by 1. This type of statement that changes the value of a variable by adding a fixed number occurs frequently in programs. Instead of repeating the same variable name twice, we can write it succinctly as

```
negativeCount++;
```

Similarly, a statement such as

```
count = count - 1;
```

can be written as

```
count--;
```

increment and
decrement
operators

The double plus operator (`++`) is called the *increment operator*, and the double minus operator (`--`) is the *decrement operator* (which decrements the variable by 1). The increment and decrement operators have higher precedence than unary operators. See Table 5.3 on page 243. *Note:* There are prefix and postfix increment/decrement operators in which the operators come before and after the variable (or an expression), respectively. We only use the postfix operators in this book, and the precedence rules presented in the table apply to the postfix operators only.

Notice that we indent the then and else blocks to show the nested structure clearly. Indentation is used as a visual guide for the readers. It makes no difference to a Java compiler. For example, we make our intent clear by writing the statement as

```
if (x < y)
    if (z != w)
        a = b + 1;
    else
        a = c + 1;
else
    a = b * c;
```

Hints,
& Tips,
Pitfalls

It takes some practice before you can write well-formed **if** statements. Here are some rules to help you write the **if** statements.

- Rule 1:** Minimize the number of nestings.
- Rule 2:** Avoid complex boolean expressions. Make them as simple as possible. Don't include many ANDs and ORs.
- Rule 3:** Eliminate any unnecessary comparisons.
- Rule 4:** Don't be satisfied with the first correct statement. Always look for improvement.
- Rule 5:** Read your code again. Can you follow the statement easily? If not, try to improve it.

But to the Java compiler, it does not matter if we write the same code as

```
if (x < y)if (z != w)a = b + 1;else a = c + 1; else a = b * c;
```

Although indentation is not required to run the program, using proper indentation is an important aspect of good programming style. Since the goal is to make your code readable, not to follow any one style of indentation, you are free to choose your own style. We recommend style 1 shown on page 227.

The next example shows a style of indentation accepted as standard for a nested if statement in which nesting occurs only in the else block. Instead of determining whether a student passes or not, we will now display a letter grade based on the following formula:

Test Score	Grade
$90 \leq \text{score}$	A
$80 \leq \text{score} < 90$	B
$70 \leq \text{score} < 80$	C
$60 \leq \text{score} < 70$	D
$\text{score} < 60$	F

The statement can be written as

```
if (score >= 90)
    System.out.println("Your grade is A");
else
    if (score >= 80)
        System.out.println("Your grade is B");
    else
        if (score >= 70)
            System.out.println("Your grade is C");
```

```

else
    if (score >= 60)
        System.out.println("Your grade is D");
    else
        System.out.println("Your grade is F");

```

However, the standard way to indent the statement is as follows:

```

if (score >= 90)
    System.out.println("Your grade is A");

else if (score >= 80)
    System.out.println("Your grade is B");

else if (score >= 70)
    System.out.println("Your grade is C");

else if (score >= 60)
    System.out.println("Your grade is D");

else
    System.out.println("Your grade is F");

```

We mentioned that indentation is meant for human eyes only. For example, we can clearly see the intent of a programmer just by looking at the indentation when we read

```

if (x < y)
    if (x < z)
        System.out.println("Hello");
else
    System.out.println("Good bye");

```

Indentation style A

A Java compiler, however, will interpret the above as

```

if (x < y)
    if (x < z)
        System.out.println("Hello");
else
    System.out.println("Good bye");

```

Indentation style B

dangling else
problem

This example has a *dangling else problem*. The Java compiler matches an else with the previous unmatched if, so the compiler will interpret the statement by matching the else with the inner if (if (x < z)), whether you use indentation style A or B. If you want to express the logic of indentation style A, you have to express it as

```

if (x < y) {
    if (x < z)
        System.out.println("Hello");
} else
    System.out.println("Good bye");

```

This dangling else problem is another reason why we recommend that beginners use the syntax for <compound statement> in the then and else blocks. In other words, always use the braces in the then and else blocks.

Let's conclude this section by including tests inside the add and deduct methods of the Account class from Chapter 4. For both methods, we will update the balance only when the amount passed is positive. Furthermore, for the deduct method, we will update the balance only if it does not become a negative number after the deduction. This will require the use of a nested if statement. The following is the class declaration. The name is Ch5Account, and this class is based on AccountVer2 from Chapter 4. We only list the two methods here because other parts are the same as in AccountVer2.

```
class Ch5Account {
    ...
    //Adds the passed amount to the balance
    public void add(double amt) {
        //add if amt is positive; otherwise, do nothing
        if (amt > 0) {
            balance = balance + amt;
        }
    }
    //Deducts the passed amount from the balance
    public void deduct(double amt) {
        //deduct if amt is positive; do nothing otherwise
        if (amt > 0) {
            double newbalance = balance - amt;
            if (newbalance >= 0) { //if a new balance is positive, then
                balance = newbalance; //update the balance; otherwise,
            } //do nothing.
        }
    }
    ...
}
```

add

deduct



1. Rewrite the following nested if statements without using any nesting.

```
a. if ( a < c )
    if ( b < c )
        x = y;
    else
        x = z;
```

```

else
    x = z;
b. if ( a == b )
    x = y;
else
    if ( a > b )
        x = y;
    else
        x = z;
c. if ( a < b )
    if ( a >= b )
        x = z;
    else
        x = y;
else
    x = z;

```

2. Format the following if statements with indentation.

```

a. if ( a < b ) if ( c > d ) x = y;
   else x = z;
b. if ( a < b ) { if ( c > d ) x = y; }
   else x = z;
c. if ( a < b ) x = y; if ( a < c ) x = z;
   else if ( c < d ) z = y;

```

5.3 Boolean Expressions and Variables

boolean
operator

In addition to the arithmetic operators introduced in Chapter 3 and relational operators introduced in Section 5.2, boolean expressions can contain conditional and boolean operators. A *boolean operator*, also called a *logical operator*, takes boolean values as its operands and returns a boolean value. Three boolean operators are AND, OR, and NOT. In Java, the symbols `&&`, `||`, and `!` represent the AND, OR, and NOT operators, respectively. Table 5.1 explains how these operators work.

The AND operation results in true only if both P and Q are true. The OR operation results in true if either P or Q is true. The NOT operation is true if A is false and is false if P is true. Combining boolean operators with relational and arithmetic operators, we can come up with long boolean expressions such as

```

(x + 150) == y || x < y && !(y < z && z < x)
(x < y) && (a == b || a == c)
a != 0 && b != 0 && (a + b < 10)

```

In Section 5.1 we stated that we can reverse the relational operator and switch the then and else blocks to derive the equivalent code. For example,

```

if (age < 0) {
    System.out.println("Invalid age is entered");
} else {
    System.out.println("Valid age is entered");
}

```

Table 5.1 Boolean operators and their meanings

P	Q	P && Q	P Q	!P
false	false	false	false	true
false	true	false	true	true
true	false	false	true	false
true	true	true	true	false

is equivalent to

```
if ( !(age < 0) ) {
    System.out.println("Valid age is entered");
} else {
    System.out.println("Invalid age is entered");
}
```

which can be written more naturally as

```
if (age >= 0) {
    System.out.println("Valid age is entered");
} else {
    System.out.println("Invalid age is entered");
}
```

Reversing the relational operator means negating the boolean expression. In other words, `!(age < 0)` is equivalent to `(age >= 0)`. Now, consider the following if-then-else statement:

```
if (temperature >= 65 && distanceToDestination < 2) {
    System.out.println("Let's walk");
} else {
    System.out.println("Let's drive");
}
```

If the temperature is greater than or equal to 65 degrees and the distance to the destination is less than 2 mi., we walk. Otherwise (it's too cold or too far away), we drive. How do we reverse the if-then-else statement? We can rewrite the statement by negating the boolean expression and switching the then and else blocks as

```
if ( !(temperature >= 65 && distanceToDestination < 2) ) {
    System.out.println("Let's drive");
} else {
    System.out.println("Let's walk");
}
```

or more directly and naturally as

```
if (temperature < 65 || distanceToDestination >= 2) {
    System.out.println("Let's drive");
} else {
    System.out.println("Let's walk");
}
```

The expression

```
!(temperature >= 65 && distanceToDestination < 2)
```

is equivalent to

```
!(temperature >= 65) || !(distanceToDestination < 2)
```

which, in turn, is equivalent to

```
(temperature < 65 || distanceToDestination >= 2)
```

The logical equivalence is derived by applying the following DeMorgan's law:

Rule 1: $!(P \ \&\& \ Q) \iff !P \ || \ !Q$

Rule 2: $!(P \ || \ Q) \iff !P \ \&\& \ !Q$

Equivalence symbol

Table 5.2 shows their equivalence.

Now consider the following expression:

```
x / y > z || y == 0
```

arithmetic
exception

What will be the result if y is equal to 0? Easy, the result is true, many of you might say. Actually a runtime error called an *arithmetic exception* will result, because the expression

```
x / y
```

Table 5.2 The truth table illustrating DeMorgan's law

P	Q	!(P && Q)	!P !Q	!(P Q)	!P && !Q
false	false	true	true	true	true
false	true	true	true	false	false
true	false	true	true	false	false
true	true	false	false	false	false

divide-by-zero
error

causes a problem known as a *divide-by-zero error*. Remember that you cannot divide a number by zero.

However, if we reverse the order to

```
y == 0 || x / y > z
```

then no arithmetic exception will occur because the test $x / y > z$ will not be evaluated. For the OR operator `||`, if the left operand is evaluated to true, then the right operand will not be evaluated, because the whole expression is true, whether the value of the right operand is true or false. We call such an evaluation method a *short-circuit evaluation*. For the AND operator `&&`, the right operand need not be evaluated if the left operand is evaluated to false, because the result will then be false whether the value of the right operand is true or false.

short-circuit
evaluation

Just as the operator precedence rules are necessary to evaluate arithmetic expressions unambiguously, they are required for evaluating boolean expressions. Table 5.3 expands Table 3.3 by including all operators introduced so far.

In mathematics, we specify the range of values for a variable as

$$80 \leq x < 90$$

In Java, to test that the value for x is within the specified lower and upper bounds, we express it as

```
80 <= x && x < 90
```

You cannot specify it as

```
80 <= x < 90
```



This is a syntax error because the relational operators (`<`, `<=`, etc.) are binary operators whose operands must be numerical values. Notice that the result of the subexpression

```
80 <= x
```

is a boolean value, which cannot be compared to the numerical value 90. Their data types are not compatible.

The result of a boolean expression is either true or false, which are the two values of data type `boolean`. As is the case with other data types, a value of a data type can be assigned to a variable of the same data type. In other words, we can declare a variable of data type `boolean` and assign a boolean value to it. Here are examples:

```
boolean pass, done;

pass = 70 < x;
done = true;
```

One possible use of boolean variables is to keep track of the program settings or user preferences. A variable (of any data type, not just `boolean`) used for this

Table 5.3

Operator precedence rules. Groups are listed in descending order of precedence. An operator with a higher precedence will be evaluated first. If two operators have the same precedence, then the associativity rule is applied

Group	Operator	Precedence	Associativity
Subexpression	()	10 (If parentheses are nested, then innermost subexpression is evaluated first.)	Left to right
Postfix increment and decrement operators	++ --	9	Right to left
Unary operators	- !	8	Right to left
Multiplicative operators	* / %	7	Left to right
Additive operators	+ -	6	Left to right
Relational operators	< <= > >=	5	Left to right
Equality operators	== !=	4	Left to right
Boolean AND	&&	3	Left to right
Boolean OR		2	Left to right
Assignment	=	1	Right to left

flag

purpose is called a *flag*. Suppose we want to allow the user to display either short or long messages. Many people, when using a new program, prefer to see long messages, such as Enter a person's age and press the Enter key to continue. But once they are familiar with the program, many users prefer to see short messages, such as Enter age. We can use a boolean flag to remember the user's preference. We can set the flag `longMessageFormat` at the beginning of the program to true or false depending on the user's choice. Once this boolean flag is set, we can refer to the flag at different points in the program as follows:

```
if (longMessageFormat) {
    //display the message in long format
}
```



```

    } else {
        //display the message in short format
    }

```

Notice the value of a boolean variable is true or false, so even though it is valid, we do not write a boolean expression as

```

if (isRaining == true) {
    System.out.println("Store is open");
} else {
    System.out.println("Store is closed");
}

```

but more succinctly as

```

if (isRaining) {
    System.out.println("Store is open");
} else {
    System.out.println("Store is closed");
}

```

Another point that we have to be careful about in using boolean variables is the choice of identifier. Instead of using a boolean variable such as motionStatus, it is more meaningful and descriptive to use the variable isMoving. For example, the statement

```

if (isMoving) {
    //the mobile robot is moving
} else {
    //the mobile robot is not moving
}

```

is much clearer than the statement

```

if (motionStatus) {
    //the mobile robot is moving
} else {
    //the mobile robot is not moving
}

```

When we define a boolean data member for a class, it is a Java convention to use the prefix is instead of get for the accessor.

We again conclude the section with a sample class. Let's improve the Ch5Account class by adding a boolean data member active to represent the state of an account. When an account is first open, it is set to an active state. Deposits and

withdrawals can be made only when the account is active. If the account is inactive, then the requested operation is ignored. Here's how the class is defined (the actual class name is Ch5AccountVer2):

```

class Ch5AccountVer2 {

    // Data Members
    private String ownerName;

    private double balance;

    private boolean active;

    //Constructor
    public Ch5AccountVer2(String name, double startingBalance ) {

        ownerName = name;
        balance = startingBalance;

        setActive(true);
    }

    //Adds the passed amount to the balance
    public void add(double amt) {
        //add if amt is positive; do nothing otherwise
        if (isActive() && amt > 0) {
            balance = balance + amt;
        }
    }

    //Closes the account; set 'active' to false
    public void close( ) {

        setActive(false);
    }

    //Deducts the passed amount from the balance
    public void deduct(double amt) {

        //deduct if amt is positive; do nothing otherwise
        if (isActive() && amt > 0) {
            double newbalance = balance - amt;

            if (newbalance >= 0) { //don't let the balance become negative
                balance = newbalance;
            }
        }
    }
}

```

Data Members

add

close

deduct

<code>//Returns the current balance of this account public double getCurrentBalance() { return balance; }</code>	getCurrentBalance
<code>//Returns the name of this account's owner public String getOwnerName() { return ownerName; }</code>	getOwnerName
<code>//Is the account active? public boolean isActive() { return active; }</code>	isActive
<code>//Assigns the name of this account's owner public void setOwnerName(String name) { ownerName = name; }</code>	setOwnerName
<code>//Sets 'active' to true or false private void setActive(boolean state) { active = state; }</code>	setActive

Quick CHECK

- Evaluate the following boolean expressions. Assume x, y, and z have some numerical values.
 - `4 < 5 || 6 == 6`
 - `2 < 4 && (false || 5 <= 4)`
 - `x <= y && !(z != z) || x > y`
 - `x < y || z < y && y <= z`
- Identify errors in the following boolean expressions and assignments. Assume x and y have some numerical values.
 - `boolean done;
done = x = y;`
 - `2 < 4 && (3 < 5) + 1 == 3`
 - `boolean quit;
quit = true;
quit == (34 == 20) && quit;`

Hints, & Tips, Pitfalls



We introduced the logical AND and OR operations using the symbols `&&` and `||`. In Java, there are single ampersand and single vertical bar operations. For example, if we write an `if` statement as

```
if ( 70 <= x & x < 90 )
```

it will compile and run. Unlike the double ampersand, the single ampersand will not do a short-circuit evaluation. It will evaluate both left and right operands. The single vertical bar works in an analogous manner. So, which one should we use? Use double ampersand for AND and double vertical bars for OR. We will most likely never encounter a situation where we cannot use the double ampersand or the double vertical bars.

5.4 | Comparing Objects

With primitive data types, we have only one way to compare them, but with objects (reference data type), we have two ways to compare them. We discuss the ways the objects can be compared in this section. First, let's review how we compare primitive data types. What would be the output of the following code?

```
int num1, num2;

num1 = 15;
num2 = 15;

if (num1 == num2) {
    System.out.println("They are equal");
} else {
    System.out.println("They are not equal");
}
```

Because the two variables hold the same value, the output is

```
They are equal
```

Now, let's see how the objects can be compared. We will use `String` objects for illustration. Since we use string data all the time in our programs, it is very important for us to understand perfectly how `String` objects can be compared.

Consider the following code that attempts to compare two `String` objects:

```
String str1, str2;

str1 = new String("Java");
str2 = new String("Java");

if (str1 == str2) {
    System.out.println("They are equal");
}
```

```

    } else {
        System.out.println("They are not equal");
    }
}

```

What would be an output? The answer is

```
They are not equal
```

The two objects are constructed with the same sequence of characters, but the result of comparison came back that they were not equal. Why?

When two variables are compared, we are comparing their contents. In the case of primitive data types, the content is the actual value. In case of reference data types, the content is the address where the object is stored. Since there are two distinct String objects, stored at different addresses, the contents of `str1` and `str2` are different, and therefore, the equality testing results in false. If we change the code to

```

String str1, str2;

str1 = new String("Java");
str2 = str1;

if (str1 == str2) {
    System.out.println("They are equal");
} else {
    System.out.println("They are not equal");
}

```

No new object is created here. The content (address) of `str1` is copied to `str2`, making them both point to the same object.

then the output would be

```
They are equal
```

because now we have one String object and both variables `str1` and `str2` point to this object. This means the contents of `str1` and `str2` are the same because they refer to the same address. Figure 5.5 shows the distinction.

What can we do if we need to check whether two distinct String objects have the same sequence of characters? Many standard classes include different types of comparison methods. The String class, for example, includes the `equals` and `equalsIgnoreCase` comparison methods. The `equals` method returns true if two String objects have the exact same sequence of characters. The `equalsIgnoreCase` method does the same as the `equals` method, but the comparison is done in a case-insensitive manner. Using the `equals` method, we can rewrite the first sample code as

```

String str1, str2;

str1 = new String("Java");
str2 = new String("Java");

if (str1.equals(str2)) {
    System.out.println("They are equal");
} else {
    System.out.println("They are not equal");
}

```

Use the `equals` method.

Case A: Two variables refer to two different objects.

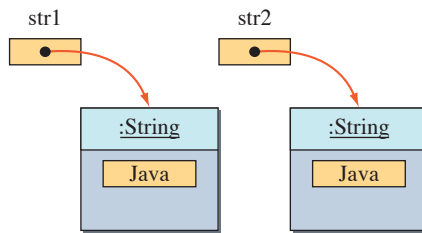

```
String str1, str2;

str1 = new String("Java");
str2 = new String("Java");
```

str1 == str2 → false

Case B: Two variables refer to the same object.

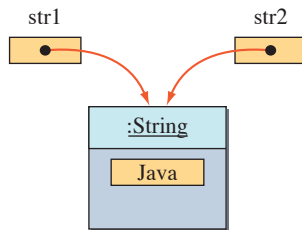

```
String str1, str2;

str1 = new String("Java");
str2 = str1;
```

str1 == str2 → true

Figure 5.5 How the equality == testing works with the objects.

and get the result

They are equal

Just as the String and many standard classes provide the equals method, it is common to include such an equals method in programmer-defined classes also. Consider a Fraction class. We say two Fraction objects are equal if they have the same value for the numerator and the denominator. Here's how we can define the equals method for the Fraction class:

```
class Fraction {

    private int numerator;

    private int denominator;

    ...

    //constructor and other methods

    ...

    public int getNumerator( ) {
        return numerator;
    }
}
```

```

public int getDenominator( ) {
    return denominator;
}

public boolean equals(Fraction number) {
    return (numerator == number.getNumerator()
        && denominator == number.getDenominator());
}

```

Compare this object's values to the values of **number**

Notice that the body of the equals method is a concise version of

```

if (numerator == number.getNumerator( )
    && denominator == number.getDenominator()) {

    return true;

} else {

    return false;

}

```

Using the equals method, we can compare two Fraction objects in the following manner:

```

Fraction frac1, frac2;

//create frac1 and frac2 objects
...

if (frac1.equals(frac2)) {
    ...
}

```

or equivalently as

```

if (frac2.equals(frac1)) {
    ...
}

```

Note that the equals method as defined is incomplete. For example, if we compare fractions $4/8$ and $3/6$, using this equals method, we get false as the result because the method does not compare the fractions in their simplified form. The method should have reduced both $4/8$ and $3/6$ to $1/2$ and then compared. To implement a method that reduces a fraction to its simplest form, we need to use a repetition control statement. We will revisit this problem when we learn how to write repetition control statements in Chapter 6. Also, we will provide the complete definition of the Fraction class in Chapter 7.

We conclude this section by presenting an exception to the rule for comparing objects. This exception applies to the String class only. We already mentioned in

Chapter 2 that for the `String` class only, we do not have to use the `new` operator to create an instance. In other words, instead of writing

```
String str = new String("Java");
```

we can write

```
String str = "Java";
```

which is a more common form. These two statements are not identical in terms of memory allocation, which in turn affects how the string comparisons work. Figure 5.6 shows the difference in assigning a `String` object to a variable. If we do not use the `new` operator, then string data are treated as if they are a primitive data type. When we use the same literal `String` constants in a program, there will be exactly one `String` object.

This means we can use the equal symbol `==` to compare `String` objects when no `new` operators are used. However, regardless of how the `String` objects are created, it is always correct and safe to use the `equals` and other comparison methods to compare two strings.

Things to Remember



Always use the **equals** and other comparison methods to compare **String** objects. Do not use `==` even though it may work correctly in certain cases.

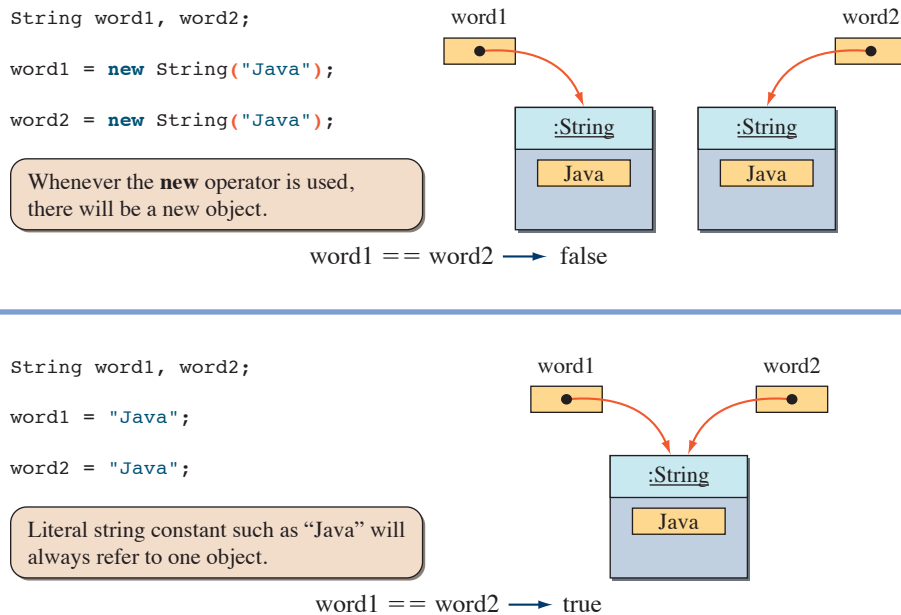

Figure 5.6 Difference between using and not using the `new` operator for `String`.



1. Determine the output of the following code.

```
String str1 = "Java";
String str2 = "Java";

boolean result1 = str1 == str2;
boolean result2 = str1.equals(str2);

System.out.println(result1);
System.out.println(result2);
```

2. Determine the output of the following code.

```
String str1 = new String("latte");
String str2 = new String("LATTE");

boolean result1 = str1 == str2;
boolean result2 = str1.equals(str2);

System.out.println(result1);
System.out.println(result2);
```

3. Show the state of memory after the following statements are executed.

```
String str1, str2, str3;
str1 = "Jasmine";
str2 = "Oolong";
str3 = str2;
str2 = str1;
```

5.5 The switch Statement

switch
statement

Another Java statement that implements a selection control flow is the *switch statement*. Suppose we want to direct the students to the designated location for them to register for classes. The location where they register is determined by their grade level. The user enters 1 for freshman, 2 for sophomore, 3 for junior, and 4 for senior. Using the switch statement, we can write the code as

```
int gradeLevel;

Scanner scanner = new Scanner(System.in);

System.out.print("Grade (Frosh-1,Soph-2,...): ");

gradeLevel = scanner.nextInt();

switch (gradeLevel) {

    case 1: System.out.println("Go to the Gymnasium");
            break;

    case 2: System.out.println("Go to the Science Auditorium");
            break;
```

```

    case 3: System.out.println("Go to Halligan Hall Rm 104");
            break;

    case 4: System.out.println("Go to Root Hall Rm 101");
            break;
}

```

The syntax for the `switch` statement is

switch
statement
syntax

```

switch ( <integer expression> ) {
    <case label 1> : <case body 1>
    ...
    <case label n> : <case body n>
}

```

Figure 5.7 illustrates the correspondence between the `switch` statement we wrote and the general format.

The `<case label i>` has the form

default
reserved word

```

case <integer constant> or default

```

and `<case body i>` is a sequence of zero or more statements. Notice that `<case body i>` is not surrounded by left and right braces. The `<constant>` can be either a named or literal constant.

The data type of `<arithmetic expression>` must be `char`, `byte`, `short`, or `int`. (*Note:* We will cover the data type `char` in Chap. 9.) The value of `<arithmetic expression>` is compared against the constant value `i` of `<case label i>`. If there is a

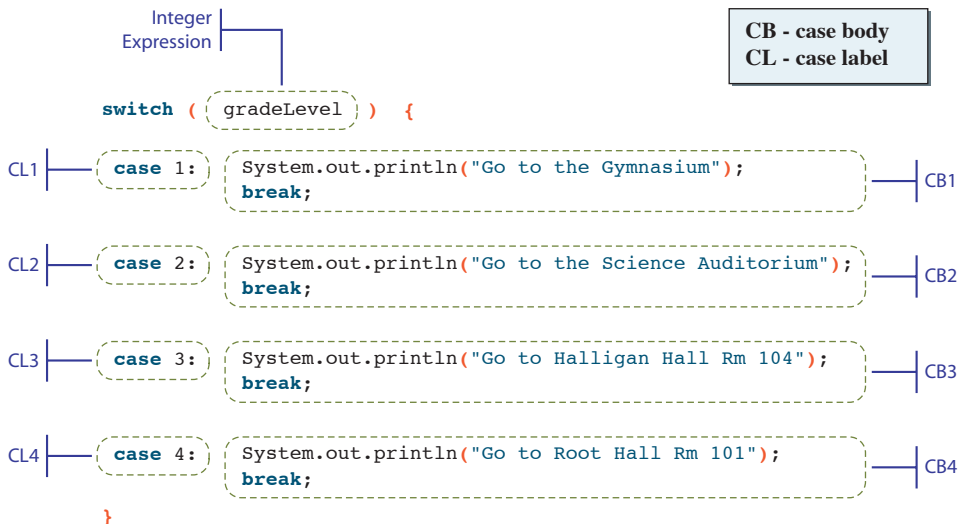

Figure 5.7 Mapping of the sample `switch` statement to the general format.

matching case, then its case body is executed. If there is no matching case, then the execution continues to the statement that follows the switch statement. No two cases are allowed to have the same value for <constant>, and the cases can be listed in any order.

**break
statement**

Notice that each case in the sample switch statement is terminated with the **break statement**. The break statement causes execution to continue from the statement following this switch statement, skipping the remaining portion of the switch statement. The following example illustrates how the break statement works:

```
//Assume necessary declaration and object creation are done
selection = 1;

switch (selection) {
    case 0: System.out.println(0);
    case 1: System.out.println(1);
    case 2: System.out.println(2);
    case 3: System.out.println(3);
}
```

When this code is executed, the output is

```
1
2
3
```

because after the statement in case 1 is executed, statements in the remaining cases will be executed also. To execute statements in one and only one case, we need to include the break statement at the end of each case, as we have done in the first example. Figure 5.8 shows the effect of the break statement.

The break statement is not necessary in the last case, but for consistency we place it in every case. Also, by doing so we don't have to remember to include the break statement in the last case when we add more cases to the end of the switch statement.

Individual cases do not have to include a statement, so we can write something like this:

```
Scanner scanner = new Scanner(System.in);
System.out.print("Input: ");
int ranking = scanner.nextInt();

switch (ranking) {
    case 10:
    case 9:
    case 8: System.out.println("Master");
            break;
    case 7:
    case 6: System.out.println("Journeyman");
            break;
```

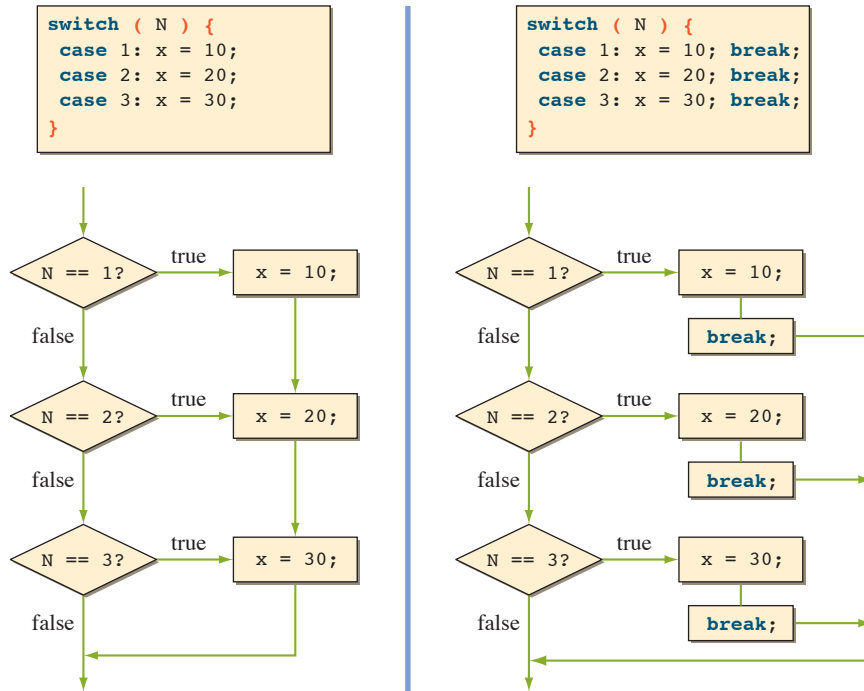

Figure 5.8 A diagram showing the control flow of the `switch` statement with and without the `break` statements.

```

    case 5:
    case 4: System.out.println("Apprentice");
           break;
}

```

The code will print Master if the value of ranking is 10, 9, or 8; Journeyman if the value of ranking is either 7 or 6; or Apprentice if the value of ranking is either 5 or 4.

We may include a default case that will always be executed if there is no matching case. For example, we can add a default case to print out an error message if any invalid value for ranking is entered.

```

switch (ranking) {

    case 10:
    case 9:
    case 8: System.out.println("Master");
           break;

    case 7:
    case 6: System.out.println("Journeyman");
           break;

    case 5:

```

```

        case 4: System.out.println("Apprentice");
                break;

        default: System.out.println("Error: Invalid Data");
                break;
    }

```

There can be at most one default case. Since the execution continues to the next statement if there is no matching case (and no default case is specified), it is safer to always include a default case. By placing some kind of output statement in the default case, we can detect an unexpected switch value. Such a style of programming is characterized as *defensive programming*. Although the default case does not have to be placed as the last case, we recommend you do so, in order to make the switch statement more readable.

defensive
programming



1. What's wrong with the following switch statement?

```

switch ( N ) {
    case 0:
    case 1: x = 11;
            break;

    default: System.out.println("Switch Error");
            break;

    case 2: x = 22;
            break;

    case 1: x = 33;
            break;
}

```

2. What's wrong with the following switch statement?

```

switch ( ranking ) {
    case >4.55: pay = pay * 0.20;
                break;

    case =4.55: pay = pay * 0.15;
                break;

    default:    pay = pay * 0.05;
                break;
}

```

5.6 Drawing Graphics

We introduce four standard classes related to drawing geometric shapes on a window. These four standard classes will be used in Section 5.7 on the sample development. We describe their core features here. More details can be found in the online Java API documentation.

java.awt.Graphics

java.awt.
Graphics

We can draw geometric shapes on a frame window by calling appropriate methods of the Graphics object. For example, if g is a Graphics object, then we can write

```
g.drawRect(50, 50, 100, 30);
```

to display a rectangle 100 pixels wide and 30 pixels high at the specified position (50, 50). The position is determined as illustrated in Figure 5.9. The complete program is shown below. The top left corner, just below the window title bar, is position (0, 0), and the x value increases from left to right and the y value increases from top to bottom. Notice that the direction in which the y value increases is opposite to the normal two-dimensional graph.

content pane
of a frame

The area of a frame which we can draw is called the *content pane of a frame*. The content pane excludes the area of a frame that excludes the regions such as the border, scroll bars, the title bar, the menu bar, and others. To draw on the content pane of a frame window, first we must get the content pane's Graphics object. Then we call this Graphics method to draw geometric shapes. Here's a sample:

```

/*
   Chapter 5 Sample Program: Draw a rectangle on a frame
                           window's content pane

   File: Ch5SampleGraphics.java
*/

import javax.swing.*; //for JFrame
import java.awt.*; //for Graphics and Container

class Ch5SampleGraphics {

    public static void main( String[] args ) {

        JFrame    win;
        Container contentPane;
        Graphics  g;

        win = new JFrame("My First Rectangle");
        win.setSize(300, 200);
        win.setLocation(100,100);
        win.setVisible(true);

        contentPane = win.getContentPane();
        g = contentPane.getGraphics();
        g.drawRect(50,50,100,30);

    }
}

```

win must be visible on the screen before you get its content pane.

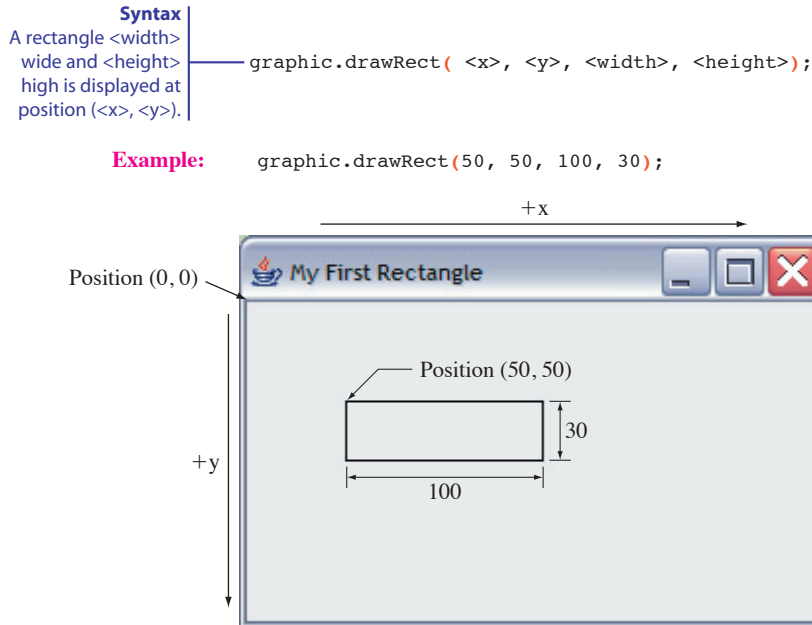

Figure 5.9 The diagram illustrates how the position of the rectangle is determined by the `drawRect` method.

Here are the key points to remember in drawing geometric shapes on the content pane of a frame window.

Things to Remember



To draw geometric shapes on the content pane of a frame window:

1. The content pane is declared as a **Container**, for example, `Container contentPane;`
2. The frame window must be visible on the screen before we can get its content pane and the content pane's **Graphics** object.

Hints, & Tips, Pitfalls



Depending on the speed of your PC, you may have to include the following **try** statement

```
try {Thread.sleep(200);} catch (Exception e) {}
```

to put a delay before drawing the rectangle. Place this **try** statement before the last statement. The argument in the **sleep** method specifies the amount of delay in milliseconds (1000 ms = 1 s). If you still do not see a rectangle drawn in the window after including the delay statement, increase the amount of delay until you see the rectangle drawn. We will describe the **try** statement in Chapter 8.





If there is a window that covers the area in which the drawing takes place or the drawing window is minimized and restored to its normal size, the drawn shape (or portion of it, in the case of the overlapping windows) gets erased. The **DrawingBoard** class used in the sample development (Sec. 5.7) eliminates this problem. For information on the technique to avoid the disappearance of the drawn shape, please check our website at www.mhhe.com/wu

Table 5.4 lists some of the available graphic drawing methods.

Table 5.4 A partial list of drawing methods defined for the `Graphics` class

Method	Meaning
<code>drawLine(x1,y1,x2,y2)</code>	<p>Draws a line between $(x1, y1)$ and $(x2, y2)$.</p>
<code>drawRect(x,y,w,h)</code>	<p>Draws a rectangle with width w and height h at (x, y).</p>
<code>drawRoundRect(x,y,w,h,aw,ah)</code>	<p>Draws a rounded-corner rectangle with width w and height h at (x, y). Parameters aw and ah determine the angle for the rounded corners.</p>

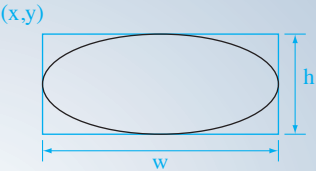
Table 5.4 A partial list of drawing methods defined for the `Graphics` class (Continued)

Method	Meaning
<code>drawOval(x, y, w, h)</code>	<p>Draws an oval with width <code>w</code> and height <code>h</code> at <code>(x, y)</code>.</p> 
<code>drawString("text", x, y)</code>	<p>Draws the string <code>text</code> at <code>(x, y)</code>.</p> 
<code>fillRect(x, y, w, h)</code>	Same as the <code>drawRect</code> method but fills the region with the currently set color.
<code>fillRoundRect(x, y, w, h, aw, ah)</code>	Same as the <code>drawRoundRect</code> method but fills the region with the currently set color.
<code>fillOval(x, y, w, h)</code>	Same as the <code>drawOval</code> method but fills the region with the currently set color.

Notice the distinction between the draw and fill methods. The draw method will draw the boundary only, while the fill method fills the designated area with the currently selected color. Figure 5.10 illustrates the difference.

`java.awt.Color`

`java.awt.Color`

To designate the color for drawing, we will use the `Color` class from the standard `java.awt` package. A `Color` object uses a coloring scheme called the *RGB scheme*, which specifies a color by combining three values, ranging from 0 to 255, for red, green, and blue. For example, the color black is expressed by setting red, green, and blue to 0, and the color white by setting all three values to 255. We create, for example, a `Color` object for the pink color by executing

```
Color pinkColor;
pinkColor = new Color(255,175,175);
```

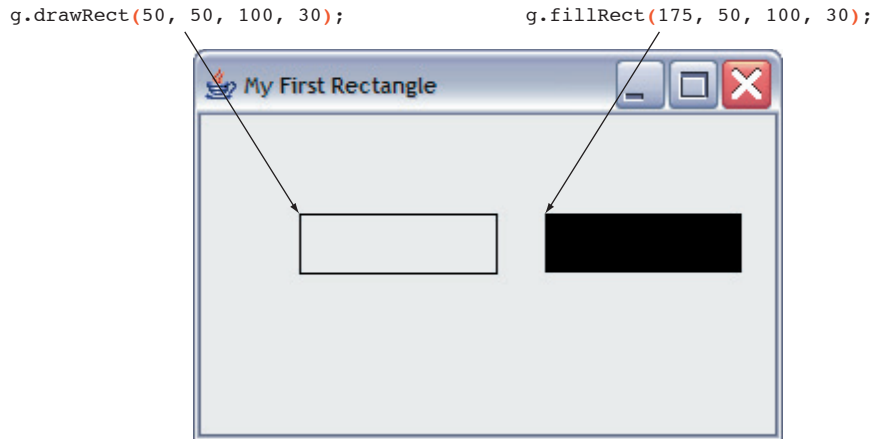

Figure 5.10 The diagram illustrates the distinction between the **draw** and **fill** methods. We assume the currently selected color is black (default).

Instead of dealing with the three numerical values, we can use the public class constants defined in the `Color` class. The class constants for common colors are

<code>Color.BLACK</code>	<code>Color.MAGENTA</code>
<code>Color.BLUE</code>	<code>Color.ORANGE</code>
<code>Color.CYAN</code>	<code>Color.PINK</code>
<code>Color.DARK_GRAY</code>	<code>Color.RED</code>
<code>Color.GRAY</code>	<code>Color.WHITE</code>
<code>Color.GREEN</code>	<code>Color.YELLOW</code>
<code>Color.LIGHT_GRAY</code>	

The class constants in lowercase letters are also defined (such as `Color.black`, `Color.blue`, and so forth). In the older versions of Java, only the constants in lowercase letters were defined. But the Java convention is to name constants using only the uppercase letters, so the uppercase color constants are added to the class definition.

Each of the above is a `Color` object with its RGB values correctly set up. We will pass a `Color` object as an argument to the `setColor` method of the `Graphics` class to change the color. To draw a blue rectangle, for example, we write

```
//Assume g is set correctly
g.setColor(Color.BLUE);
g.drawRect(50, 50, 100, 30);
```

We can also change the background color of a content pane by using the `setBackground` method of `Container` as

```
contentPane.setBackground(Color.LIGHT_GRAY);
```

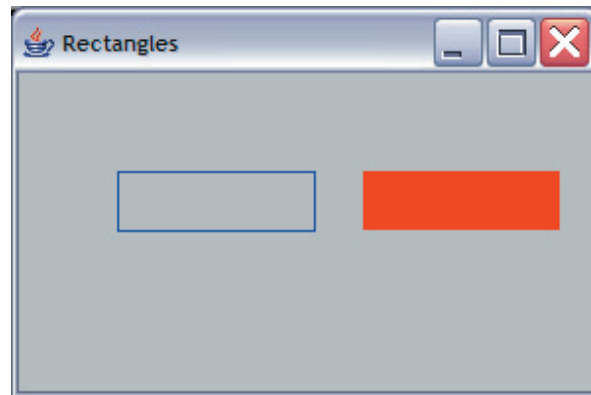

Figure 5.11 A frame with a white background content pane and two rectangles.

Running the following program will result in the frame shown in Figure 5.11.

```

/*
   Chapter 5 Sample Program: Draw one blue rectangle and
                           one filled red rectangle on light gray
                           background content pane

   File: Ch5SampleGraphics2.java
*/

import javax.swing.*;
import java.awt.*;

class Ch5SampleGraphics2 {

    public static void main( String[] args ) {

        JFrame    win;
        Container contentPane;
        Graphics  g;

        win = new JFrame("Rectangles");
        win.setSize(300, 200);
        win.setLocation(100,100);
        win.setVisible(true);

        contentPane = win.getContentPane();
        contentPane.setBackground(Color.LIGHT_GRAY);

        g = contentPane.getGraphics();
        g.setColor(Color.BLUE);
        g.drawRect(50,50,100,30);
    }
}

```

```

g.setColor(Color.RED);
g.fillRect(175,50,100,30);
}
}

```

java.awt.Point

A `Point` object is used to represent a point in two-dimensional space. It contains x and y values, and we can access these values via its public data member x and y . Here's an example to assign a position (10, 20):

```

Point pt = new Point();
pt.x = 10;
pt.y = 20;

```

It is also possible to set the position at the creation time as follows:

```

Point pt = new Point(10, 20);

```

java.awt.Dimension

In manipulating shapes, such as moving them around a frame's content pane, the concept of the bounding rectangle becomes important. A *bounding rectangle* is a rectangle that completely surrounds the shape. Figure 5.12 shows some examples of bounding rectangles.

Just as the (x, y) values are stored as a single `Point` object, we can store the width and height of a bounding rectangle as a single `Dimension` object. The `Dimension` class has the two public data members `width` and `height` to maintain the width and height of a bounding rectangle. Here's an example to create a 40 pixels by 70 pixels high bounding rectangle:

```

Dimension dim = new Dimension();
dim.width = 40;
dim.height = 70;

```

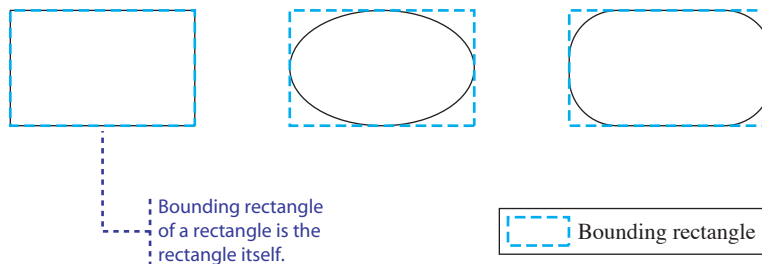

Figure 5.12 Bounding rectangles of various shapes.



Figure 5.13 Sample output of `Ch5RoomWinner` program.

It is also possible to set the values at the creation time as follows:

```
Dimension dim = new Dimension(40, 70);
```

Let's apply the drawing techniques to an early sample program. In Chapter 4, we wrote the `RoomWinner` program that randomly selects and displays the dorm room lottery cards. The display was only in text, something like this:

```
Winning Card Combination:
1 - red; 2 - green; 3 - blue

      color    number
Card 1:      2      13
Card 2:      2      12
Card 3:      1      14
```

We will make a graphical version of the program. Figure 5.13 shows a sample output.

Here's the main class `Ch5RoomWinner`, which has a structure similar to the one for `Ch5SampleGraphics2`.

```
import java.awt.*;
import javax.swing.*;

class Ch5RoomWinner {
    public static void main( String[] args ) {
        JFrame    win;
        Container contentPane;
        Graphics  g;
```

```

GraphicLotteryCard one, two, three;

win = new JFrame("Room Winner");
win.setSize(300, 200);
win.setLocation(100,100);
win.setVisible(true);

contentPane = win.getContentPane();
contentPane.setBackground(Color.WHITE);

g = contentPane.getGraphics();

one = new GraphicLotteryCard ();
two = new GraphicLotteryCard ();
three = new GraphicLotteryCard ();

one.spin();
two.spin();
three.spin();

one.draw(g, 10, 20);
two.draw(g, 50, 20);
three.draw(g, 90, 20);
}
}

```

These objects will draw themselves on g at the specified positions.

We modify the LotteryCard class from Chapter 4 by adding code that will draw a card on a given Graphics context. The name of the new class is GraphicLotteryCard. Here's the class definition (we list only the portions that are new):

```

import java.awt.*;

class GraphicLotteryCard {
    // Data Members

    //width of this card for drawing
    public static final int WIDTH = 30;

    //height of this card for drawing
    public static final int HEIGHT = 40;

    //the other data members and methods are the same as before

    public void draw(Graphics g, int xOrigin, int yOrigin) {
        switch (color) {
            case 1: g.setColor(Color.RED);
                break;

```

```

        case 2: g.setColor(Color.GREEN);
                break;

        case 3: g.setColor(Color.BLUE);
                break;
    }

    g.fillRect(xOrigin, yOrigin, WIDTH, HEIGHT);
    g.setColor(Color.WHITE); //draw text in white
    g.drawString( "" + number", xOrigin + WIDTH/4, yOrigin + HEIGHT/2);
}
}

```

This is a quick way to convert a numerical value to **String**

Notice that the statements in `Ch5RoomWinner`

```

one.draw(g, 10, 20);
two.draw(g, 50, 20);
three.draw(g, 90, 20);

```

are not as flexible as they can be. If the values for the constant `WIDTH` and `HEIGHT` in the `GraphicLotteryCard` class are changed, these three statements could result in drawing the card inadequately (such as overlapping cards). The two constants are declared `public` for a reason. Using the `WIDTH` constant, for example, we can rewrite the three statements as

```

int cardWidth = GraphicLotteryCard.WIDTH;
one.draw(g, 10, 20);
two.draw(g, 10 + cardWidth + 5, 20);
three.draw(g, 10 + 2*(cardWidth+ 5), 20);

```

The statements will draw cards with a 5-pixel interval between cards. This code will continue to work correctly even after the value of `WIDTH` is modified.

5.7 Enumerated Constants

We learned in Section 3.3 how to define numerical constants and the benefits of using them in writing readable programs. In this section, we will introduce an additional type of constant called *enumerated constants* that were added to the Java language from Version 5.0. Let's start with an example. Suppose we want to define a `Student` class and define constants to distinguish four undergraduate grade

enumerated
constants

levels—freshman, sophomore, junior, and senior. Using the numerical constants, we can define the grade levels as such:

```
class Student {
    public static final int FRESHMAN = 0;
    public static final int SOPHOMORE = 1;
    public static final int JUNIOR = 2;
    public static final int SENIOR = 3;
    ...
}
```

With the new enumerated constants, this is how we can define the grade levels in the Student class:

```
class Student {
    public static enum GradeLevel
        {FRESHMAN, SOPHOMORE, JUNIOR, SENIOR}
    ...
}
```

The word `enum` is a new reserved word, and the basic syntax for defining enumerated constants is

```
enum <enumerated type> { <constant values> }
```

where `<enumerated type>` is an identifier and `<constant values>` is a list of identifiers separated by commas. Notice that for the most common usage of enumerated constants, we append the modifiers `public` and `static`; but they are not a required part of defining enumerated constants. Here are more examples:

```
enum Month {JANUARY, FEBRUARY, MARCH, APRIL,
            MAY, JUNE, JULY, AUGUST,
            SEPTEMBER, OCTOBER, NOVEMBER, DECEMBER}
```

```
enum Gender {MALE, FEMALE}
```

```
enum SkillLevel {NOVICE, INTERMEDIATE, ADVANCED, EXPERT}
```

One restriction when declaring an enumerated type is that it cannot be a local declaration. In other words, we must declare it outside of any method, just as for the other data members of a class.

Unlike numerical constants, which are simply identifiers with fixed numerical values, enumerated constants do not have any assigned numerical values. They are said to belong to, or be members of, the associated *enumerated type*. For example, two enumerated constants `MALE` and `FEMALE` belong to the enumerated type `Gender`. (*Note:* We keep the discussion of the enumerated type to its simplest form here. It is beyond the scope of an introductory programming textbook to discuss Java's enumerated type in full detail.)

enumerated
type

Just as with any other data types, we can declare variables of an enumerated type and assign values to them. Here is an example (for the sake of brevity, we list the enum declaration and its usage together, but remember that the declaration in the actual use cannot be a local declaration):

```
enum Fruit {APPLE, ORANGE, BANANA}
Fruit f1, f2, f3;
f1 = Fruit.APPLE;
f2 = Fruit.BANANA;
f3 = f1;
```

NOTE: The constant value is prefixed by the name of the enumerated type.

type safety

Because variables `f1`, `f2`, and `f3` are declared to be of the type `Fruit`, we can only assign one of the associated enumerated constants to them. This restriction supports a desired feature called *type safety*. So what is the big deal? Consider the following numerical constants and assignment statements:

```
final int APPLE = 1;
final int ORANGE = 2;
final int BANANA = 3;

int fOne, fTwo, fThree;

fOne = APPLE;
fTwo = ORANGE;
fThree = fOne;
```

The code may look comparable to the one that uses enumerated constants, but what will happen if we write the following?

```
fOne = 45;
```

The assignment is logically wrong. It does not make any sense to assign meaningless value such as 45 to the variable `fOne` if it is supposed to represent one of the defined fruit. However, no compiler error will result because the data type of `fOne` is `int`. The statement may or may not cause the runtime error depending on how the variable `fOne` is used in the rest of the program. In either case, the program cannot be expected to produce a correct result because of the logical error.

By defining an enumerated type, a variable of that type can only accept the associated enumerated constants. Any violation will be detected by the compiler. This will eliminate the possibility of assigning a nonsensical value as seen in the case for the numerical constants. Type safety means that we can assign only meaningful values to a declared variable.

Another benefit of the enumerated type is the informative output values. Assuming the variables `fTwo` and `f2` retain the values assigned to them in the sample code, the statement

```
System.out.println("Favorite fruit is " + fTwo);
```

will produce a cryptic output:

```
Favorite fruit is 2
```

In contrast, the statement

```
System.out.println("Favorite fruit is " + f2);
```

will produce a more informative output:

```
Favorite fruit is BANANA
```

We will describe other advantages of using enumerated types later in the book.

As shown, when referring to an enumerated constant in the code, we must prefix it with its enumerated type name, for example,

```
Fruit f = Fruit.APPLE;
. . .
if (f == Fruit.ORANGE) {
    System.out.println("I like orange, too.");
}
. . .
```

A case label for a switch statement is the only exception to this rule. Instead of writing, for example,

```
Fruit fruit;
fruit = ... ;
switch (fruit) {
    case Fruit.APPLE: . . . ;
                        break;
    case Fruit.ORANGE: . . . ;
                        break;
    case Fruit.BANANA: . . . ;
                        break;
}
```

we can specify the case labels without the prefix as in

```
Fruit fruit;
fruit = ... ;
switch (fruit) {
    case APPLE: . . . ;
                break;
}
```

```

        case ORANGE: . . . ;
            break;

        case BANANA: . . . ;
            break;
    }

```

Hints, & Tips, Pitfalls



It is not necessary to prefix the enumerated constant with its enumerated type name when it is used as a **case** label in a **switch** statement.

The enumerated type supports a useful method named `valueOf`. The method accepts one `String` argument and returns the enumerated constant whose value matches the given argument. For example, the following statement assigns the enumerated constant `APPLE` to the variable `fruit`:

```
Fruit fruit = Fruit.valueOf("APPLE");
```

In which situations could the `valueOf` method be useful? One is the input routine. Consider the following:

```

Scanner scanner = new Scanner(System.in);
System.out.print("Enter your favorite fruit " +
                "(APPLE, ORANGE, BANANA): ");
String fruitName = scanner.next( );
Fruit favoriteFruit = Fruit.valueOf(fruitName);

```

Be aware, however, that if you pass a `String` value that does not match any of the defined constants, it will result in a runtime error. This means if the user enters `Orange`, for example, it will result in an error (the input has to be all capital letters to match). We will discuss how to handle such runtime errors without causing the program to terminate abruptly in Chapter 8.

To access the enumerated constants in a programmer-defined class from outside the class, we must reference them through the associated enumerated type (assuming, of course, the visibility modifier is `public`). Consider the following `Faculty` class:

```

class Faculty {
    public static enum Rank
        {LECTURER, ASSISTANT, ASSOCIATE, FULL}

    private Rank rank;

    . . .
}

```

```

public void setRank(Rank r) {
    rank = r;
}

public Rank getRank( ) {
    return rank;
}

. . .
}

```

Notice how the enumerate type Rank is used in the setRank and getRank methods. It is treated just as any other types are. To access the Rank constants from outside of the Faculty class, we write

```

Faculty.Rank.ASSISTANT

Faculty.Rank.FULL

```

and so forth. Here's an example that assigns the rank of ASSISTANT to a Faculty object:

```

Faculty prof = new Faculty(...);
prof.setRank(Faculty.Rank.ASSISTANT);

```

And here's an example to retrieve the rank of a Faculty object:

```

Faculty teacher;
//assume 'teacher' is properly created
Faculty.Rank rank;
rank = teacher.getRank();

```



1. Define an enumerated type Day that includes the constants SUNDAY through SATURDAY.
2. What is the method that returns an enumerated constant, given the matching String value?
3. Detect the error(s) in the following code:

```

enum Fruit {APPLE, ORANGE, BANANA}
Fruit f1, f2;
int f3;
f1 = 1;
f2 = ORANGE;
f3 = f1;
f1 = "BANANA";

```

5.8 Sample Development

Drawing Shapes

When a certain period of time passes without any activity on a computer, a screensaver becomes active and draws different types of geometric patterns or textual messages. In this section we will develop an application that simulates a screensaver. We will learn a development skill very commonly used in object-oriented programming. Whether we develop alone or as a project team member, we often find ourselves writing a class that needs to behave in a specific way so that it works correctly with other classes. The other classes may come from standard Java packages or could be developed by the other team members.

In this particular case, we use the **DrawingBoard** class (written by the author). This is a helper class that takes care of programming aspects we have not yet mastered, such as moving multiple geometric shapes in a smooth motion across the screen. It is not an issue of whether we can develop this class by ourselves, because no matter how good we become as programmers, we would rarely develop an application completely on our own.

We already used many predefined classes from the Java standard libraries, but the way we will use the predefined class here is different. When we developed programs before, the classes we wrote called the methods of predefined classes. Our main method creating a **GregorianCalendar** object and calling its methods is one example. Here, for us to use a predefined class, we must define another class that provides necessary services to this predefined class. Figure 5.14 differentiates the two types of predefined classes. The first type does not place any restriction other than calling the methods correctly, while the second type requires us to implement helper classes in a specific manner to support it.

In our case, the predefined class **DrawingBoard** will require another class named **DrawableShape** that will assume the responsibility of drawing individual geometric shapes. So, to use the **DrawingBoard** class in our program, we must implement the class named **DrawableShape**. And we must implement the **DrawableShape** class in a specific way. The use of the **DrawingBoard** class dictates that we define a set of fixed methods in the **DrawableShape** class. We can add more, but we must at the minimum provide the specified set of fixed methods because the **DrawingBoard** class will need to call these methods. The methods are “fixed” in the method signature—method name, the number of parameters and their types, and return type—but the method body can be defined in any way we like. This is how the flexibility is achieved. For example, the **DrawableShape** class we define must include a method named **draw** with the dictated signature. But it’s up to us to decide what we put in the method body. So we can choose, for example, to implement the method to draw a circle, rectangle, or any other geometric shape of our choosing.

As always, we will develop this program following incremental development steps. The incremental development steps we will take here are slightly different in character from those we have seen so far. In the previous incremental developments, we knew all the ingredients, so to speak. Here we have to include a step to explore the **DrawingBoard** class. We will find out shortly that to use the **DrawingBoard** class, we will have to deal with some Java standard classes we have not seen yet. Pedagogically, a textbook may try to

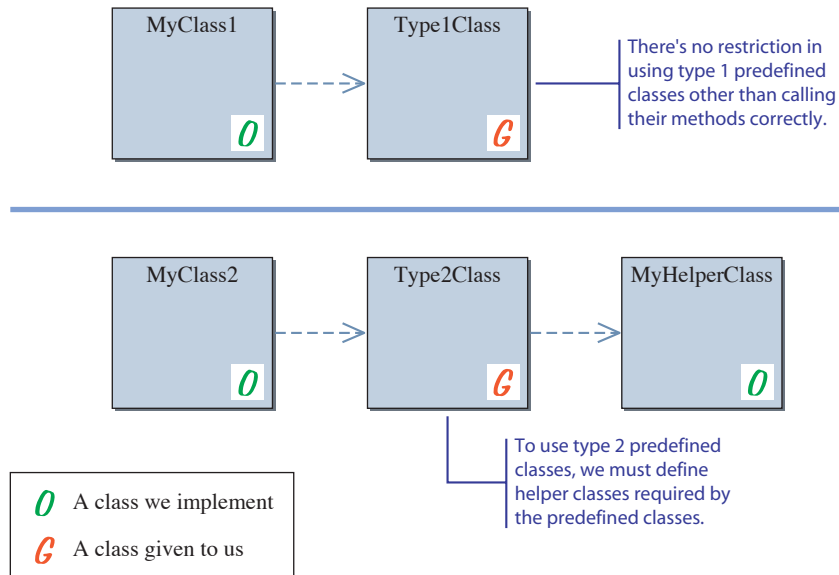

Figure 5.14 Two types of predefined classes. The first type does not require us to do anything more than use the predefined classes by calling their methods. The second type requires us to define helper classes for the predefined classes we want to use.

explain beforehand everything that is necessary to understand the sample programs. But no textbook can explain everything. When we develop programs, there will always be a time when we encounter some unknown classes. We need to learn how to deal with such a situation in our development steps.

Problem Statement

Write an application that simulates a screensaver by drawing various geometric shapes in different colors. The user has the option of choosing a type (ellipse or rectangle), color, and movement (stationary, smooth, or random).

Overall Plan

We will begin with our overall plan for the development. Let's begin with the outline of program logic. We first let the user select the shape, its movement, and its color, and we then start drawing. We express the program flow as having four tasks:

program
tasks

1. Get the shape the user wants to draw.
2. Get the color of the chosen shape.
3. Get the type of movement the user wants to use.
4. Start the drawing.

5.8 Sample Development—continued

Let's look at each task and determine an object that will be responsible for handling the task. For the first three tasks, we can use our old friend **Scanner**. We will get into the details of exactly how we ask the users to input those values in the later incremental steps. For the last task of actually drawing the selected shape, we need to define our own class. The task is too specific to the program, and there is no suitable object in the standard packages that does the job. As discussed earlier, we will use a given predefined class **DrawingBoard** and define the required helper class **DrawableShape**.

We will define a top-level control object that manages all these objects. We will call this class **Ch5DrawShape**. As explained in Section 4.10, we will make this control object the main class. Here's our working design document:

program
classes

Design Document: Ch5DrawShape	
Class	Purpose
Ch5DrawShape	The top-level control object that manages other objects in the program. This is the main class, as explained in Section 4.10.
DrawingBoard	The given predefined class that handles the movement of DrawableShape objects.
DrawableShape	The class for handling the drawing of individual shapes.
Scanner	The standard class for handling input routines.

Figure 5.15 is the program diagram for this program.

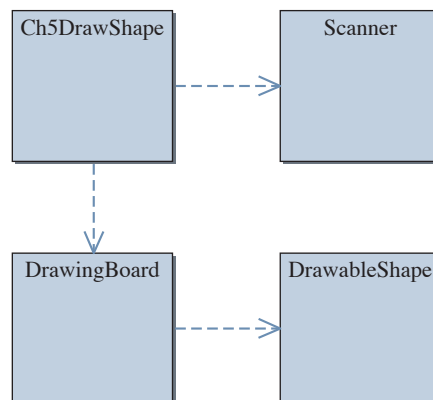

Figure 5.15 The program diagram for the **Ch5DrawShape** program.

development
steps

We will implement this program in the following six major steps:

1. Start with a program skeleton. Explore the **DrawingBoard** class.
2. Define an experimental **DrawableShape** class that draws a dummy shape.
3. Add code to allow the user to select a shape. Extend the **DrawableShape** and other classes as necessary.
4. Add code to allow the user to specify the color. Extend the **DrawableShape** and other classes as necessary.
5. Add code to allow the user to specify the motion type. Extend the **DrawableShape** and other classes as necessary.
6. Finalize the code by tying up loose ends.

Our first task is to find out about the given class. We could have designed the input routines first, but without knowing much about the given class, it would be difficult to design suitable input routines. When we use an unknown class, it is most appropriate to find out more about this given class before we plan any input or output routines. Just as the development steps are incremental, our exploration of the given class will be incremental. Instead of trying to find out everything about the class at once, we begin with the basic features and skeleton code. As we learn more about the given class incrementally, we extend our code correspondingly.

Step 1 Development: Program Skeleton

step 1
design

We begin the development with the skeleton main class. The main purpose in step 1 is to use the **DrawingBoard** class in the simplest manner to establish the launch pad for the development. To do so, we must first learn a bit about the given **DrawingBoard** class. Here's a brief description of the **DrawingBoard** class. In a real-world situation, we would be finding out about the given class by reading its accompanying documentation or some other external sources. The documentation may come in form of online javadoc documents or reference manuals.

DrawingBoard
<p>An instance of this class will support the drawing of <code>DrawableShape</code> objects. Shapes can be drawn at fixed stationary positions, at random positions, or in a smooth motion at the specified speed. The actual drawing of the individual shapes is done inside the <code>DrawableShape</code> class. The client programmer decides which shape to draw.</p> <pre>public void addShape (DrawableShape shape) Adds shape to this DrawingBoard object. You can add an unlimited number of DrawableShape objects.</pre>

(Continued)

5.8 Sample Development—continued

DrawingBoard (Continued)

```
public void setBackground( java.awt.Color color )
    Sets the background color of this DrawingBoard object to the designated
    color. The default background color is black.
```

```
public void setDelayTime( double delay )
    Sets the delay time between drawings to delay seconds. The smaller the delay
    time, the faster the shapes move. If the movement type is other than SMOOTH,
    then setting the delay time has no visual effect.
```

```
public void setMovement( Movement type )
    Sets the movement type to type. Class constants for three types of motion are
    Movement.STATIONARY—draw shapes at fixed positions,
    Movement.RANDOM—draw shapes at random positions, and
    Movement.SMOOTH—draw shapes in a smooth motion.
```

```
public void setVisible( boolean state )
    Makes this DrawingBoard object appear on or disappear from the screen
    if state is true or false, respectively. To simulate the screensaver,
    setting it visible will cause a maximized window to appear on the screen.
```

```
public void start( )
    Starts the drawing. If the window is not visible yet, it will be made visible before
    the drawing begins.
```

Among the defined methods, we see the **setVisible** method is the one to make it appear on the screen. All other methods pertain to adding **DrawableShape** objects and setting the properties of a **DrawingBoard** object. We will explain the standard **java.awt.Color** class when we use the **setBackground** method in the later step. In this step, we will keep the code very simple by only making it appear on the screen. We will deal with other methods in the later steps.

Our working design document for the **Ch5DrawShape** class is as follows:

Design Document: The Ch5DrawShape Class		
Method	Visibility	Purpose
<constructor>	public	Creates a DrawingBoard object.
main	public	This is main method of the class.
start	public	Starts the program by opening a DrawingBoard object.

step 1 code

Since this is a skeleton code, it is very basic. Here's the code:

```

/*
    Chapter 5 Sample Development: Drawing Shapes (Step 1)

    The main class of the program.
*/
class Ch5DrawShape {
    private DrawingBoard canvas;
    public Ch5DrawShape( ) {
        canvas = new DrawingBoard( );
    }
    public void start( ) {
        canvas.setVisible(true);
    }
    public static void main(String[] args) {
        Ch5DrawShape screensaver = new Ch5DrawShape( );
        screensaver.start();
    }
}

```

step 1 test

The purpose of step 1 testing is to verify that a **DrawingBoard** object appears correctly on the screen. Since this is our first encounter with the **DrawingBoard** class, it is probable that we are not understanding its documentation fully and completely. We need to verify this in this step. When a maximized window with the black background appears on the screen, we know the main class was executed properly. After we verify the correct execution of the step 1 program, we will proceed to implement additional methods of **Ch5DrawShape** and gradually build up the required **DrawableShape** class.

Step 2 Development: Draw a Shape

step 2 design

In the second development step, we will implement a preliminary **DrawableShape** class and make some shapes appear on a **DrawingBoard** window. To draw shapes, we need to add them to a **DrawingBoard** window. And to do so, we need to define the

5.8 Sample Development—continued

DrawableShape class with the specified set of methods. Here are the required methods and a brief description of what to accomplish in them:

Required Methods of DrawableShape	
<code>public void draw(java.awt.Graphics)</code>	Draw a geometric shape on the <code>java.awt.Graphics</code> . The <code>DrawingBoard</code> window calls the <code>draw</code> method of <code>DrawableShape</code> objects added to it.
<code>public java.awt.Point getCenterPoint()</code>	Return the center point of this shape.
<code>public java.awt.Dimension getDimension()</code>	Return the bounding rectangle of this shape as a <code>Dimension</code> .
<code>public void setCenterPoint(java.awt.Point)</code>	Set the center point of this shape. The <code>DrawingBoard</code> window calls the <code>setCenterPoint</code> method of <code>DrawableShape</code> objects to update their positions in the <code>SMOOTH</code> movement type.

At this stage, the main task is for us to confirm our understanding of the requirements in implementing the **DrawableShape** class. Once we get this confirmation, we can get into the details of the full-blown **DrawableShape** class.

To keep the preliminary class simple, we draw three filled circles of a fixed size and color. The **DrawableShape** class includes a single data member **centerPoint** to keep track of the shape's center point. If we fix the radius of the circles to 100 pixels, that is, the bounding rectangle is 200 pixels by 200 pixels, and the color to blue, then the **draw** method can be written as follows:

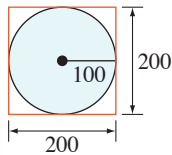

```
public void draw(Graphics g) {
    g.setColor(Color.blue);
    g.fillOval(centerPoint.x-100, centerPoint.y-100, 200, 200);
}
```

Since the size is fixed, we simply return a new **Dimension** object for the **getDimension** method:

```
public Dimension getDimension( ) {
    return new Dimension(200, 200);
}
```

For the **setCenterPoint** and **getCenterPoint** methods, we assign the passed parameter to the data member **centerPoint** and return the current value of the data member **centerPoint**, respectively.

We are now ready to modify the **Ch5DrawShape** class to draw three filled circles. We will implement this by modifying the **start** method. First we need to create three **DrawableShape** objects and add them to the **DrawingBoard** object **canvas**:

```
DrawableShape shape1 = new DrawableShape ();
DrawableShape shape2 = new DrawableShape ();
DrawableShape shape3 = new DrawableShape ();

shape1.setCenterPoint(new Point(250,300));
shape2.setCenterPoint(new Point(500,300));
shape3.setCenterPoint(new Point(750,300));

canvas.addShape(shape1);
canvas.addShape(shape2);
canvas.addShape(shape3);
```

Then we set the motion type to **SMOOTH** movement, make the window appear on the screen, and start the drawing:

```
canvas.setMovement(DrawingBoard.Movement.SMOOTH);
canvas.setVisible(true);
canvas.start();
```

step 2 code

Here's the code for the preliminary **DrawableShape** class:

```
import java.awt.*;

/*
  Step 2: Add a preliminary DrawableShape class
  A class whose instances know how to draw themselves.
  */
class DrawableShape {
    private Point centerPoint;

    public DrawableShape() {
        centerPoint = null;
    }

    public void draw(Graphics g) {
        g.setColor(Color.blue);
        g.fillOval(centerPoint.x-100, centerPoint.y-100, 200, 200);
    }
}
```

Data Members

Constructors

draw

5.8 Sample Development—continued

```

public Point getCenterPoint( ) {
    return centerPoint;
}

public Dimension getDimension( ) {
    return new Dimension(200, 200);
}

public void setCenterPoint(Point point) {
    centerPoint = point;
}
}

```

getCenterPoint

getDimension

setCenterPoint

The **Ch5DrawShape** class now has the modified **start** method as designed (the rest of the class remains the same):

```

import java.awt.*;

/*
   Chapter 5 Sample Development: Start drawing shapes (Step 2)
   The main class of the program.
*/

class Ch5DrawShape {
    . . .

    public void start( ) {

        DrawableShape shape1 = new DrawableShape();
        DrawableShape shape2 = new DrawableShape();
        DrawableShape shape3 = new DrawableShape();

        shape1.setCenterPoint(new Point(250,300));
        shape2.setCenterPoint(new Point(500,300));
        shape3.setCenterPoint(new Point(750,300));

        canvas.addShape(shape1);
        canvas.addShape(shape2);
        canvas.addShape(shape3);
    }
}

```

start

```

        canvas.setMovement(DrawingBoard.Movement.SMOOTH);
        canvas.setVisible(true);
        canvas.start();
    }
    . . .
}

```

step 2 test

Now we run the program and verify the three bouncing circles moving around. To test other options of the **DrawingBoard** class, we will try the other methods with different parameters:

Method	Test Parameter
setMovement	Try both <code>DrawingBoard.STATIONARY</code> and <code>DrawingBoard.RANDOM</code> .
setDelayTime	Try values ranging from 0.1 to 3.0.
setBackground	Try several different <code>Color</code> constants such as <code>Color.white</code> , <code>Color.red</code> , and <code>Color.green</code> .

We insert these testing statements before the statement

```
canvas.setVisible(true);
```

in the **start** method.

Another testing option we should try is the drawing of different geometric shapes. We can replace the drawing statement inside the **draw** method from

```
g.fillOval(centerPoint.x-100, centerPoint.y-100,
           200, 200);
```

to

```
g.fillRect(centerPoint.x-100, centerPoint.y-100,
           200, 200);
```

or

```
g.fillRoundRect(centerPoint.x-100, centerPoint.y-100,
                200, 200, 50, 50);
```

to draw a filled rectangle or a filled rounded rectangle, respectively.

5.8 Sample Development—continued

step 3
design**Step 3 Development: Allow the User to Select a Shape**

Now that we know how to interact with the **DrawingBoard** class, we can proceed to develop the user interface portion of the program. There are three categories in which the user can select an option: shape, color, and motion. We will work on the shape selection here and on the color and motion selection in the next two steps. Once we are done with this step, the next two steps are fairly straightforward because the idea is essentially the same.

Let's allow the user to select one of three shapes—ellipse, rectangle, and rounded rectangle—the shapes we know how to draw at this point. We can add more fancy shapes later. In what ways should we allow the user to input the shape? There are two possible alternatives: The first would ask the user to enter the text and spell out the shape, and the second would ask the user to enter a number that corresponds to the shape (1 for ellipse, 2 for rectangle, 3 for rounded rectangle, e.g.). Which is the better alternative?

design
alternative 1

We anticipate at least two problems with the first input style. When we need to get a user's name, for example, there's no good alternative other than asking the user to enter his or her name. But when we want the user to select one of the few available choices, it is cumbersome and too much of a burden for the user. Moreover, it is prone to mistyping.

design
alternative 2

To allow the user to make a selection quickly and easily, we can let the user select one of the available choices by entering a corresponding number. We will list the choices with numbers 1, 2, and 3 and get the user's selection as follows:

```
System.out.print("Selection: Enter the Shape number\n" +
    " 1 - Ellipse \n" +
    " 2 - Rectangle \n" +
    " 3 - Rounded Rectangle \n");

int selection = scanner.nextInt();
```

For getting the dimension of the shape, we accept the width and height values from the user. The values cannot be negative, for sure, but we also want to restrict the values to a certain range. We do not want the shape to be too small or too large. Let's set the minimum to 100 pixels and the maximum to 500 pixels. If the user enters a value outside the acceptable range, we will set the value to 100. The input routine for the width can be written as follows:

```
System.out.print("Enter the width of the shape\n" +
    "between 100 and 500 inclusive: ");

int width = scanner.nextInt();
if (width < 100 || width > 500) {
    width = 100;
}
```

The input routine for the height will work in the same manner.

For getting the **x** and **y** values of the shape's center point, we follow the pattern of getting the width and height values. We will set the acceptable range for the **x** value to 200 and 800, inclusive, and the **y** value to 100 and 600, inclusive.

Our next task is to modify the **DrawableShape** class so it will be able to draw three different geometric shapes. First we change the constructor to accept the three input values:

```
public DrawableShape(Type sType, Dimension sDim,
                    Point sCenter) {
    type        = sType;
    dimension    = sDim;
    centerPoint = sCenter;
}
```

The variables **type**, **dimension**, and **centerPoint** are data members for keeping track of necessary information.

Next, we define the data member constants as follows:

```
public static enum Type {ELLIPSE, RECTANGLE, ROUNDED_RECTANGLE}
private static final Dimension DEFAULT_DIMENSION
    = new Dimension(200, 200);
private static final Point DEFAULT_CENTER_PT
    = new Point(350, 350);
```

In the previous step, the **draw** method drew a fixed-size circle. We need to modify it to draw three different geometric shapes based on the value of the data member **type**. We can modify the method to

```
public void draw(Graphics g) {
    g.setColor(Color.blue);
    drawShape(g);
}
```

with the private method **drawShape** defined as

```
private void drawShape(Graphics g) {
    switch (type) {
        case ELLIPSE:
            //code to draw a filled oval comes here
            break;
        case RECTANGLE:
            //code to draw a filled rectangle comes here
            break;
    }
```

5.8 Sample Development—continued

```

        case ROUNDED_RECTANGLE:
            //code to draw a filled rounded rectangle
            //comes here
            break;
    }
}

```

step 3 code

Here's the modified main class **Ch5DrawShape**:

```

import java.awt.*;
import java.util.*;

/*
    Chapter 5 Sample Development: Handle User Input for Shape Type (Step 3)
    The main class of the program.
*/

class Ch5DrawShape {
    . . .

    public void start( ) {
        DrawableShape shape1 = getShape();
        canvas.addShape(shape1);
        canvas.setMovement(DrawingBoard.SMOOTH);
        canvas.setVisible(true);
        canvas.start();
    }

    private DrawableShape getShape( ) {
        DrawableShape.Type type = inputShapeType();
        Dimension dim = inputDimension();
        Point centerPt = inputCenterPoint();
        DrawableShape shape = new DrawableShape(type, dim, centerPt);
        return shape;
    }
}

```

start

getShape

```

private DrawableShape.Type inputShapeType( ) {
    System.out.print("Selection: Enter the Shape number\n" +
        "    1 - Ellipse \n" +
        "    2 - Rectangle \n" +
        "    3 - Rounded Rectangle \n");

    int selection = scanner.nextInt();

    DrawableShape.Type type;

    switch (selection) {
        case 1: type = DrawableShape.Type.ELLIPSE;
                break;

        case 2: type = DrawableShape.Type.RECTANGLE;
                break;

        case 3: type = DrawableShape.Type.ROUNDED_RECTANGLE;
                break;

        default: type = DrawableShape.Type.ELLIPSE;
                 break;
    }

    return type;
}

```

inputShapeType

```

private Dimension inputDimension( ) {
    System.out.print("Enter the width of the shape\n" +
        "between 100 and 500 inclusive: ");

    int width = scanner.nextInt();

    if (width < 100 || width > 500) {
        width = 100;
    }

    System.out.print("Enter the height of the shape\n" +
        "between 100 and 500 inclusive: ");

    int height = scanner.nextInt();

    if (height < 100 || height > 500) {
        height = 100;
    }

    return new Dimension(width, height);
}

```

inputDimension

5.8 Sample Development—continued

```

private Point inputCenterPoint( ) {
    System.out.print("Enter the x value of the center point\n" +
        "between 200 and 800 inclusive: ");

    int x = scanner.nextInt();

    if (x < 200 || x > 800) {
        x = 200;
    }

    System.out.print("Enter the y value of the center point\n" +
        "between 100 and 500 inclusive: ");

    int y = scanner.nextInt();

    if (y < 100 || y > 500) {
        y = 100;
    }

    return new Point(x, y);
}
. . .
}

```

inputCenterPoint

The **DrawableShape** class is now modified to this:

```

import java.awt.*;

/*
    Step 3: Draw different shapes
    A class whose instances know how to draw themselves.
*/

class DrawableShape {
    public static enum Type {ELLIPSE, RECTANGLE, ROUNDED_RECTANGLE}

    private static final Dimension DEFAULT_DIMENSION
        = new Dimension(200, 200);
}

```

Data Members

```

private static final Point DEFAULT_CENTER_PT = new Point(350, 350);
private Point      centerPoint;
private Dimension  dimension;
private Type       type;
public DrawableShape(Type sType, Dimension sDim, Point sCenter) {
    type      = sType;
    dimension = sDim;
    centerPoint = sCenter;
}
public void draw(Graphics g) {
    g.setColor(Color.blue);
    drawShape(g);
}
. . .
public void setType(Type shapeType) {
    type = shapeType;
}
private void drawShape(Graphics g) {
    switch (type) {
        case ELLIPSE:
            g.fillOval(centerPoint.x - dimension.width/2,
                       centerPoint.y - dimension.height/2,
                       dimension.width,
                       dimension.height);
            break;
        case RECTANGLE:
            g.fillRect(centerPoint.x - dimension.width/2,
                       centerPoint.y - dimension.height/2,
                       dimension.width,
                       dimension.height);
            break;
        case ROUNDED_RECTANGLE:
            g.fillRoundRect(centerPoint.x - dimension.width/2,
                             centerPoint.y - dimension.height/2,
                             dimension.width,
                             dimension.height,

```

Constructor

draw

setType

drawShape

5.8 Sample Development—continued

```

        (int) (dimension.width * 0.3),
        (int) (dimension.height * 0.3));
    }
    break;
}
}
}

```

Notice how we add code for handling the case when an invalid number is entered in the **inputShapeType** method. We use the **default** case to set the shape type to **ELLIPSE** if an invalid value is entered. In addition to handling the invalid entries, it is critical for us to make sure that all valid entries are handled correctly. For example, we cannot leave the type undefined or assigned to a wrong value when one of the valid data is entered.

Things to Remember



When we write a selection control statement, we must make sure that all possible cases are handled correctly.

step 3 test

Now we run the program multiple times, trying various shape types, dimensions, and center points. After we verify that everything is working as expected, we proceed to the next step.

Step 4 Development: Allow the User to Select a Color

step 4 design

In the fourth development step, we add a routine that allows the user to specify the color of the selected shape. We adopt the same input style for accepting the shape type as in step 3. We list five different color choices and let the user select one of them by entering the corresponding number. We use a default color when an invalid number is entered. Analogous to the shape selection routine, we will add a method named **inputColor** to the **Ch5DrawShape** class. The structure of this method is identical to that of the input methods, except the return type is **Color**. Using the **inputColor** method, we can define the **getShape** method as follows:

```

private DrawableShape getShape( ) {
    DrawableShape.Type type = inputShapeType();
    Dimension dim = inputDimension();
}

```

```

    Point centerPt = inputCenterPoint();
    Color color = inputColor();
    DrawableShape shape
        = new DrawableShape(type, dim, centerPt, color);
    return shape;
}

```

We make a small extension to the **DrawableShape** class by changing the constructor to accept a color as its fourth argument and adding a data member to keep track of the selected color.

step 4 code

Here's the modified **Ch5DrawShape** class:

```

import java.awt.*;
import java.util.*;

/*
    Chapter 5 Sample Development: Color selection (Step 4)
    The main class of the program.
*/

class Ch5DrawShape {
    . . .

    private DrawableShape getShape( ) {
        DrawableShape.Type type = inputShapeType();
        Dimension dim = inputDimension();
        Point centerPt = inputCenterPoint();
        Color color = inputColor();

        DrawableShape shape
            = new DrawableShape(type, dim, centerPt, color);
        return shape;
    }

    private Color inputColor( ) {
        System.out.print("Selection: Enter the Color number\n" +
            "    1 - Red \n" +
            "    2 - Green \n" +
            "    3 - Blue \n" +
            "    4 - Yellow \n" +
            "    5 - Magenta \n");

        int selection = scanner.nextInt();
    }
}

```

getShape

inputColor

5.8 Sample Development—continued

```

Color color;
switch (selection) {
    case 1: color = Color.red;
           break;
    case 2: color = Color.green;
           break;
    case 3: color = Color.blue;
           break;
    case 4: color = Color.yellow;
           break;
    case 5: color = Color.magenta;
           break;
    default: color = Color.red;
            break;
}
return color;
}
...
}

```

The **DrawableShape** class is now modified to this:

```

import java.awt.*;

/*
   Step 4: Adds the color choice
   A class whose instances know how to draw themselves.
*/
class DrawableShape {
    ...
    private static final Color DEFAULT_COLOR = Color.BLUE;
    ...
}

```

Data Members

```

private Color    fillColor;
. . .
public DrawableShape(Type sType, Dimension sDim,
                    Point sCenter, Color sColor) {
    type        = sType;
    dimension   = sDim;
    centerPoint = sCenter;
    fillColor   = sColor;
}

public void draw(Graphics g) {
    g.setColor(fillColor);
    drawShape(g);
}
. . .
}

```

Constructor

draw

step 4 test

Now we run the program several times, each time selecting a different color, and we verify that the shape is drawn in the chosen color. After we verify the program, we move on to the next step.

Step 5 Development: Allow the User to Select a Motion Type

step 5
design

In the fifth development step, we add a routine that allows the user to select the motion type. We give three choices to the user: stationary, random, or smooth. The same design we used in steps 3 and 4 is applicable here, so we adopt it for the motion type selection also. Since we adopt the same design, we can ease into the coding phase.

step 5 code

Here's the modified main class **Ch5DrawShape**:

```

import java.awt.*;
import java.util.*;

/*
   Chapter 5 Sample Development: Color selection (Step 5)
   The main class of the program.
*/
class Ch5DrawShape {
    . . .
}

```

5.8 Sample Development—continued

```

public void start( ) {
    DrawableShape shapel = getShape();
    canvas.addShape(shapel);
    canvas.setMovement(inputMotionType());
    canvas.setVisible(true);
    canvas.start();
}
. . .
private DrawingBoard.Movement inputMotionType( ) {
    System.out.print("Selection: Enter the Motion number\n" +
        " 1 - Stationary (no movement) \n" +
        " 2 - Random Movement \n" +
        " 3 - Smooth Movement \n" );

    int selection = scanner.nextInt();

    DrawingBoard.Movement type;
    switch (selection) {
        case 1: type = DrawingBoard.Movement.STATIONARY;
                break;
        case 2: type = DrawingBoard.Movement.RANDOM;
                break;
        case 3: type = DrawingBoard.Movement.SMOOTH;
                break;
        default: type = DrawingBoard.Movement.SMOOTH;
                 break;
    }
    return type;
}
. . .
}

```

start

inputMotionType

No changes are required for the **DrawableShape** class, as the **DrawingBoard** class is the one responsible for the shape movement.

step 5 test

Now we run the program multiple times and test all three motion types. From what we have done, we can't imagine the code we have already written in the earlier steps to cause any problems; but if we are not careful, a slight change in one step could cause the code developed from the earlier steps to stop working correctly (e.g., erroneously reusing data members in newly written methods). So we should continue to test all aspects of the program diligently. After we are satisfied with the program, we proceed to the final step.

Step 6 Development: Finalize

program review

We will perform a critical review of the program, looking for any unfinished method, inconsistency or error in the methods, unclear or missing comments, and so forth. We should also not forget to improve the program for cleaner code and better readability. Another activity we can pursue in the final step is to look for extensions.

possible extensions

There are several interesting extensions we can make to the program. First is the morphing of an object. In the current implementation, once the shape is selected, it will not change. It would be more fun to see the shape changes; for example, the width and height of the shape's dimension can be set to vary while the shape is drawn. Another interesting variation is to make a circle morph into a rectangle and morph back into a circle. Second is the drawing of multiple shapes. Third is the variation in color while the shape is drawn. Fourth is the drawing of a text (we "draw" a text on the **Graphics** context just as we draw geometric shapes). You can make the text scroll across the screen from right to left by setting the motion type of **DrawingBoard** to **STATIONARY** and updating the center point value within our **DrawableShape** class. All these extensions are left as exercises.

Summary

- A selection control statement is used to alter the sequential flow of control.
- The if and switch statements are two types of selection control.
- The two versions of the if statement are if-then-else and if-then.
- A boolean expression contains conditional and boolean operators and evaluates to true or false.
- Three boolean operators in Java are AND (&&), OR (||), and NOT (!).
- DeMorgan's laws state $!(P \ \&\& \ Q)$ and $!P \ || \ !Q$ are equivalent and $!(P \ || \ Q)$ and $!P \ \&\& \ !Q$ are equivalent.
- Logical operators && and || are evaluated by using the short-circuit evaluation technique.
- A boolean flag is useful in keeping track of program settings.
- An if statement can be a part of the then or else block of another if statement to formulate nested if statements.
- Careful attention to details is important to avoid illogically constructed nested if statements.

- When the equality symbol `==` is used in comparing the variables of reference data type, we are comparing the addresses.
- The `switch` statement is useful for expressing a selection control based on equality testing between data of type `char`, `byte`, `short`, or `int`.
- The `break` statement causes the control to break out of the surrounding `switch` statement (*note*: also from other control statements introduced in Chap. 6).
- The standard classes introduced in this chapter are

<code>java.awt.Graphics</code>	<code>java.awt.Point</code>
<code>java.awt.Color</code>	<code>java.awt.Dimension</code>
- The `java.awt.Graphics` class is used to draw geometric shapes.
- The `java.awt.Color` class is used to set the color of various GUI components.
- The `java.awt.Point` class is used to represent a point in two-dimensional space.
- The `java.awt.Dimension` class is used to represent a bounding rectangle of geometric shapes and other GUI components.
- The enumerated constants provide type safety and increase the program readability.

Key Concepts

<ul style="list-style-type: none"> sequential execution control statements if statement boolean expressions relational operators selection statements nested if statements 	<ul style="list-style-type: none"> increment and decrement operators boolean operators switch statements break statements defensive programming content pane of a frame enumerated constants
---	---

Chapter 5 Exercises

Review Exercises

1. Indent the following if statements properly.
 - a. `if (a == b) if (c == d) a = 1; else b = 1; else c = 1;`
 - b. `if (a == b) a = 1; if (c == d) b = 1; else c = 1;`
 - c. `if (a == b) {if (c == d) a = 1; b = 2; } else b = 1;`
 - d. `if (a == b) {

 if (c == d) a = 1; b = 2; }

 else {b = 1; if (a == d) d = 3;}`
2. Which two of the following three if statements are equivalent?
 - a. `if (a == b)

 if (c == d) a = 1;

 else b = 1;`

```

b. if (a == b) {
    if (c == d) a = 1; }
    else b = 1;
c. if (a == b)
    if (c == d) a = 1;
    else b = 1;

```

3. Evaluate the following boolean expressions. For each of the following expressions, assume x is 10, y is 20, and z is 30. Indicate which of the following boolean expressions are always true and which are always false, regardless of the values for x, y, or z.

```

a. x < 10 || x > 10
b. x > y && y > x
c. (x < y + z) && (x + 10 <= 20)
d. z - y == x && Math.abs(y - z) == x
e. x < 10 && x > 10
f. x > y || y > x
g. !(x < y + z) || !(x + 10 <= 20)
h. !(x == y) && (x != y) && (x < y || y < x)

```

4. Express the following switch statement by using nested if statements.

```

switch (grade) {
    case 10:
        case 9: a = 1;
            b = 2;
            break;

        case 8: a = 3;
            b = 4;
            break;

        default: a = 5;
            break;
}

```

5. Write an if statement to find the smallest of three given integers without using the min method of the Math class.
6. Draw control flow diagrams for the following two switch statements.

```

switch (choice) {
    case 1: a = 0;
        break;

    case 2: b = 1;
        break;

    case 3: c = 2;
        break;

    default: d = 3;
        break;
}

```

```

switch (choice) {
    case 1: a = 0;

    case 2: b = 1;

    case 3: c = 2;

    default: d = 3;
}

```

7. Write an if statement that prints out a message based on the following rules:

If the Total Points Are	Message to Print
≥ 100	You won a free cup of coffee.
≥ 200	You won a free cup of coffee and a regular-size doughnut.
≥ 300	You won a free cup of coffee and a regular-size doughnut and a 12-oz orange juice.
≥ 400	You won a free cup of coffee and a regular-size doughnut and a 12-oz orange juice and a combo breakfast.
≥ 500	You won a free cup of coffee and a regular-size doughnut and a 12-oz orange juice and a combo breakfast and a reserved table for one week.

8. Rewrite the following if statement, using a switch statement.

```

selection = scanner.nextInt( );

if (selection == 0)
    System.out.println("You selected Magenta");

else if (selection == 1)
    System.out.println("You selected Cyan");

else if (selection == 2)
    System.out.println("You selected Red");

else if (selection == 3)
    System.out.println("You selected Blue");

else if (selection == 4)
    System.out.println("You selected Green");

else
    System.out.println("Invalid selection");

```

Level 1 Programming Exercises ★

9. One million is 10^6 and 1 billion is 10^9 . Write a program that reads a power of 10 (6, 9, 12, etc.) and displays how big the number is (Million, Billion, etc.). Display an appropriate message for the input value that has no corresponding word. The table below shows the correspondence between the power of 10 and the word for that number.

Power of 10	Number
6	Million
9	Billion
12	Trillion
15	Quadrillion
18	Quintillion
21	Sextillion
30	Nonillion
100	Googol

10. Write a program `RecommendedWeightWithTest` by extending the `RecommendedWeight` (see Exercise 8 on page 209). The extended program will include the following test:

```

if (the height is between 140cm and 230cm)
    compute the recommended weight
else
    display an error message

```

11. Extend the `RecommendedWeightWithTest` program in Exercise 12 by allowing the user to enter his or her weight and printing out the message You should exercise more if the weight is more than 10 lb over the ideal weight and You need more nourishment if the weight is more than 20 lb under the recommended weight.

Level 2 Programming Exercises ★★

12. Write a program that replies either Leap Year or Not a Leap Year, given a year. It is a leap year if the year is divisible by 4 but not by 100 (for example, 1796 is a leap year because it is divisible by 4 but not by 100). A year that is divisible by both 4 and 100 is a leap year if it is also divisible by 400 (for example, 2000 is a leap year, but 1800 is not).
13. Employees at MyJava Lo-Fat Burgers earn the basic hourly wage of \$7.25. They will receive time-and-a-half of their basic rate for overtime hours. In addition, they will receive a commission on the sales they generate while tending the counter. The commission is based on the following formula:

Sales Volume	Commission
\$1.00 to \$99.99	5% of total sales
\$100.00 to \$299.99	10% of total sales
≥ \$300.00	15% of total sales

Write a program that inputs the number of hours worked and the total sales and computes the wage.

14. Using the `DrawingBoard` class, write a screensaver that displays a scrolling text message. The text messages moves across the window, starting from the right edge toward the left edge. Set the motion type to stationary, so the `DrawingBoard` does not adjust the position. You have to adjust the text's position inside your `DrawableShape`.
15. Define a class called `Triangle` that is capable of computing the perimeter and area of a triangle, given its three sides `a`, `b`, and `c`, as shown below. Notice that side `b` is the base of the triangle.

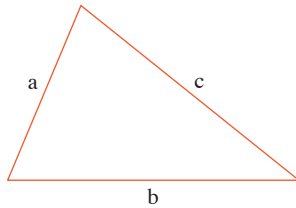

$$\text{Perimeter} = a + b + c$$

$$\text{Area} = \sqrt{s(s - a)(s - b)(s - c)}$$

$$\text{where } s = \frac{a + b + c}{2}$$

The design of this class is identical to that for the Ch5Circle class from Section 5.1. Define a private method `isValid` to check the validity of three sides. If any one of them is invalid, the methods `getArea` and `getPerimeter` will return the constant `INVALID_DIMENSION`.

16. Modify the Ch5RoomWinner class so the three dorm lottery cards are drawn vertically. Make the code for drawing flexible by using the `HEIGHT` constant in determining the placement of three cards.

Note: Please refer to the Hints, Tips, & Pitfalls box on p. 258 about putting a delay in the program so the drawing appears on the window. Also, please refer to the You Might Want to Know box on p. 259 if you want the drawing to remain on the window (instead of disappearing when the window is minimized, for example).

Level 3 Programming Exercises ★★★

17. At the end of movie credits you see the year movies are produced in Roman numerals, for example, MCMXCVII for 1997. To help the production staff determine the correct Roman numeral for the production year, write a program that reads a year and displays the year in Roman numerals.

Roman Numeral	Number
I	1
V	5
X	10
L	50
C	100
D	500
M	1000

Remember that certain numbers are expressed by using a “subtraction,” for example, IV for 4, CD for 400, and so forth.

Development Exercises

For the following exercises, use the incremental development methodology to implement the program. For each exercise, identify the program tasks, create a design document with class descriptions, and draw the program diagram. Map out the development steps at the start. Present any design alternatives and justify your selection. Be sure to perform adequate testing at the end of each development step.

18. MyJava Coffee Outlet (see Exercise 29 from Chap. 3) decided to give discounts to volume buyers. The discount is based on the following table:

Order Volume	Discount
≥ 25 bags	5% of total price
≥ 50 bags	10% of total price
≥ 100 bags	15% of total price
≥ 150 bags	20% of total price
≥ 200 bags	25% of total price
≥ 300 bags	30% of total price

Each bag of beans costs \$5.50. Write an application that accepts the number of bags ordered and prints out the total cost of the order in the following style:

```
Number of Bags Ordered: 173 - $ 951.50
          Discount:
                    20% - $ 190.30
Your total charge is: $ 761.20
```

19. Combine Exercises 18 and 25 of Chap. 3 to compute the total charge including discount and shipping costs. The output should look like the following:

```
Number of Bags Ordered: 43 - $ 236.50
          Discount:
                    5% - $ 11.83
          Boxes Used:
                    1 Large - $1.80
                    2 Medium - $2.00
Your total charge is: $ 228.47
```

Note: The discount applies to the cost of beans only.

20. You are hired by Expressimo Delivery Service to develop an application that computes the delivery charge. The company allows two types of packaging—letter and box—and three types of service—Next Day Priority,

Next Day Standard, and 2-Day. The following table shows the formula for computing the charge:

Package Type	Next Day Priority	Next Day Standard	2-Day
Letter Box	\$12.00, up to 8 oz	\$10.50, up to 8 oz	Not available
	\$15.75 for the first pound. Add \$1.25 for each additional pound over the first pound.	\$13.75 for the first pound. Add \$1.00 for each additional pound over the first pound.	\$7.00 for the first pound. Add \$0.50 for each additional pound over the first pound.

The program will input three values from the user: type of package, type of service, and weight of the package.

21. Ms. Latte's Mopeds 'R Us rents mopeds at Monterey Beach Boardwalk. To promote business during the slow weekdays, the store gives a huge discount. The rental charges are as follows:

Moped Type	Weekday Rental	Weekend Rental
50cc Mopette	\$15.00 for the first 3 h, \$2.50 per hour after the first 3 h.	\$30.00 for the first 3 h, \$7.50 per hour after the first 3 h.
250cc Mohawk	\$25.00 for the first 3 h, \$3.50 per hour after the first 3 h.	\$35.00 for the first 3 h, \$8.50 per hour after the first 3 h.

Write a program that computes the rental charge, given the type of moped, when it is rented (either weekday or weekend), and the number of hours rented.

22. Write a program that teaches children how to read a clock. Input the hour and minute. Accept only numbers between 0 and 12 for hour and between 0 and 59 for minute. Print out an appropriate error message for an invalid input value. Draw a clock that looks something like this:

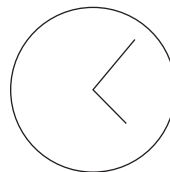

To draw a clock hand, you use the `drawLine` method of the `Graphics` class. The endpoints of the line are determined as follows:

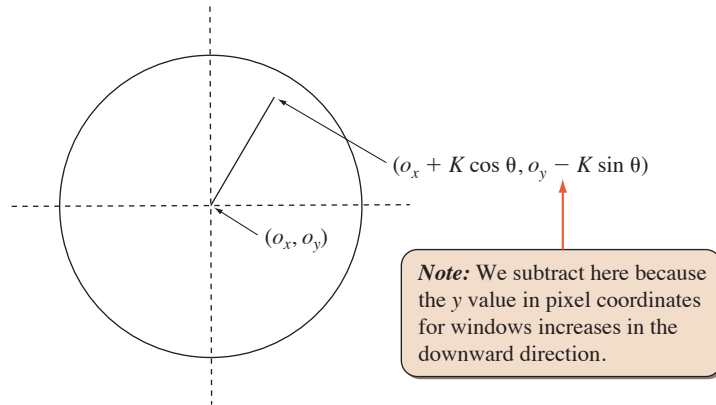

The value for constant K determines the length of the clock hand. Make the K larger for the minute hand than for the hour hand. The angle θ is expressed in radians. The angle θ_{\min} of the minute hand is computed as

$$(90 - \text{Minute} \times 6.0) \frac{\pi}{180}$$

and the angle θ_{hr} of the hour hand is computed as

$$\left(90 - \left(\text{Hour} + \frac{\text{Minute}}{60.0}\right) \times 30.0\right) \frac{\pi}{180}$$

where `Hour` and `Minute` are input values. The values `6.0` and `30.0` designate the degrees for 1 min and 1 h (i.e., the minute hand moves 6 degrees in 1 min and the hour hand moves 30.0 degrees in 1 h). The factor $\pi/180$ converts a degree into the radian equivalent.

You can draw the clock on the content pane of a frame window by getting the content pane's `Graphic` object as described in the chapter. Here's some sample code:

```
import javax.swing.*;
import java.awt.*; //for Graphics
...
JFrame win;
Container contentPane;
Graphics g;
...
win = new JFrame();
win.setSize(300, 300);
win.setLocation(100,100);
win.setVisible(true);
...
contentPane = win.getContentPane();
g = contentPane.getGraphics();
g.drawOval(50,50,200,200);
```

Note: Please refer to the Hints, Tips, & Pitfalls box on p. 258 about putting a delay in the program so the drawing appears on the window. Also, please refer to the You Might Want to Know box on p. 259 if you want the drawing to remain on the window (instead of disappearing when the window is minimized, for example).

23. Extend the application in Exercise 22 by drawing a more realistic, better-looking clock, such as this one:

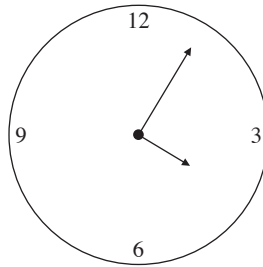

Note: Please refer to the Hints, Tips, & Pitfalls box on p. 258 about putting a delay in the program so the drawing appears on the window. Also, please refer to the You Might Want to Know box on p. 259 if you want the drawing to remain on the window (instead of disappearing when the window is minimized, for example).

24. After starting a successful coffee beans outlet business, MyJava Coffee Outlet is now venturing into the fast-food business. The first thing the management decides is to eliminate the drive-through intercom. MyJava Lo-Fat Burgers is the only fast-food establishment in town that provides a computer screen and mouse for its drive-through customers. You are hired as a freelance computer consultant. Write a program that lists items for three menu categories: entree, side dish, and drink. The following table lists the items available for each entry and their prices. Choose appropriate methods for input and output.

Entree		Side Dish		Drink	
Tofu Burger	\$3.49	Rice Cracker	\$0.79	Cafe Mocha	\$1.99
Cajun Chicken	\$4.59	No-Salt Fries	\$0.69	Cafe Latte	\$1.99
Buffalo Wings	\$3.99	Zucchini	\$1.09	Espresso	\$2.49
Rainbow Fillet	\$2.99	Brown Rice	\$0.59	Oolong Tea	\$0.99

6

Repetition Statements

O b j e c t i v e s

After you have read and studied this chapter, you should be able to

- Implement repetition control in a program using **while** statements.
- Implement repetition control in a program using **do-while** statements.
- Implement a generic loop-and-a-half repetition control statement.
- Implement repetition control in a program using **for** statements.
- Nest a loop repetition statement inside another repetition statement.
- Choose the appropriate repetition control statement for a given task.
- (Optional) Write simple recursive methods.
- Format output values by using the **Formatter** class.

Introduction



T

he selection statements we covered in Chapter 5 alter the control flow of a program. In this chapter we will cover another group of control statements called repetition statements. *Repetition statements* control a block of code to be executed for a fixed number of times or until a certain condition is met. We will describe Java's three repetition statements: *while*, *do-while*, and *for*. Finally, in optional Section 6.11, we will describe recursive methods. A *recursive method* is a method that calls itself. Instead of a repetition statement, a recursive method can be used to program the repetition control flow.

repetition
statements

recursive
method

6.1 The while Statement

Suppose we want to compute the sum of the first 100 positive integers 1, 2, . . . , 100. Here's how we compute the sum, using a *while* statement:

```
int sum = 0, number = 1;
while (number <= 100) {
    sum    = sum + number;
    number = number + 1;
}
```

Let's analyze the *while* statement. The statement follows the general format

```
while ( <boolean expression> )
    <statement>
```

where *<statement>* is either a *<single statement>* or a *<compound statement>*. The *<statement>* of the sample *while* statement is a *<compound statement>* and therefore has the left and right braces. Repetition statements are also called *loop statements*, and we characterize the *<statement>* as the *loop body*. Figure 6.1 shows how this *while* statement corresponds to the general format. As long as the *<boolean expression>* is true, the loop body is executed. Figure 6.2 is a diagram showing the control flow of the sample code.

Let's modify the loop so this time we keep on adding the numbers 1, 2, 3, and so forth, until the sum becomes more than 1,000,000. Here's how we write the *while* statement:

```
int sum = 0, number = 1;
while ( sum <= 1000000 ) {
    sum    = sum + number;
    number = number + 1;
}
```

while state-
ment syntax

loop body

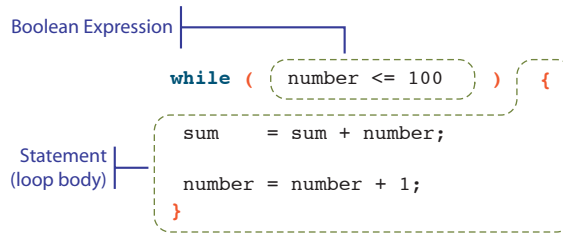

Figure 6.1 Correspondence of the example **while** statement of the general format.

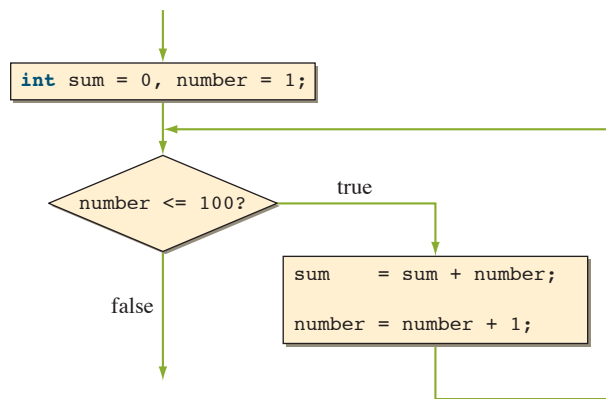

Figure 6.2 A diagram showing the control flow of a **while** statement.

Notice how the <boolean expression> is modified, and it is the only part of the while statement that is modified.

Let's try another example. This time, we compute the product of the first 20 odd integers. (*Note:* The i th odd integer is $2 * i - 1$. For example, the fourth odd integer is $2 * 4 - 1 = 7$.)

```

int product = 1, number = 1, count = 20, lastNumber;
lastNumber = 2 * count - 1;

while (number <= lastNumber) {
    product = product * number;
    number = number + 2;
}

```

count-
controlled loop

The first and the third sample while statements are called *count-controlled loops* because the loop body is executed for a fixed number of times (as if we were counting).

Improving User Interface with a Loop

Now let's study how the repetition control in the program will improve the user interface of the program. In earlier sample programs, we assumed the input data were valid. The programs we have written may produce wrong results or simply stop running if the user enters an invalid value. Assuming that the input values are valid makes the writing of programs easier because we do not have to write code to handle the invalid values. Although it is easier for us to write such programs, it would be an inferior interface from the user's standpoint. Requiring the user to make no mistake in entering input values is too restrictive and not user-friendly. We need to develop programs that are more user-friendly. Imagine you successfully entered 19 values, but on the 20th input value, you mistyped. A user-hostile program would stop, and you would have to run the program again. A more user-friendly program would allow you to reenter a correct 20th value.

All we could have done using a selection statement was either to print out an error message or to set a default value if the user enters an invalid value. In the `inputShapeType` method of the Chapter 5 sample development, for example, if the user enters any invalid value, we set the shape type to `ellipse`. Instead of quitting the program after displaying an error message or continuing the program with a default value, it would be better in general to allow the user to reenter the value until the correct value is entered. We need a repetition control to achieve this.

Let's look at an example. Suppose we want to input a person's age, and the value must be between 0 and 130. We know the age cannot be negative, so the age input must be greater than or equal to 0. We set the upper bound to 130 to take into account the possibility of some long-living human beings in a remote hamlet in Timbuktu. Let's say we will let the user enter the age until a valid age is entered. We can code this repetition control, using a `while` statement:

```
Scanner scanner = new Scanner(System.in);
int age;
System.out.print("Your Age (between 0 and 130): ");
age = scanner.nextInt();
while (age < 0 || age > 130) {
    System.out.println(
        "An invalid age was entered. Please try again.");
    System.out.print("Your Age (between 0 and 130): ");
    age = scanner.nextInt();
}
```

Notice that we included the statements

```
System.out.print("Your Age (between 0 and 130): ");
age = scanner.nextInt();
```

to input the age *before* the `while` statement. Without this input statement, the variable `age` will not have a value when the boolean expression is evaluated for the very

priming read

first time. This reading of a value before the testing is done is called a *priming read*. We will discuss this issue of priming read further in Section 6.4.

As the second example, let's modify the `inputShapeType` method from Section 5.6. To refresh our memory, here's the original code:

```
private DrawableShape.Type inputShapeType( ) {
    System.out.print("Selection: Enter the Shape number\n" +
        "  1 - Ellipse \n" +
        "  2 - Rectangle \n" +
        "  3 - Rounded Rectangle \n");
    int selection = scanner.nextInt();
    DrawableShape.Type type;
    switch (selection) {
        case 1: type = DrawableShape.Type.ELLIPSE;
                break;
        case 2: type = DrawableShape.Type.RECTANGLE;
                break;
        case 3: type = DrawableShape.Type.ROUNDED_RECTANGLE;
                break;
        default: type = DrawableShape.Type.ELLIPSE;
                break;
    }
    return type;
}
```

To allow the user to reenter the value until the valid entry is made, we can modify the method to the following:

```
private int inputShapeType( ) {
    int selection = getSelection();
    DrawableShape.Type type;
    switch (selection) {
        case 1: type = DrawableShape.Type.ELLIPSE;
                break;
        case 2: type = DrawableShape.Type.RECTANGLE;
                break;
        case 3: type = DrawableShape.Type.ROUNDED_RECTANGLE;
                break;
        default: System.out.println
                ("Internal Error: Proceed with Default");
                type = DrawableShape.Type.ELLIPSE;
                break;
    }
}
```

getSelection is defined
after this method.

This default case should
never happen if `getSelection`
is implemented correctly. We
put this here to catch any
internal coding error.

```

    }
    return type;
}
private int getSelection( ) {
    int selection;
    System.out.print("Selection: Enter the Shape number\n" +
        "    1 - Ellipse \n" +
        "    2 - Rectangle \n" +
        "    3 - Rounded Rectangle \n");
    selection = scanner.nextInt();
    while (selection < 1 || selection > 3) {
        System.out.println(
            "An invalid age was entered. Please try
            again.\n");
        System.out.print("Selection: Enter the Shape
            number\n" +
            "    1 - Ellipse \n" +
            "    2 - Rectangle \n" +
            "    3 - Rounded Rectangle \n");
        selection = scanner.nextInt();
    }
    return selection;
}

```

The next example keeps reading in integers and computes their running sum until a negative number is entered.

```

int sum = 0; number;
Scanner scanner = new Scanner(System.in);
System.out.print("Enter integer ");
number = scanner.nextInt();
while (number >= 0) {
    sum = sum + number;
    System.out.print("Enter integer ");
    number = scanner.nextInt();
}

```

The previous three sample while statements are called sentinel-controlled loops. With a *sentinel-controlled loop*, the loop body is executed repeatedly until any one of the designated values, called a *sentinel*, is encountered. The sentinels for the three examples, respectively, are any value between 0 and 130, any value from 1 to 3, and any negative number.

sentinel-
controlled loop

Sample Program with a Loop

Let's write a short sample program that illustrates the use of a while statement. It is a well-known fact that students in college do not get enough sleep, some studying hard while others are enjoying life too much. Which dorm they live in also makes a huge difference, so let's develop a program that determines the average sleeping time of the residents in a given dorm. This information can be made available on the housing office website so the students can make an informed decision on which dorm to choose for the next academic year.

Using Scanner, first we will input the dorm name. Then we loop and input the length of sleep of the residents until the input value of zero is entered. When the input is done, the average sleep time is displayed. We use zero as a sentinel value instead of a negative number such as -1 because we do not want to consider a zero as a valid entry. Here's the program listing:

```

/*
   Chapter 6 Sample Program: Sleep Statistics for Dorm Residents
   File: Ch6SleepStatistics.java
*/

import java.text.*;
import java.util.*;

class Ch6SleepStatistics {

    private Scanner scanner;

    public static void main (String[] args) {
        Ch6SleepStatistics prog = new Ch6SleepStatistics ( );
        prog.start();
    }

    public Ch6SleepStatistics() {
        scanner = new Scanner(System.in);
        scanner.useDelimiter(System.getProperty("line.separator"));
    }

    public void start( ) {

        double sleepHour, sum = 0;
        int    cnt = 0;

        //enter the dorm name
        System.out.print("Dorm name: ");
        String dorm = scanner.next();

        //Loop: get hours of sleep for each resident
        //      until 0 is entered.
        sleepHour = getDouble("Enter sleep hours (0 - to stop:");

```

main

Constructor

start

```

while (sleepHour != 0) {
    sum += sleepHour;
    cnt++;

    sleepHour = getDouble("Enter sleep hours (0 - to stop):");
}

if (cnt == 0) {
    System.out.println ("No Data Entered");
} else {
    DecimalFormat df = new DecimalFormat("0.00");
    System.out.println(
        "Average sleep time for " +
        dorm + " is \n\n      " +
        df.format(sum/cnt) + " hours.");
}
}

private double getDouble(String message) {
    double result;

    System.out.print(message);

    result = scanner.nextDouble();

    return result;
}
}

```



Finding the Greatest Common Divisor

Let's close this section with a slightly more complicated example of using a loop statement. In Section 5.4, we defined the `equals` method for the `Fraction` class. We indicated that the fully functional `equals` method needs to call another method to reduce a fraction to its simplest form (e.g., the simplest form of 16/32 is 1/2). To simplify a fraction, we need to find the greatest common divisor of its numerator and denominator. For example, the greatest common divisor of 16 and 32 is 16. Dividing both the numerator and the denominator by their greatest common denominator will reduce the fraction to its simplest form. Here we will define a method that returns the greatest common divisor of two given arguments. (*Note:* We will develop a full definition of the `Fraction` class in Chapter 7 when we introduce additional concepts on programmer-defined classes.)

We will first provide a brute-force solution (inelegant) and then a clever solution based on the Euclidean algorithm (elegant). The brute-force approach derives

the solution by applying the definition of greatest common divisor directly. Given two positive integers M and N , where $M \leq N$, we find their greatest common divisor by dividing M and N with values from 1 to M . The last integer that divided both M and N perfectly (i.e., there is no remainder), is the greatest common divisor. Consider 24 and 36, for example. The numbers that divide 24 and 36 perfectly are 1, 2, 3, 4, 6, and 12. So the greatest common divisor is 12. The fraction $24/36$ is reduced to its simplest form $2/3$ by dividing 24 and 36 by 12. We can see if a number j divides another number i perfectly by using the modulo arithmetic. If $i \% j == 0$, then j divides i perfectly because the remainder of the division is 0.

Here's the brute-force method:

```
public int gcd_bruteforce(int m, int n) {
    //assume m, n >= 1
    int last = Math.min(m, n);
    int gcd;
    int i = 1;
    while (i <= last) {
        if (m % i == 0 && n % i == 0) {
            gcd = i;
        }
        i++;
    }
    return gcd;
}
```

Now let's study an elegant solution based on the Euclidean algorithm. We begin with an example. Consider two positive integers 44 and 16. We will use the notation $\text{gcd}(a, b)$ to stand for the greatest common divisor of a and b . Notice that $\text{gcd}(44, 16) = 4$. Here's how the Euclidean algorithm works. First divide 44 by 16. The remainder is 12. We have the relation

$$44 = 2 * 16 + 12$$

From this, we can conclude that the greatest common divisor G that divides 44 and 16 must also divide 12. If it doesn't, then we get a contradiction. If a number G can divide 16 perfectly but cannot divide 12 perfectly, then $44 \% G = (2 * 16 + 12) \% G$ will result in a nonzero value. This is a contradiction. So now we can reduce the problem of finding $\text{gcd}(44, 16)$ to $\text{gcd}(16, 12)$. We repeat the process.

$$16 = 1 * 12 + 4$$

Now we reduce the problem to $\text{gcd}(12, 4)$. Since

$$12 = 3 * 4 + 0$$

shows no remainder, we finish the process and return the answer 4 as the greatest common divisor. The sequence of reduction is $\text{gcd}(44, 16) = \text{gcd}(16, 12) = \text{gcd}(12, 4) = 4$.

How do we translate this concept into a working code? Let's map out the sequence of reductions graphically:

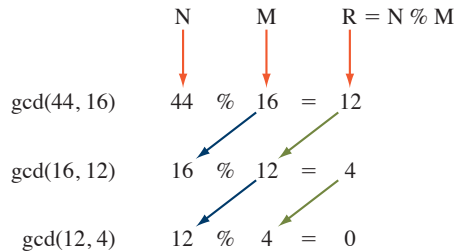

From this diagram, we see that M at one stage becomes N in the next stage and the remainder R becomes M in the next stage. We repeat this process until the remainder becomes 0. The value of M (4 in this example) at the end of the repetition is the greatest common divisor. Here's the `gcd` method that implements this idea:

```
public int gcd(int m, int n) {
    //it doesn't matter which of n and m is bigger
    //this method will work fine either way
    //assume m,n >= 1
    int r = n % m;
    while (r != 0) {
        n = m;
        m = r;
        r = n % m;
    }
    return m;
}
```

Here's how we trace the repetition:

Repetition Count	n	m	r
0	44	16	12
1	16	12	4
2	12	4	0

The first column indicates the number of times the while loop is executed. So the first row shows the values of n , m , and r after zero repetitions, that is, before the while statement is executed. The third row shows the values after the second repetition is

completed. At the point where the third repetition is attempted, the value of r is 0, so the while loop is terminated and the value of m , which is 4, is returned.

The two versions of finding the greatest common denominator produce the correct results. If they both produce the same results, which version shall we prefer? The brute-force method is probably a lot easier to understand, at least initially, because it reflects the definition of greatest common divisor clearly. We always prefer the one that is clearer and easier to understand, but only when their performances are relatively the same. In this example, the Euclidean gcd method far outperforms the gcd_bruteforce method. In other words, the Euclidean gcd method finds the solution much faster than gcd_bruteforce. And the gap widens dramatically when the values of M become large. We will analyze the performance of these two methods experimentally by recording their execution times in Section 6.10.



1. Write a while statement to add numbers 11 through 20. Is this a count-controlled or sentinel-controlled loop?
2. Write a while statement to read in real numbers and stop when a negative number is entered. Is this a count-controlled or sentinel-controlled loop?

6.2 Pitfalls in Writing Repetition Statements

infinite loop

No matter what you do with the while statement (and other repetition statements), make sure that the loop will eventually terminate. Watch out for an *infinite loop* such as this one:

```
int product = 0;
while (product < 500000) {
    product = product * 5;
}
```

Do you know why this is an infinite loop? The variable `product` is multiplied by 5 in the loop body, so the value for `product` should eventually become larger than 500000, right? Wrong. The variable `product` is initialized to 0, so `product` remains 0. The boolean expression `product < 500000` will never be false, and therefore this while statement is an infinite loop. You have to make sure the loop body contains a statement that eventually makes the boolean expression false.

Here's another example of an infinite loop:

```
int count = 1;
while (count != 10) {
    count = count + 2;
}
```

Since the variable `count` is initialized to 1 and the increment is 2, `count` will never be equal to 10. *Note:* In theory, this while statement is an infinite loop, but

overflow error

in programming languages other than Java, this loop will eventually terminate because of an overflow error. An *overflow error* will occur if you attempt to assign a value larger than the maximum value the variable can hold. When an overflow error occurs, the execution of the program is terminated in almost all programming languages. With Java, however, an overflow will not cause program termination. When an overflow occurs in Java, a value that represents infinity (IEEE 754 infinity, to be precise) is assigned to a variable and no abnormal termination of a program will occur. Also, in Java an overflow occurs only with float and double variables; no overflow will happen with int variables. When you try to assign a value larger than the maximum possible integer that an int variable can hold, the value “wraps around” and becomes a negative value.

Whether the loop terminates or not because of an overflow error, the logic of the loop is still an infinite loop, and we must watch out for it. When you write a loop, you must make sure that the boolean expression of the loop will eventually become false.

Another pitfall for you to avoid is the using of real numbers for testing and increment. Consider the following two loops:

imprecise loop counter

```
//Loop 1
double count = 0.0;
while (count != 1.0)
    count = count + 0.3333333333333333;
//there are fifteen 3s

//Loop 2
double count = 0.0;
while (count != 1.0)
    count = count + 0.3333333333333333;
//there are sixteen 3s
```

The second while terminates correctly, but the first while is an infinite loop. Why the difference? Because only an approximation of real numbers can be stored in a computer. We know in mathematics that

$$\frac{1}{3} + \frac{1}{3} + \frac{1}{3}$$

is equal to 1. However, in a computer, an expression such as

$$1.0/3.0 + 1.0/3.0 + 1.0/3.0$$

may or may not get evaluated to 1.0, depending on how precise the approximation is.

The problem here is not that the number $1/3$ is a repeating decimal. A decimal number such as 0.1 cannot be stored precisely in a computer memory either. Consider the following example:

```
double count = 0.0;
while (count != 1.0) {
    count = count + 0.10;
}
```

This repetition statement looks simple enough. We initialize `count` to 0.0 and repeatedly add 0.10 to it, so after 10 repetitions, the loop should terminate. Wrong. The counter variable `count` never becomes equal to 1.0. The closest it gets is 0.9999999999999999. Let's change the loop to

```
double count = 0.0;
while (count <= 1.0) {
    count = count + 0.10;
    System.out.println(count);
}
```

so we can see the values assigned to `count`. Here's the output from this code:

```
0.1
0.2
0.30000000000000004
0.4
0.5
0.6
0.7
0.7999999999999999
0.8999999999999999
0.9999999999999999
1.0999999999999999
```

As these examples illustrate, we should avoid using real numbers as counter variables because of the imprecision.

Things to Remember



Avoid using real numbers for counter variables as much as possible. If you use them, then be aware of the pitfall and ensure that the loop terminates.

off-by-1 error

Another thing to watch out for in writing a loop is the *off-by-1 error*. Suppose we want to execute the loop body 10 times. Does the following code work?

```
count = 1;
while (count < 10 ) {
    ...
    count++;
}
```

No, the loop body is executed 9 times. How about the following code?

```
count = 0;
while (count <= 10 ) {
    ...
    count++;
}
```

No, this time the loop body is executed 11 times. The correct while loop is

```
count = 0;
while (count < 10 ) {
    ...
    count++;
}
```

or

```
count = 1;
while (count <= 10 ) {
    ...
    count++;
}
```

Yes, we can write the desired loop as

```
count = 1;
while (count != 10 ) {
    ...
    count++;
}
```

but this condition for stopping the count-controlled loop is dangerous. We already mentioned about the potential trap of an infinite loop. In summary,

Things to Remember



Watch out for the off-by-1 error (OBOE).

You Might Want to Know



To show you just how commonly the off-by-1 error occurs in everyday life, consider the following two questions. When you want to put a fencepost every 10 ft, how many posts do you need for a 100-ft fence? If it takes 0.5 s for an elevator to rise one floor, how long does it take to reach the fourth floor from the first level? The answers that come immediately are 10 posts and 2 s, respectively. But after a little more thought, we realize the correct answers are 11 posts (we need the final post at the end) and 1.5 s (there are three floors to rise to reach the fourth floor from the first level).

Another common mistake made by beginning programmers is the inclusion of avoidable test in a loop. Consider the following loop statement:

```
int oddSum = 0;
int evenSum = 0;
int num = 1;
```

```
while (num < 1001) {  
    if (num / 2 == 0) { //even #  
        evenSum = evenSum + num;  
    } else { //odd #  
        oddSum = oddSum + num;  
    }  
    num = num + 2;  
}
```

This test can be avoided by writing two loops.

The code computes the sum of even numbers and the sum of odd numbers between 1 and 1000, inclusive. To compute the two sums, the if test is executed 1000 times. Is it necessary? No. We can compute the two sums more efficiently by writing two separate loops:

```
int oddSum = 0;  
int evenSum = 0;  
int num = 1;  
while (num < 1001) {  
    oddSum = oddSum + num;  
    num = num + 2;  
}  
num = 2;  
while (num < 1001) {  
    evenSum = evenSum + num;  
    num = num + 2;  
}
```

We can improve the code even further by using only one loop as follows:

```
int oddSum = 0;  
int evenSum = 0;  
int num = 1;  
while (num < 1001) {  
    oddSum = oddSum + num;  
    evenSum = evenSum + (num + 1);  
    num = num + 2;  
}
```

And here are the points for you to remember in writing a loop.

Things to Remember



The checklist for the repetition control:

1. Make sure the loop body contains a statement that will eventually cause the loop to terminate.
2. Make sure the loop repeats exactly the correct number of times.
3. If you want to execute the loop body N times, then initialize the counter to 0 and use the test condition $\text{counter} < N$ or initialize the counter to 1 and use the test condition $\text{counter} \leq N$.

Quick CHECK ✓

1. Which of the following is an infinite loop?

a. `int sum = 0, i = 0;`
`while (i >= 0) {`
`sum += i;`
`i++;`
`}`

b. `int sum = 0, i = 100;`
`while (i != 0) {`
`sum += i;`
`i--;`
`}`

2. For each of the following loop statements, determine the value of sum after the loop is executed.

a. `int count = 0, sum = 0;`
`while (count < 10) {`
`sum += count;`
`count++;`
`}`

b. `int count = 1, sum = 0;`
`while (count <= 30) {`
`sum += count;`
`count += 3;`
`}`

c. `int count = 0, sum = 0;`
`while (count < 20) {`
`sum += 3*count;`
`count += 2;`
`}`

pretest loop

posttest loop

do-while
statementdo-while
syntax

6.3 | The do-while Statement

The while statement is characterized as a *pretest loop* because the test is done before execution of the loop body. Because it is a pretest loop, the loop body may not be executed at all. The do-while is a repetition statement that is characterized as a *posttest loop*. With a posttest loop statement, the loop body is executed at least once.

The general format for the *do-while statement* is

```
do
    <statement>
while ( <boolean expression> );
```

The <statement> is executed until the <boolean expression> becomes false. Remember that <statement> is either a <single statement> or a <compound statement>. We will adopt the same policy for the if statement; that is, we will use the syntax of <compound statement> even if there is only one statement in the loop body. In other words, we will use the left and right braces even if the loop body contains only one statement.

Let's look at a few examples. We begin with the second example from Section 6.1, which adds the whole numbers 1, 2, 3, . . . until the sum becomes larger than 1,000,000. Here's the equivalent code in a do-while statement:

```
int sum = 0, number = 1;
do {
    sum += number;
    number++;
} while ( sum <= 1000000 );
```

Figure 6.3 shows how this do-while statement corresponds to the general format, and Figure 6.4 is a diagram showing the control flow of this do-while statement.

Let's rewrite the routine that inputs a person's age by using the do-while statement. Here's our first attempt:

```
do {
    System.out.print("Your Age (between 0 and 130): ");
    age = scanner.nextInt();
} while (age < 0 || age > 130);
```

It works, but unlike the version using the while statement, the code does not display an error message. The user could be puzzled as to why the input is not accepted. Suppose the user tries to enter 130 but actually enters 139 unintentionally. Without an error message to inform the user that the input was invalid, he or she may wonder why the program is asking again for input. A program should not be confusing to the user. We must strive for a program with a user-friendly interface.

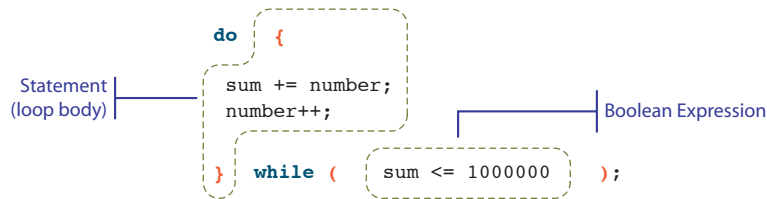

Figure 6.3 Correspondence of the example **do-while** statement to the general format.

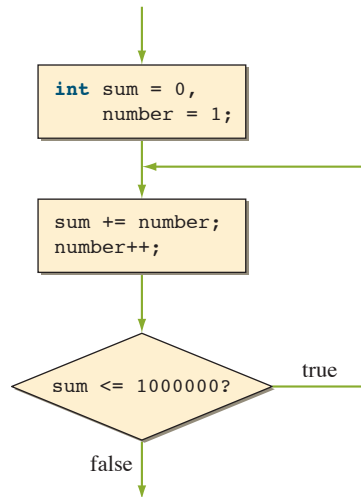

Figure 6.4 A diagram showing the control flow of the **do-while** statement.

To display an error message, we rewrite the **do-while** statement as

```
do {
    System.out.print("Your Age (between 0 and 130): ");
    age = scanner.nextInt();
    if (age < 0 || age > 130) {
        System.out.println(
            "An invalid age was entered. Please try again.");
    } while (age < 0 || age > 130);
}
```

This code is not as good as the version using the **while** statement. Do you know why? This **do-while** statement includes an **if** statement inside its loop body. Since the loop body is executed repeatedly, it is important not to include any extraneous statements. The **if** statement is repeating the same boolean expression of the **do-while**. Duplicating the testing conditions tends to make the loop statement harder to understand. For this example, we can avoid the extra test inside the loop

boolean variable and loop

body and implement the control flow a little more clearly by using a while statement. In general, the while statement is more frequently used than the do-while statement. However, the while statement is not universally better than the do-while statement. It depends on a given task, and our job as programmers is to use the most appropriate one. We choose the repetition statement that implements the control flow clearly, so the code is easy to understand.

When you have multiple conditions to stop the loop and you need to execute different responses to each of the multiple conditions, then the use of boolean variables often clarifies the meaning of the loop statement. Consider the following example. Suppose we need to compute the sum of odd integers entered by the user. We will stop the loop when the sentinel value 0 is entered, an even integer is entered, or the sum becomes larger than 1000. Without using any boolean variables, we can write this loop as follows:

```
sum = 0;
do {
    System.out.print("Enter integer: ");

    num = scanner.nextInt();

    if (num == 0) { //sentinel
        System.out.print("Sum = " + sum);
    } else if (num % 2 == 0) //invalid data
        System.out.print("Error: even number was entered");
    } else {
        sum += num;
        if (sum > 1000) { //pass the threshold
            System.out.print("Sum became larger than 1000");
        }
    }
} while ( !(num % 2 == 0 || num == 0 || sum > 1000) );
```

The ending condition is tricky. We need to stop the loop if any one of the three conditions `num % 2 == 0`, `num == 0`, or `sum > 1000` is true. So we repeat the loop when none of the three conditions are true, which is expressed as

```
!(num % 2 == 0 || num == 0 || sum > 1000)
```

We can also state the condition as

```
do {
    ...
} while( num % 2 != 0 && num != 0 && sum <= 1000 );
```

Note:
!(a || b) is equal to (!a &&!b)

which means “repeat the loop while num is odd and num is not 0 and sum is less than or equal to 1000.” Regardless of the method used, the test conditions are duplicated inside the loop body and in the boolean expression.

Now, by using a boolean variable, the loop becomes

```

boolean repeat = true;
sum = 0;
do {
    System.out.print("Enter integer: ");

    num = scanner.nextInt();

    if (num % 2 == 0) { //invalid data
        System.out.print("Error: even number was entered");
        repeat = false;
    } else if (num == 0) { //sentinel
        System.out.print("Sum = " + sum);
        repeat = false;
    } else {
        sum += num;
        if (sum > 1000) { //pass the threshold
            System.out.print("Sum became larger than 1000");
            repeat = false;
        }
    }
} while ( repeat );

```

Note: `continue` is a reserved word in Java, while `repeat` is not.

Set the variable to `false` so the loop terminates.

This loop eliminates duplicate tests. The use of boolean variables is helpful in making loop statements readable, especially when the loop has multiple stop conditions.

As the last example of this section, here's the `gcd` method implemented by using the `do-while` statement (we'll call it `gcd_do` to differentiate it from other versions):

```

public int gcd_do(int m, int n) {

    //it doesn't matter which of n and m is bigger
    //this method will work fine either way

    //assume m,n >= 1

    int r;

    do {

        r = n % m;

        n = m;

        m = r;

    } while (r != 0);

    return n; //NOTE: we're returning n, not m
            //      because m == r == 0 after the loop
}

```

Quick CHECK



1. Write a do-while loop to compute the sum of the first 30 positive odd integers.
2. Rewrite the following while loops as do-while loops.

```
a. int count = 0, sum = 0;
   while ( count < 10 ) {
       sum += count;
       count++;
   }
```

```
b. int count = 1, sum = 0;
   while ( count <= 30 ) {
       sum += count;
       count += 3;
   }
```

6.4 | Loop-and-a-Half Repetition Control

When we compare the while and do-while repetition control, we realize the key difference is the position of the testing relative to the loop body. The while loop tests the terminating condition before the loop body, but the do-while tests the terminating condition after the loop body. What happens when we want to test the terminating condition right in the middle of the loop body? Such repetition control can be characterized as a *loop-and-a-half control* because only the top half of the loop body is executed for the last repetition. Do we ever need such a looping statement?

loop-and-a-half
control

Consider the following while loop with the priming read:

```
String name;

System.out.print("Your name: ");

name = scanner.next();

while (name.length() == 0) {

    System.out.println("Invalid entry. " +
        "You must enter at least one character.");

    System.out.print("Your name: ");

    name = scanner.next();

}
```

Because the while loop tests the terminating condition at the beginning, we must place some statements before the loop to ensure the condition can be evaluated. The same statements are repeated inside the loop, so the terminating condition can be evaluated correctly after each repetition. This duplication of the statements can become tedious depending on what is to be duplicated. We can avoid the duplication

of code with the loop-and-a-half structure. Java does not support any special reserved word for the loop-and-a-half repetition control. Rather, we implement it using the `while`, `if`, and `break` reserved words. Here's how we express the sample priming read while loop in a loop-and-a-half format:

```
String name;

while (true) {
    System.out.print("Your name: ");

    name = scanner.next();

    if (name.length() == 0) break;

    System.out.println("Invalid entry. " +
        "You must enter at least one character. ");
}
```

If the test evaluates to `true`, then jump out of the loop.

We have seen the use of the `break` statement in Chapter 5. Execution of the `break` statement causes the control to jump out of the switch statement. We can in fact use the `break` statement with any control statement. In this example, the `break` statement causes the control to jump out of the `while` statement. Since it is executed when the `if` test is true, the `String` variable `name` contains at least one character. If the test fails, the next statement is executed and the control loops back to the top of the `while` loop. Expressing this control flow in a flowchart will result in the one shown in Figure 6.5.

There are two concerns when we use the loop-and-a-half control. The first is the danger of an infinite loop. Notice the boolean expression of the `while` statement is simply `true`, which, of course, will always evaluate to `true`. So, if we forget to include an `if` statement to break out of the loop, it will end up in an infinite loop.

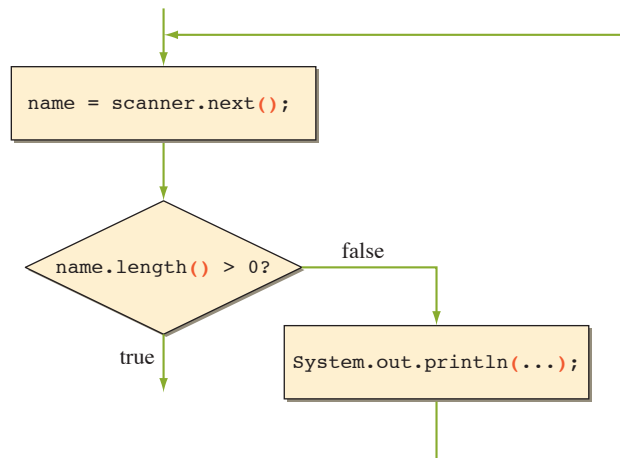

Figure 6.5 A diagram showing the control flow of a loop-and-a-half statement.

The second concern is the complexity of multiple exit points. It is possible to write a loop-and-a-half statement with multiple break statements, something like this:

```
while (true) {
    ...
    if (<condition 1>) break;
    ...
    if (<condition 2>) break;
    ...
    if (<condition 3>) break;
    ...
}
```

one-entry
one-exit
control

It gets tricky to write a correct control loop with multiple exit points. One of the frequently cited software engineering practices for reliable code is to enforce the *one-entry one-exit control* flow. In other words, there is one entry point to the loop and one exit point from the loop. With the standard while and do-while with no break statements inside the loop, we have this one-entry one-exit control flow. A loop-and-a-half control with multiple break statements, however, violates it.

If we watch out for these two points, a loop-and-a-half control can be quite handy and can make the code more readable. Here are the things to remember in using the loop-and-a-half control.

Things to Remember



The checklist for the loop-and-a-half control:

1. To avoid an infinite loop, make sure the loop body contains at least one *if* statement that breaks out of the loop.
2. To keep the control simple and easy to read, avoid using multiple *if* statements that break out of the loop.
3. Make sure the loop is short to keep the control logic as self-evident as possible. (Notice this applies to all loop statements, but more so for a loop-and-a-half.)

In this textbook, we will be using loop-and-a-half statements whenever appropriate, that is, whenever it makes the code more readable and clearer. Before we conclude this section, here's another loop-and-a-half statement. The loop evaluates the average score, and it terminates when the input is a negative number.

```
int    cnt = 0;
double score, sum = 0.0;

while (true) {

    System.out.print("Enter score: ");

    score = scanner.nextDouble();
```

```

    if (score < 0) break;
    sum += score;
    cnt++;
}

if (cnt > 0) {
    avg = sum / cnt;
} else {
    //error: no input
}

```

Again, we will use the gcd method as the last example. Here's the gcd method using the loop-and-a-half repetition control (we'll call this version gcd_LaH):

```

public int gcd_LaH(int m, int n) {

    //it doesn't matter which of n and m is bigger
    //this method will work fine either way

    //assume m,n >= 1

    int r;

    while (true) {

        r = n % m;

        if (r == 0) break;

        n = m;

        m = r;

    }

    return m;

}

```



1. Translate the following while loop to a loop-and-a-half format.

```

int sum = 0, num = 1;
while (num <= 50) {
    sum += num;
    num++;
}

```

2. Translate the following do-while loop to a loop-and-a-half format.

```

int sum = 0, num = 1;
do {
    sum += num;
    num++;
} while (sum <= 5000);

```

6.5 | The for Statement

The for statement is the third repetition control statement and is especially suitable for count-controlled loops. Let's begin with an example. The following code computes the sum of the first 100 positive integers:

```
int i, sum = 0;
for (i = 1; i <= 100; i++) {
    sum += i; //equivalent to sum = sum + i;
}
```

The general format of the for statement is

```
for ( <initialization>; <boolean expression>; <update> )
    <statement>
```

Figure 6.6 shows the correspondence of the sample code above to the general format. The diagram in Figure 6.7 shows how this statement is executed. The variable *i* in the statement is called a *control variable*, and it keeps track of the number

control variable

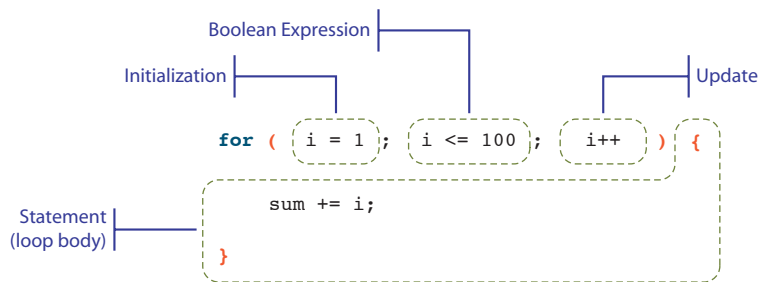

Figure 6.6 Correspondence of the example for statement to the general format.

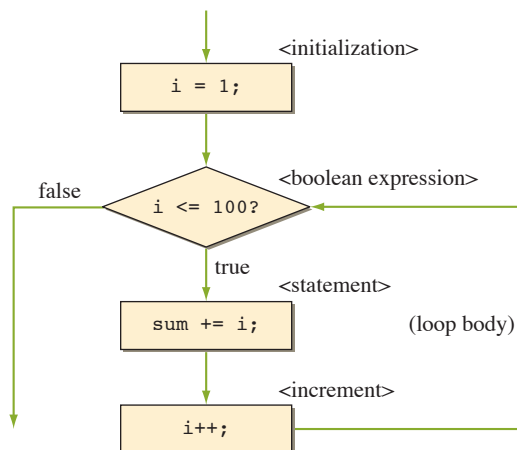

Figure 6.7 A diagram showing the control flow of the example for statement.

of repetitions. In the sample code, the control variable *i* is first initialized to 0, and immediately the boolean expression is evaluated. If the evaluation results in true, the loop body is executed. Otherwise, the execution of the for statement is terminated, and the control flows to the statement following this for statement. Every time the loop body is executed, the increment operator (*i++*) is executed and then the boolean expression is evaluated.

The <initialization> component also can include a declaration of the control variable. We can do something like this

```
for (int i = 1; i <= 100; i++)
```

instead of

```
int i;  
for (i = 0; i < 10; i++)
```

The control variable may be initialized to any value, although it is almost always 0 or 1.

The <update> expression in the example increments the control variable by 1. We can increment it with values other than 1, including negative values, for example,

```
for (int i = 0; i < 100; i += 5) //i = 0, 5, 10, . . . , 95  
for (int j = 2; j < 40; j *= 2) //j = 2, 4, 8, 16, 32  
for (int k = 100; k > 0; k--) //k = 100, 99, 98, 97, . . . , 1
```

Notice that the control variable appears in all three components: <initialization>, <conditional expression>, and <update>. A control variable does not have to appear in all three components, but this is the most common style. Many other variations are allowed for these three components, but for novices, it is safer to use this style exclusively.

Let's look at an example from physics. When an object is dropped from height *H*, the position *P* of the object at time *t* can be determined by the formula

$$P = -16t^2 + H$$

For example, if a watermelon is dropped from the roof of a 256-ft-high dormitory, it will drop like this:

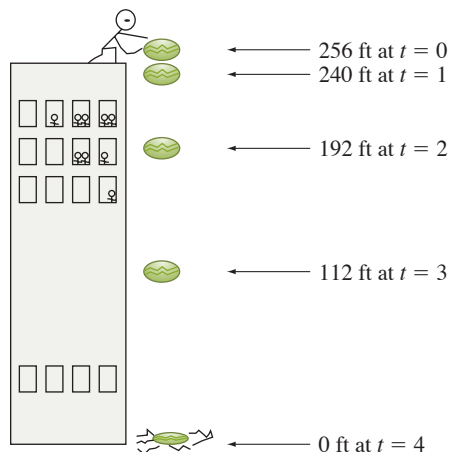

We can use a for statement to compute the position P at time t . We will input the initial height and compute the position every second. We repeat this computation until the watermelon touches the ground. The time the watermelon touches the ground is derived by solving for t when $P = 0$.

$$0 = -16t^2 + H$$

$$t = \sqrt{\frac{H}{16}}$$

```

/*
  Chapter 6 Sample Program: Dropping a Watermelon
  File: Ch6DroppingWaterMelon.java
*/

import java.util.*;

class Ch6DroppingWaterMelon {

    public static void main( String[] args ) {

        double initialHeight,
               position,
               touchTime;

        Scanner scanner = new Scanner(System.in);

        System.out.print("Initial Height:");
        initialHeight = scanner.nextDouble();

        touchTime      = Math.sqrt(initialHeight / 16.0);
        touchTime      = Math.round(touchTime * 10000.0) / 10000.0;
                       //convert to four decimal places

        System.out.println("\n\n   Time t       Position at Time t \n");

        for (int time = 0; time < touchTime; time++) {
            position = -16.0 * time*time + initialHeight;
            System.out.print("   " + time);
            System.out.println("           " + position);
        }

        //print the last second
        System.out.println("   " + touchTime + "           0.00");
    }
}

```

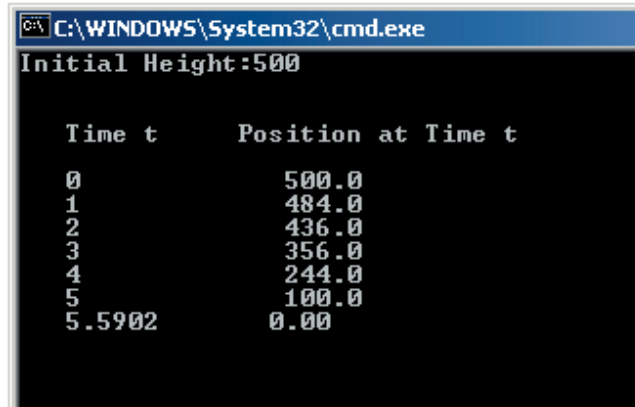

Figure 6.8 The positions of a watermelon dropped from a height of 500 ft.

Running the program with the input value 500.0 for the initial height and using System.out as output will result in the window shown in Figure 6.8.

You Might Want to Know



Java 5.0 introduces a new form of the **for** statement. There is no formal name for the newest **for** loop, but the name *for-each loop* is used most often. The for-each loop is a very convenient way to iterate over a collection of items. We will introduce the new **for** loop in Chapter 10 and see its use in the data structure chapters.

Hints, & Tips, Pitfalls



The format for the **for** loop presented in this section is the most basic version. The Java language allows more complex **for** statements. For instance, the **<initialization>** and **<update>** parts of the **for** statement are not limited to a single statement. They can contain zero or more statements. The following two statements, for example, are both valid.

```
int val, i, j;
for (i = 0, j = 100, val = 0; //init
     i < 100 && j > 50; //bool expr
     i++, j--) { //increment
    val += i - j;
}
System.out.println("val = " + val);
Scanner scanner = new Scanner(System.in);
```

```

int sum, cnt, n;
for (sum = 0, cnt = 0;    //init
    cnt < 10;            //bool expr
    //increment
    System.out.print("Enter number: "),
    n = scanner.nextInt(),
    sum += n,
    cnt++ ) {
}

```

Do you ever need to write such intricate **for** statements? Most likely, no. The two sample statements can be written more clearly and logically in other ways. We strongly recommend that you stick to the basic, and most logical, form of the **for** statement.

Hints, & Tips, Pitfalls



We have introduced three forms of repetition statements—**while**, **do-while**, and **for**. They are equivalent in their expressive power. In other words, a loop written in one form of repetition statement can be written by using the other two forms of repetition statement. Although they are equivalent, in many cases one form would express the repetition control in a more natural and direct manner. It is your responsibility as a programmer to implement the repetition control using the most appropriate form.

Quick CHECK ✓

- Write a **for** loop to compute the following.
 - Sum of 1, 2, . . . , 100
 - Sum of 2, 4, . . . , 500
 - Product of 5, 10, . . . , 50
- Rewrite the following **while** loops as **for** statements.
 - ```

int count = 0, sum = 0;
while (count < 10) {
 sum += count;
 count++;
}

```
  - ```

int count = 1, sum = 0;
while ( count <= 30 ) {
    sum += count;
    count += 3;
}

```

6.6 Nested for Statements

In many processing tasks, we need to place a for statement inside another for statement. In this section, we introduce a simple nested for statement. We will see more examples of nested for statements later in the book, especially in Chapter 10 on array processing.

Suppose we want to display a quick reference table for clerks at the Rugs-R-Us carpet store. The table in Figure 6.9 lists the prices of carpets ranging in size from 11×5 ft to 20×25 ft (using `System.out` for output). The width of a carpet ranges from 11 to 20 ft with an increment of 1 ft. The length of a carpet ranges from 5 to 25 ft with an increment of 5 ft. The unit price of a carpet is \$19 per square foot.

We use a nested for statement to print out the table. Let's concentrate first on printing out prices. We'll worry about printing out length and width values later. The following nested for statement will print out the prices:

```

int         price;
for (int width = 11; width <= 20; width++) {
    for (int length = 5; length <= 25; length += 5) {
        price = width * length * 19; // $19 per sq ft.
        System.out.print(" " + price);
    }
    //finished one row; now move on to the next row
    System.out.println("");
}

```

Diagram illustrating the nested for loops: The outer for loop (width) is shown as a large blue bracket on the left, and the inner for loop (length) is shown as a smaller blue bracket nested inside it.

Length

	5	10	15	20	25
11	1045	2090	3135	4180	5225
12	1140	2280	3420	4560	5700
13	1235	2470	3705	4940	6175
14	1330	2660	3990	5320	6650
15	1425	2850	4275	5700	7125
16	1520	3040	4560	6080	7600
17	1615	3230	4845	6460	8075
18	1710	3420	5130	6840	8550
19	1805	3610	5415	7220	9025
20	1900	3800	5700	7600	9500

Width

Figure 6.9 The price table for carpets ranging in size from 11×5 ft to 20×25 ft whose unit price is \$19 per square foot.

The outer for statement is set to range from the first row (width = 11) to the last row (width = 20). For each repetition of the outer for, the inner for statement is executed, which ranges from the first column (length = 5) to the fifth column (length = 25). The loop body of the inner for computes the price of a single carpet size and prints out this price. So the complete execution of the inner for, which causes its loop body to be executed 5 times, completes the output of one row. The following shows the sequence of values for the two control variables.

width	length	
11	5	
	10	
	15	
	20	
	25	← Completes the printing of the first row
12	5	
	10	
	15	
	20	
	25	← Completes the printing of the second row
13	5	
	10	
	⋮	

Now let's add the code to print out the row and column index values for width and length.

```

int price;

System.out.print("  5 10 15 20 25");
System.out.print("\n\n");
for (int width = 11; width <= 20; width++) {
    System.out.print(width + " ");

    for (int length = 5; length <= 25; length += 5) {
        price = width * length * 19; // $19 per sq ft.
        System.out.print("  " + price);
    }

    //finished one row; now move on to the next row
    System.out.print("\n");
}

```

Added statements

The next improvement is to include the labels `Width` and `Length` in the output. This enhancement is left as Exercise 19 at the end of the chapter. Also, in the example, literal constants are used for the carpet sizes and the increment value on length (11, 20, 5, 25, and 5), but in a real program, named constants should be used.



1. What will be the value of `sum` after the following nested for loops are executed?

a.

```
int sum = 0;
for (int i = 0; i < 5; i++) {
    sum = sum + i;
    for (int j = 0; j < 5; j++) {
        sum = sum + j;
    }
}
```

b.

```
int sum = 0;
for (int i = 0; i < 5; i++) {
    sum = sum + i;
    for (int j = i; j < 5; j++) {
        sum = sum + j;
    }
}
```

2. What is wrong with the following nested for loop?

```
int sum = 0;
for (int i = 0; i < 5; i++) {
    sum = sum + i;
    for (int i = 5; i > 0; i--) {
        sum = sum + j;
    }
}
```

6.7 Formatting Output

In the table shown in Figure 6.10, the values are aligned very nicely. We purposely selected the unit price and the ranges of width and length so that the table output would look good. Notice that the output values are all four-digit numbers. Realistically, we cannot expect output values to be so uniform. Let's change the unit price to \$15 and the range of widths to 5 through 14 ft and see what happens. The result is shown in Figure 6.10, which is not as neat as the previous output. What we need is a way to format the output so the values are printed out with the proper alignment.

In the code, we used the fixed number of spaces between the values, and it worked because the output values have the same number of digits. To align the values with a varying number of digits, we must vary the number of spaces in front of the values, as shown in Figure 6.11.

The basic idea of formatted output is to allocate the same amount of space for the output values and align the values within the allocated space. We call the space

	5	10	15	20	25
5	375	750	1125	1500	1875
6	450	900	1350	1800	2250
7	525	1050	1575	2100	2625
8	600	1200	1800	2400	3000
9	675	1350	2025	2700	3375
10	750	1500	2250	3000	3750
11	825	1650	2475	3300	4125
12	900	1800	2700	3600	4500
13	975	1950	2925	3900	4875
14	1050	2100	3150	4200	5250

Figure 6.10 The price table for carpets with \$15 per square foot and width ranging from 5 through 14 ft.

```

-----3|-----34|---5684|-----98|---231|
---445|---339|---234|---453|---3444|

```

Each value occupies six spaces. If the value has three digits, we put three blank spaces in front. If the value has four digits, we put two blank spaces in front, and so forth.

Figure 6.11 How to place a varying number of spaces to align the output values. Hyphen is used here to indicate the blank space.

field

occupied by an output value the *field* and the number of characters allocated to a field its *field width*. In Figure 6.11, the field width is 6.

We have already used two formatting classes—`DecimalFormat` and `SimpleDateFormat`—introduced in Chapters 2 and 3. The most recent version of Java SDK 1.5 has a new general-purpose formatting class called `Formatter` that includes the functionalities of `DecimalFormat` and `SimpleDateFormat`. For its power, using the `Formatter` class is slightly more complicated than using the `DecimalFormat` and `SimpleDateFormat` classes.

To format output using `Formatter`, first we create its instance by passing the destination of the output as an argument. Suppose we want to send the formatted output to `System.out`; then we create a `Formatter` object as follows:

```
Formatter formatter = new Formatter(System.out);
```

Next we call its `format` method to output the formatted values. For example, to output an integer with the field width of 6, we write

```
int num = 467;
formatter.format("%6d", num);
```

control string

The string `%6d` is called a *control string*, and it directs how the formatting will take place. The value `6` specifies the field width, and the control character `d` indicates the output value is a decimal integer.

The general syntax for the format method is as follows:

```
format(<control string>, <expr1>, <expr2>, ...)
```

The first argument is the control string, and it is followed by zero or more expressions. The control string may include the actual output string in addition to control values. For example, the statement

```
int num1, num2, num3;

num1 = 34;
num2 = 9;
num3 = num1 + num2;

formatter.format("%3d + %3d = %5d", num1, num2, num3);
```

will output

```
34 + 9 = 43
```

Figure 6.12 shows how the control values are matched left to right against the arguments. The figure also illustrates how the noncontrol values (such as `+` and `=` symbols) are output to the destination.

We can change the default left-to-right argument matching by including the argument index in the control string. The arguments can be indexed as `1$`, `2$`, and so forth. For example, the output of

```
formatter.format("%3$3d is the sum of %2$3d and %1$3d",
                num1, num2, num3);
```

will be

```
43 is the sum of 9 and 34
```

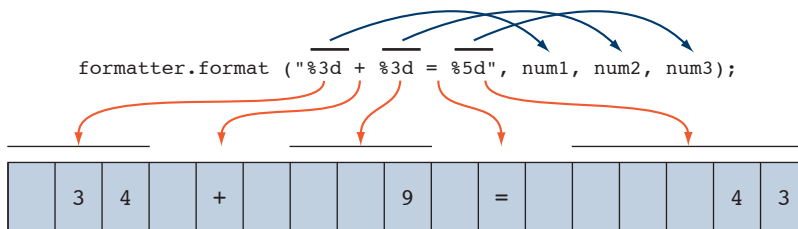

Figure 6.12 The control values are matched left to right.

To format real numbers, we include the number of decimal places along with the field width in the following format:

```
%<field width> . <decimal places> f
```

The control letter `f` designates formatting a floating-point number. Here's an example to format 345.9867 using a field of width 15 and two decimal places:

```
formatter.format("%15.3f", 345.9867);
```

To format a string, we use the control letter `s`. Here's an example:

```
String name = "John";
formatter.format("Hello, %s. Nice to meet you.", name);
```

The output will be

```
Hello, John. Nice to meet you.
```

We can also use the `format` method to format the date information. We use the control letter `t` for formatting an instance of `GregorianCalendar` or `Date`. The control letter `t` must be followed by another control letter that designates the formatting of the components of the date information, such as month, day, or year. For example, if we write

```
GregorianCalendar day = new GregorianCalendar(1776, 6, 4);
formatter.format("%1$tB %1$te, %1$tY", day);
```

the output will be

```
July 4, 1776
```

The date control letter `B` designates the full month name, `e` designates the day in two digits, and `Y` designates the year in four digits. For other data control letters, please consult the documentation. Notice that there is only one output argument, and it is referred to as `1$` three times in the control string.

The use of the `Formatter` class gives us the most control over the formatting, but for common output formatting, we can do it by using the `format` method of `System.out` or the `String` class instead. (In this section, we presented only a subset of common formatting.) For example, the following code

```
System.out.format("%5s is %3d years old", "Bill", 20);
```

is equivalent to

```
Formatter formatter = new Formatter(System.out);
formatter.format("%5s is %3d years old", "Bill", 20);
```

The screenshot shows a Windows command prompt window with the title bar 'C:\WINDOWS\System32\cmd.exe'. The window contains a table of carpet prices. The table has 6 columns: a row index (5-14) and five price values (375, 450, 525, 600, 675, 750, 825, 900, 975, 1050, 1125, 1350, 1500, 1650, 1800, 2025, 2250, 2475, 2700, 3000, 3150, 3300, 3600, 3900, 4125, 4250, 4500, 4875, 5250). The numbers are right-aligned in each column.

	5	10	15	20	25
5	375	750	1125	1500	1875
6	450	900	1350	1800	2250
7	525	1050	1575	2100	2625
8	600	1200	1800	2400	3000
9	675	1350	2025	2700	3375
10	750	1500	2250	3000	3750
11	825	1650	2475	3300	4125
12	900	1800	2700	3600	4500
13	975	1950	2925	3900	4875
14	1050	2100	3150	4200	5250

Figure 6.13 Carpet price table of Figure 6.11 with proper alignment.

(Note: For those who are familiar with C or C++, there's a method named `printf` defined for `System.out` that works exactly the same as the `format` method. However, Java's `printf` is similar but not identical to the one in C or C++.)

Instead of printing out, it is possible to create a formatted string and assign it to a variable with the `format` method of the `String` class. Here's an example:

```
String outputStr
    = String.format("%3d + %3d = %5d", num1, num2, num3);
```

We close the section with a program that produces the carpet price table with proper alignment for the range of values used in producing the table in Figure 6.10. Running this program will produce the table shown in Figure 6.13.

```
/*
Chapter 6 Sample Program: Sample formatting statements
File: Ch6CarpetPriceTableWithFormat.java
*/

class Ch6CarpetPriceTableWithFormat {
    public static void main (String[] args) {

        int price;

        //print out the column labels
        System.out.print("   "); //put three blank spaces first

        for (int colLabel = 5; colLabel <=25; colLabel += 5) {
            System.out.format("%8d", colLabel);
        }
    }
}
```

```

System.out.println("");
System.out.println("");

//print out rows of prices
for (int width = 5; width <= 14; width++) {

    System.out.format("%3d", width);

    for (int length = 5; length <= 25; length += 5) {
        price = width * length * 15;

        System.out.format("%8d", price);
    }

    //finished one row; now move on to the next row
    System.out.println("");
}

System.out.println("");
System.out.println("");
}
}

```



1. Determine the output of the following code.

```

System.out.format("%3d + %3d = %3d", 1, 2, 3);
System.out.format("%tY", new Date());
System.out.format("%2$s,%1$s", "John", "Smith");

```

2. What's wrong with the following code?

```

Formatter f = new Formatter( );
f.format("%8.3f", 232.563);

```

6.8 | Loan Tables

The LoanCalculator program computed the monthly and total payments for a given loan amount, annual interest rate, and loan period. To see the monthly payment for the same loan amount and loan period but with a different interest rate, we need to repeat the calculation, entering the three values again. To illustrate the use of the concepts introduced in this chapter, let's design a program that generates a loan table (similar to the carpet price table) for a given loan amount so we can compare different monthly payments easily and quickly. The columns of the table are the loan periods in number of years (5, 10, 15, 20, 25, 30), and the rows are interest rates ranging from 6 to 10 percent in increments of 0.25.

In this section, we provide a discussion of the relevant methods only. Let's begin with a design of the topmost start method of the top-level controller class. The start method can be expressed as

```

tell the user what the program does;

prompt the user "Do you want to generate a loan table?";
while (the user says YES) {
    input the loan amount;
    generate the loan table;

    prompt the user "Do you want another loan table?";
}

```

pseudocode

The start method is expressed in pseudocode. *Pseudocode* is an informal language we often use to express an algorithm. Pseudocode is useful in expressing an algorithm without being tied down to the rigid syntactic rules of a programming language. We can express a simple algorithm in the actual programming language statements, but for a more complex algorithm, especially those involving nonsequential control flow logic, pseudocode is very helpful in expressing the algorithm concisely and clearly. Whenever appropriate, we will use pseudocode to express more complex algorithms in the remainder of the book.

Translating the pseudocode into Java code will result in

```

private static enum Response {YES, NO}

public void start( ) {
    Response response;

    describeProgram();

    response = prompt("Generate a loan table?");

    while (response == Response.YES) {

        loanAmount = getLoanAmount(); //get input
        generateLoanTable(loanAmount); //generate table

        response = prompt("Generate another loan table?");
    }
}

private Response prompt(String question) {
    String input;

    Response response = Response.NO;

    System.out.print(question + " (Yes - y; No - n): ");

    input = scanner.next(); _____ scanner is created in a
                                         constructor
}

```

```

    if (input.equals("Y") || input.equals("y")) {
        response = Response.YES;
    }
    return response;
}

```

Notice how the actual start method is almost as easy to read as the pseudocode. By using objects and well-designed (sub)methods, we can express methods that are as easy to read as pseudocode.

The `describeProgram` method tells the user what the program does if the user requests it. The `getLoanAmount` method gets the loan amount from the user. The method will allow the user to enter the loan amount between 100.0 and 500000.0. The `generateLoanTable` method generates the loan table, which we explain in detail next.

We use a nested loop to generate the table. Both the inner and outer loops are count-controlled loops. The loop for columns (years) will range from 5 to 30 with an increment of 5 and the loop for rows (rates) will range from 6.0 to 10.0 with an increment of 0.25. So the nested loop can be written as follows:

```

private static final int BEGIN_YEAR = 5;
private static final int END_YEAR   = 30;
private static final int YEAR_INCR  = 5;

private static final double BEGIN_RATE = 6.0;
private static final double END_RATE   = 10.0;
private static final double RATE_INCR  = 0.25;

...

for (double rate = BEGIN_RATE; rate <= END_RATE;
     rate += RATE_INCR){

    for (int year = BEGIN_YEAR; year <= END_YEAR;
         year += YEAR_INCR){

        ...

        //compute and display the monthly loan payment
        //for a given year and rate
    }
}
}

```

Notice the outer loop is using `double` as the loop counter, something we discouraged in Section 6.2. In this particular case, with the increment value of 0.25, there will be no problem because this value can be represented precisely in computer memory. Moreover, the terminating condition `rate <= END_RATE` guarantees that the loop will terminate eventually if we keep adding `RATE_INCR` to `rate`.

To compute the monthly loan payment, we simply reuse the `Loan` class we defined in Chapter 4 as follows:

```

double amount = ... ;
double rate    = ... ;
int    period  = ... ;

```

```

Loan loan = new Loan( );

double monthlyPayment
    = loan.getMonthlyPayment(amount, rate, period);

```

This is the power of object-oriented programming. Because a single well-defined task of loan computation and nothing else is coded in the `Loan` class, we are able to reuse it here easily. What would happen had we not designed the `Loan` class? It was certainly possible for us to complete the Chapter 4 sample development program with one service class that handles everything: input, output, and computation tasks. The chance of reusing such a class, however, is very low. Just as we do not expect to buy a textbook that teaches all five subject matters of single-variable calculus, introduction to economics, organic chemistry, introduction to programming, and western civilization, we do not want a service class that is overloaded with many different types of tasks. We do not want one class that does everything. Rather, we want many classes, with each class doing one task effectively and efficiently. This will allow us to mix and match the classes easily.

Finally, the output values can be formatted by using the technique introduced in Section 6.7. Overall design is now complete. It is left as an exercise (Exercise 17) to implement the loan table calculation program.

6.9 Estimating the Execution Time

We promised at the end of Section 6.1 to compare the two versions of `gcd` methods experimentally. Detailed analysis of algorithms is beyond the scope of this book (we provide a little bit of analytical comparisons of sorting algorithms in this book), but experimental analysis is within our realm. We can compare the performance of different methods by actually running them and clocking their execution times.

Here's the basic idea:

```

Start the clock (stopwatch)

Run the method

Stop the clock

Report the elapsed time

```

There is no clock or stopwatch standard class, but we can time the execution by using the `Date` class from the `java.util` package. Before we call the method we want to time, we record the start time by creating a `Date` object. After the method is completed, we record the end time by creating a second `Date` object. Calling the `getTime` method of the `Date` class returns the number of milliseconds (1 ms = 1/1000 s) since January 1, 1970 00:00:00 Greenwich Mean Time. So by subtracting the start time from the end time, we can get the elapsed time in milliseconds. Here's the general idea:

```

Date startTime = new Date();

//the method call comes here

```

```
Date endTime = new Date();

long elapsedTimeInMilliseconds =
    endTime.getTime() - startTime.getTime();
```

Now let's write a short program to time the performance of `gcd` and `gcd_bruteforce`. The program includes many of the techniques discussed in this chapter. Here's the program (we do not repeat the method bodies of `gcd` and `gcd_bruteforce` here):

```
/*
Chapter 6 Sample Program: Time the performance of gcd methods
File: Ch6TimeGcd.java
*/
import java.util.*;
class Ch6TimeGcd {
    private static enum ComputationType {BRUTE_FORCE, EUCLID}
    private Scanner scanner;
    public static void main(String[] args) {
        Ch6TimeGcd tester = new Ch6TimeGcd( );
        tester.start();
        System.exit(0);
    }
    public Ch6TimeGcd() {
        scanner = new Scanner(System.in);
    }
    public void start( ) {
        long bruteForceTime, euclidTime;
        int m, n;
        while (isContinue()) {
            m = getPositiveInteger( );
            n = getPositiveInteger( );

            //Time the brute force method
            bruteForceTime = timeMethod(m, n, ComputationType.BRUTE_FORCE);

            //Time the Euclidean method
            euclidTime = timeMethod(m, n, ComputationType.EUCLID);
```

```

        System.out.println("M: " + m);
        System.out.println("N: " + n);
        System.out.println("Brute Force Time: " + bruteForceTime);
        System.out.println("Euclidean Time: " + euclidTime + "\n");
    }
}

private long timeMethod(int m, int n, ComputationType type) {
    Date startTime, endTime;
    startTime = new Date();

    if (type == ComputationType.BRUTE_FORCE) {
        gcd_bruteforce(m, n);
    } else {
        gcd(m, n);
    }

    endTime = new Date();

    return (endTime.getTime() - startTime.getTime());
}

private int getPositiveInteger( ) {
    int input;

    while (true) {
        System.out.print("Enter positive integer (0 is okay):");
        input = scanner.nextInt();

        if (input >= 0) break;

        System.out.println("Input must be 0 or more");
    }

    return input;
}

private boolean isContinue( ) {
    String input;

    boolean response = false;

    System.out.print("Run test? ");

    input = scanner.next();

    if (input.equals("Y") || input.equals("y")) {
        response = true;
    }
}

```

```

    return response;
}

private int gcd_bruteforce(int m, int n) {
    . . .
}

private int gcd(int m, int n) {
    . . .
}
}

```

Here's a sample interaction:

```

Run test? y
Enter positive integer (0 is okay):4567820
Enter positive integer (0 is okay):2147483640
M: 4567820
N: 2147483640
Brute Force Time: 94
Euclidean Time: 0

Run test? y
Enter positive integer (0 is okay):1457689098
Enter positive integer (0 is okay):2147483640
M: 1457689098
N: 2147483640
Brute Force Time: 31953
Euclidean Time: 0

Run test? n

```

The value of 0 for Euclidean time does not imply that it took no time to compute the result. It means that the time it took was so miniscule, we weren't able to detect it by the technique we used. Notice that, for the brute-force approach, the difference in the running times between the small and large values for M is substantial, while the difference for the Euclidean approach is not discernible. Detailed analysis will actually tell us that the running time for the brute-force approach is linearly proportional to the input size M , while the Euclidean approach is logarithmically proportional to the input size M . So, for the second comparison in the sample run, there will be 1,457,689,098 divisions performed (actually twice this number because we are executing `m % i == 0` && `n % i == 0`) in `gcd_bruteforce`, but only $\log 1,457,689,098 \cong 9$ divisions. See how superior the Euclidean approach is?

Keep in mind that the value we get for the elapsed time is a rough estimate. For one thing, the values we get for the elapsed time differ dramatically according to which CPU we run the program on and whether other processes are running at the same time (e.g., if a garbage collection routine kicks in while a method is running, then the runtime estimate can be way off). Also, the granularity is very coarse when timed from a high-level language such as Java. For example, it is not possible to distinguish between the program that runs in 5 ms and the program that runs in 6 ms. Although the value is a rough estimate, it still give us useful information such as the rate of increase in execution time as we increase the size of input values.

Things to Remember



To estimate the running time of a loop statement:

1. Record the start time by creating a **Date** object, say, **startTime**, before the loop statement.
2. Record the end time by creating another **Date** object, say, **endTime**, after the loop statement.
3. Elapsed time (in milliseconds) is computed as follows:

```
elapsedTime = endTime.getTime()
              - startTime.getTime();
```

6.10 Recursive Methods (Optional)

recursive
method

In addition to the three repetition control statements we introduced in this chapter, there is a fourth way to control the repetition flow of a program by using recursive methods. A *recursive method* is a method that contains a statement (or statements) that makes a call to itself. We explain recursive methods briefly in this section. Realistic examples of recursive methods will be given in Chapter 15.

So far, we have seen only methods that call other methods, something like this:

```
methodOne(...) {
    ...
    methodTwo(...); //methodOne called methodTwo
    ...
}

methodTwo(...) {
    ...
}
```

A recursive method calls itself, and it looks something like this:

```
methodOne(...) {
    ...
```

```

    methodOne (...); //calls the method itself
    ...
}

```

At first glance, it seems as if a recursive call will never end since the call is made to the same method. Indeed, if you do not follow the rules, you could end up with infinite recursive calls. In this section we explain how to write recursive methods correctly.

Suppose we want to compute the factorial of N . The *factorial* of N is the product of the first N positive integers, denoted mathematically as

$$N! = N * (N-1) * (N-2) * \dots * 2 * 1$$

We will write a recursive method to compute the factorial of N . Mathematically, we can define the factorial of N recursively as

$$\text{factorial}(N) = \begin{cases} 1 & \text{if } N = 1 \\ N * \text{factorial}(N-1) & \text{otherwise} \end{cases}$$

The definition states that if N is 1, then the function $\text{factorial}(N)$ has the value 1. Otherwise, the function $\text{factorial}(N)$ is the product of N and $\text{factorial}(N-1)$. For example, the function $\text{factorial}(4)$ is evaluated as follows:

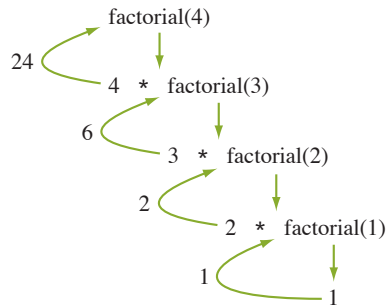

The recursive factorial method parallels the preceding mathematical definition. The method is defined thus:

```

//Assume N is greater than 0
public int factorial(int N) {
    if (N == 1) <-- Test to stop or continue.
        return 1; <-- End case: recursion stops.
    else
        return N * factorial(N-1); <-- Recursive case:
}                                     recursion continues with
                                     another recursive call.

```

The diagram in Figure 6.14 illustrates the sequence of calls for the recursive factorial method. Recursive methods will contain three necessary components.

Things to Remember



The three necessary components in a recursive method are

1. A test to stop or continue the recursion.
2. An end case that terminates the recursion.
3. A recursive call(s) that continues the recursion.

To ensure that the recursion will stop eventually, we must pass arguments different from the incoming parameters. In the factorial method, the incoming parameter was N , while the argument passed in the recursive call was $N-1$. This difference of 1 between the incoming parameter and the argument will eventually make the argument in a recursive call be 1, and the recursion will stop.

Let's implement two more mathematical functions using recursion. The next method computes the sum of the first N positive integers $1, 2, \dots, N$. Notice how this method includes the three necessary components of a recursive method.

```
public int sum ( int N ) { //assume N >= 1
    if ( N == 1 )
        return 1;
    else
        return N + sum( N-1 );
}
```

The last method computes the exponentiation A^N , where A is a real number and N is a positive integer. This time, we have to pass two arguments— A and N . The value of A will not change in the calls, but the value of N is decremented after each recursive call.

```
public double exponent ( double A, int N ) {
    if ( N == 1 )
        return A;
    else
        return A * exponent( A, N-1 );
}
```

So far we used only mathematical functions to illustrate recursive methods, but recursion is not limited to mathematical functions. Let's look at one example. We know the length method of the String class returns the number characters in a given string. Let's write a recursive method that does the same thing. Here's how we think recursively. The total number of characters in a string is 1 plus the number of characters in the substring from the second position to the end of the string. If the

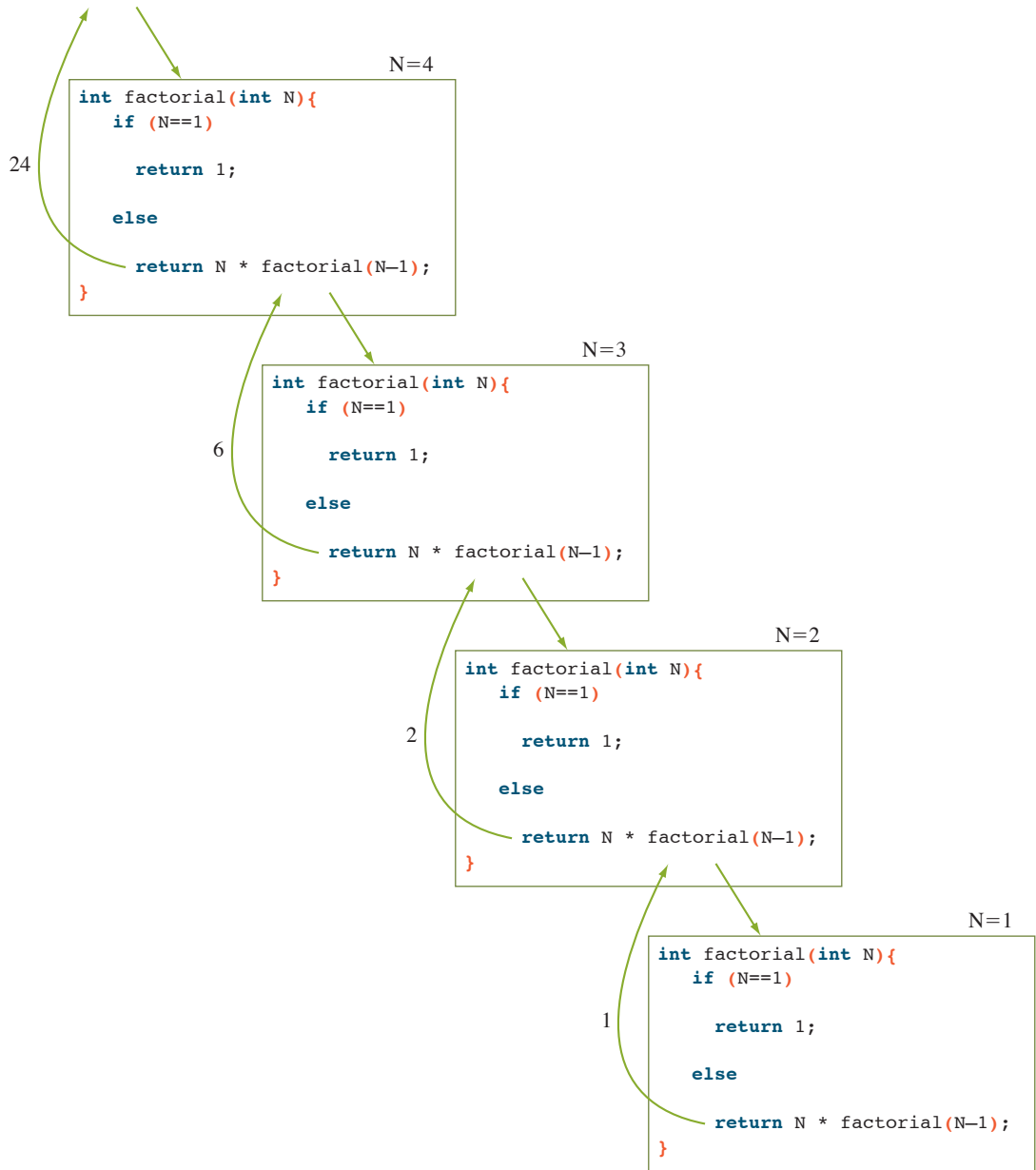

Figure 6.14 The sequence of calls for the recursive **factorial** method.

string has no characters, then the length is zero. Putting this idea into an actual method, we have

```
public int length(String str) {
    if (str.equals("")) { //str has no characters
        return 0;
    } else {
        return 1 + length(str.substring(1));
    }
}
```

Index of the second position is 1.

We will present more examples of recursive methods that implement nonnumerical operations in Chapter 15.

We used factorial, sum, exponentiation, and length as examples to introduce some of the basic concepts of recursion, but we should never actually write these methods using recursion. The methods can be written more efficiently in an iterative (i.e., nonrecursive) manner using a simple for loop. In practice, we use recursion if certain conditions are met.

Things to Remember



Use recursion if

1. A recursive solution is natural and easy to understand.
2. A recursive solution does not result in excessive duplicate computation.
3. The equivalent iterative solution is too complex.

As a final review of the topic, we conclude this section with the recursive version of the Euclidean gcd method. Remember the logic behind the Euclidean gcd method is a sequence of reducing the problem, for example, $\text{gcd}(48, 16) = \text{gcd}(16, 12) = \text{gcd}(12, 4) = 4$. Here's how we can express this thinking recursively:

```
public int gcd_recursive(int m, int n) {
    int result;
    if (m == 0) { //test
        result = n; //end case
    } else {
        result = gcd_recursive(n % m, m); //recursive case
    }
    return result;
}
```

6.11 Sample Development

Hi-Lo Game

In this section we will develop a program that plays a Hi-Lo game. This program illustrates the use of repetition control, the random number generator, and the testing strategy. The objective of the game is to guess a secret number between 1 and 100. The program will respond with **HI** if the guess is higher than the secret number and **LO** if the guess is lower than the secret number. The maximum number of guesses allowed is six. If we allow up to seven, one can always guess the secret number. Do you know why?

Problem Statement

*Write an application that will play Hi-Lo games with the user. The objective of the game is for the user to guess the computer-generated secret number in the least number of tries. The secret number is an integer between 1 and 100, inclusive. When the user makes a guess, the program replies with **HI** or **LO** depending on whether the guess is higher or lower than the secret number. The maximum number of tries allowed for each game is six. The user can play as many games as she wants.*

Overall Plan

We will begin with our overall plan for the development. Let's identify the major tasks of the program. The first task is to generate a secret number every time the game is played, and the second task is to play the game itself. We also need to add a loop to repeat these two tasks every time the user wants to play the Hi-Lo game. We can express this program logic in pseudocode as follows:

program
tasks

```
do {
    Task 1: generate a secret number;
    Task 2: play one game;
} while ( the user wants to play );
```

Let's look at the two tasks and determine objects that will be responsible for handling the tasks. For the first task, we will use the **random** method of the **Math** class. We will examine this method in detail later to determine whether it is the one we can use in the program. If this method does not meet our needs, then we will explore further and most likely will have to derive our own random number generator.

For the second task of playing the game itself, we use objects that handle I/O and the logic of repeatedly asking for the next guess until the game is over. For input and output, we use a **Scanner** and **System.out**. We will define a class to handle the logic of playing the game. This class will control the other two classes. We will name this class **Ch6HiLo**, and it will be an instantiable main class.

6.11 Sample Development—continued

Here's our working design document:

program
classes

Design Document: Ch6HiLo	
<p>Class</p> <p>Ch6HiLo</p> <p>Scanner</p> <p>PrintStream (System.out)</p>	<p>Purpose</p> <p>The top-level control object handles the logic of playing games and manages other objects. This is the instantiable main class.</p> <p>This standard class is for inputting user guesses.</p> <p>This standard class is for displaying hints and other messages.</p>

Figure 6.15 is the program diagram for this program. A keen observer may have noticed that the **Ch6HiLo** class is handling both types of tasks: handling of user interface and controlling the logic of game playing. We will revisit this design in the GUI chapter and provide an alternative. The one-class design we adopt here may not be an ideal design, but may be acceptable for a simplistic game such as this one. The design also provides us with a meaningful comparison when we present an alternative design in the GUI chapter.

We will implement this program using the following four major steps:

develop-
ment steps

1. Start with a skeleton **Ch6HiLo** class.
2. Add code to the **Ch6HiLo** class to play a game using a dummy secret number.
3. Add code to the **Ch6HiLo** class to generate a random number.
4. Finalize the code by removing temporary statements and tying up loose ends.

Step 1 Development: Program Skeleton

step 1
design

The structure of the **HiLoMain** class is the same as other main classes. All we need to do is to declare, create, and start a **HiLo** object. Instead of forcing the user to play at least one

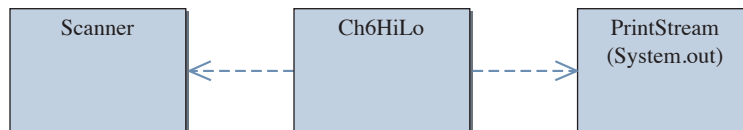

Figure 6.15 The program diagram for the **HiLo** program.

game, we will implement the program so the user has an option of not playing a game at all. In pseudocode we can express this logic as follows:

```

describe the game rules;
prompt the user to play a game or not;
while ( answer is yes ) {
    generate the secret number;
    play one game;
    prompt the user to play another game or not;
}

```

Notice that we use a **while** loop here, so the user can quit the program without playing a game. If we use a **do-while** loop instead, then the user must play at least one game before stopping the program. We opt to use the **while** loop because the user may not want to play the game at all after reading the game rules.

We use a private method **describeRules** to display the game rules. Another private method named **prompt** gets a yes/no reply from the user. We call this method to ask if the user wants to play a game. To generate a secret number, we have the third private method **generateSecretNumber**. Lastly, we define the fourth private method **playGame** to play one game. We declare these four methods **private** because these methods are for internal use. As always, we will use the constructor to perform necessary object creation and initialization.

Our working design document for the **HiLo** class is as follows:

Design Document: The Ch6HiLo Class		
Method	Visibility	Purpose
<constructor>	public	Creates and initializes the objects used by a HiLo object.
start	public	Starts the Hi-Lo game playing. The user has an option of playing a game or not.
describeRules	private	Displays the game rules in System.out.
generateSecretNumber	private	Generates a secret number for the next Hi-Lo game.
playGame	private	Plays one Hi-Lo game.
prompt	private	Prompts the user for a yes/no reply.

6.11 Sample Development—continued

step 1 code

For the skeleton program, we include temporary output statements in the private methods to verify that they are called correctly in the right order. Here's the skeleton **Ch6HiLo** class:

```
import java.util.*;

/*
Chapter 6 Sample Development: Hi-Lo Game (Step 1)
The instantiable main class of the program.
*/

class Ch6HiLo {
    private static enum Response {YES, NO}
    private Scanner scanner;

    //Main Method
    public static void main (String[] args) {
        Ch6HiLo hiLo = new Ch6HiLo( );
        hiLo.start();
    }

    public Ch6HiLo( ) {
        scanner = new Scanner(System.in);
    }

    public void start( ) {
        Response answer;

        describeRules();

        answer = prompt("Do you want to play a Hi-Lo game?");
        while (answer == Response.YES) {
            generateSecretNumber( );
            playGame();
            answer = prompt("Do you want to play another Hi-Lo game?");
        }
        System.out.println("Thank you for playing Hi-Lo.");
    }
}
```

main

Constructor

start

```

private void describeRules( ) {
    System.out.println("Inside describeRules"); //TEMP
}

private void generateSecretNumber( ) {
    System.out.println("Inside generateSecretNumber"); //TEMP
}

private void playGame( ) {
    System.out.println("Inside playGame"); //TEMP
}

private Response prompt(String question) {
    String input;

    Response response = Response.NO;

    System.out.print(question + " (Yes - y; No - n): ");

    input = scanner.next();

    if (input.equals("Y") || input.equals("y")) {
        response = Response.YES;
    }

    return response;
}

```

describeRules

generateSecretNumber

playGame

prompt

step 1 test

We execute the skeleton **Ch6HiLo** class to verify that the class is coded correctly. To verify the correct execution of step 1, we attempt to play the game

1. Zero times
2. One time
3. One or more times

For the first run, we select **No** to the prompt **Do you want to play a Hi-Lo game?** and make sure the program stops without playing a game. For the second run, we select **Yes** to the first prompt and verify that the messages **Inside generateSecretNumber** and **Inside playGame** are shown in the console window. We select **No** to the prompt **Do you want to play another Hi-Lo game?** and make sure the program stops. For the third run, we make sure we can play more than one game. After we verify all the scenarios work correctly, we proceed to the next step.

6.11 Sample Development—continued

step 2
design**Step 2 Development: Play a Game with a Dummy Secret Number**

In the second development step, we add a routine that plays a Hi-Lo game. Let's begin with the control flow of the **playGame** method. There are two cases to end a Hi-Lo game: The user either guesses the number in less than six tries or uses up all six tries without guessing the number. So we need a counter to keep track of the number of guesses made. Let's call this counter **guessCount**. We stop the game when **guessCount** becomes larger than 6 or the user's guess is equal to the secret number. At the end of the game, we output an appropriate message. Expressing this in pseudocode, we have

```
//Method: playGame
set guessCount to 0;
do {
  get next guess;

  increment guessCount;

  if (guess < secretNumber) {
    print the hint LO;
  } else if (guess > secretNumber) {
    print the hint HI;
  }
} while (guessCount < number of guesses allowed &&
        guess != secretNumber );

if (guess == secretNumber) {
  print the winning message;
} else {
  print the losing message;
}
```

All variables used in this method will be local except **secretNumber**, which will be an instance variable. The value for **secretNumber** is set inside the **generateSecretNumber** method.

To support a better user interface, we will include an input error handling that allows the user to enter only values between **1** and **100**. We will do this input-error-checking routine in a new private method **getNextGuess** because we do want to keep the **playGame** method clean and simple. If we included the code for input error handling directly inside

the **playGame** method, the method would become too cluttered and lose the overall clarity of what the method is doing. Pseudocode for the **getNextGuess** method is

```
//Method: getNextGuess
while ( true ) {
    get input value;
    if (valid input) return input value;
    print error message;
}
```

The working design document of the class now includes this new private method:

Design Document: The Ch6HiLo Class		
Method	Visibility	Purpose
...
getNextGuess	private	Returns the next guess from the user. Only accepts a guess between 1 and 100. Prints an appropriate error message when an invalid guess is entered.

step 2 code

In the step 2 coding, we need to implement three methods. In addition to the **playGame** and **getNextGuess** methods, we need to define a temporary **generateSecretNumber** method so we can test the **playGame** method. The temporary **generateSecretNumber** method assigns a dummy secret number to the instance variable **secretNumber**. The temporary method is coded as follows:

```
private void generateSecretNumber( ) {
    secretNumber = 45;    //TEMP
}
```

Any number will do; we simply picked the number **45**. Knowing that the secret number is **45**, we will be able to test whether the **playGame** method is implemented correctly.

We implement the **playGame** method thus:

```
private void playGame( ) {
    int guessCount = 0;
    int guess;

    do {
        //get the next guess
        guess = getNextGuess();
        guessCount++;
    }
```

getNextGuess is a new private method.

6.11 Sample Development—continued

Repeat the loop if the number of tries is not used up and the correct guess is not made.

```

//check the guess
if (guess < secretNumber) {
    System.out.println
        "Your guess is LO");
} else if (guess > secretNumber) {
    System.out.println
        "Your guess is HI");
}
} while ( guessCount < MAX_GUESS_ALLOWED &&
    guess != secretNumber );
//output appropriate message
if ( guess == secretNumber ) {
    System.out.println
        "You guessed it in "
        + guessCount + " tries.");
} else {
    System.out.println
        "You lost. Secret No. was "
        + secretNumber);
}
}

```

This class constant is set to 6.

The `getNextGuess` method will accept an integer between **1** and **100**. The method uses a `while` loop to accomplish this:

```

private int getNextGuess( ) {
    int input;
    while (true) {
        System.out.print("Next Guess: ");
        input = scanner.nextInt();
        if (LOWER_BOUND <= input && input <= UPPER_BOUND) {
            return input;
        }
        //invalid input; print error message
        System.out.println("Invalid Input: " +
            "Must be between " + LOWER_BOUND +
            "and " + UPPER_BOUND);
    }
}

```

The necessary constant and instance variable are declared in the data member section of the **HiLo** class as follows:

```
//-----
// Data Members
//-----
private final int MAX_GUESS_ALLOWED = 6;
private final int LOWER_BOUND      = 1;
private final int UPPER_BOUND      = 100;

private int secretNumber;
```

step 2 test

We need to test two methods in this step. To verify the **getNextGuess** method, we input both invalid and valid guesses. We verify the method by running the following tests:

1. Enter a number less than 1.
2. Enter a number greater than 100.
3. Enter a number between 2 and 99.
4. Enter 1.
5. Enter 100.

test cases

The first two **test cases** are called *error cases*, the third is called the *normal case*, and the last two are called *end cases*. One of the common errors beginners make is to create a loop statement that does not process the end cases correctly. When our code handles all three types of cases correctly, we will proceed to test the **playGame** method.

To verify the **playGame** method, we need to perform a more elaborate testing. Knowing that the dummy secret number is **45**, we verify the **playGame** method by running the following tests:

1. Enter a number less than **45** and check that the correct hint **LO** is displayed.
2. Enter a number greater than **45** and check that the correct hint **HI** is displayed.
3. Enter the correct guess, and check that the game terminates after displaying the appropriate message.
4. Enter six wrong guesses, and check that the game terminates after displaying the appropriate message.

When all four tests are successfully completed, we proceed to the next step.

Step 3 Development: Generate a Random Number

step 3 design

In step 3, we add a routine that generates a random number between **1** and **100**. As explained in Chapter 3, we can use the **Random** class.

6.11 Sample Development—continued

step 3 code

The `generateSecretNumber` method is defined thus:

```
private void generateSecretNumber( ) {
    secretNumber = random.nextInt(100) + 1;
    System.out.println("Secret Number: " + secretNumber);
                                // TEMP
}
```

We include a temporary output statement to verify that the secret number is valid. Knowing the secret number is also useful because we can stop the game anytime we want by entering the correct guess. The `Random` object `random` is a private data member and initialized in the constructor:

```
private Random random;
...
public Ch6HiLo( ) {
    ...
    random = new Random( );
}
```

step 3 test

To verify that the method generates correct random numbers, we will write a separate test program. If we don't use such a test program and instead include the method immediately in the `Ch6HiLo` class, we have to play the game, say, 100 times to verify that the first 100 generated numbers are valid. The test program generates `N` random numbers and stops whenever an invalid number is generated. We will set `N` to `1000`. Here's the test program:

TestRandom
class
for testing

```
import java.util.*;
class TestRandom {

    public static void main (String args[]) {
        int N = 1000, count = 0, number;
        Random random = new Random();

        do {
            count++;
            number = random.nextInt(100) + 1;
        } while (count < N &&
                1 <= number && number <= 100);
    }
}
```

```

        if (number < 1 || number > 100) {
            System.out.println("Error: " + number);
        } else {
            System.out.println("Okay");
        }
    }
}

```

Keep in mind that successfully generating 1000 valid random numbers does not guarantee that the 1001st number is also valid. We did not offer any formal mathematical proof that the routine for the random number generator works correctly. What we are doing here is making an assumption that no user wants to play more than 1000 Hi-Lo games in one session, which we believe is a practical and reasonable assumption. After the **TestRandom** class is executed correctly, we make the necessary changes to the **Ch6HiLo** class and run it. When we verify that the program runs as expected, we proceed to the final step.

Step 4 Development: Finalize

program
review

We finalize the program in the last step. We will perform a critical review of the program, looking for any unfinished method, inconsistency, or error in the methods; unclear or missing comments; and so forth. We should also not forget to keep an eye on any improvement we can make to the existing code.

We still have a temporary code inside the **describeRules** method, so we will complete the method by adding code to describe the game rules. This method is left as Exercise 18.

There are still temporary output statements that we used for verification purposes. We can either delete them from the program or comment them out. We will leave them in the program by commenting them out so when the time comes for us to modify, debug, or update the program, we do not have to reenter them.

Summary

- A repetition control statement is used to repeatedly execute a block of code until a certain condition is met.
- Three repetition control statements are while, do-while, and for.
- The count-controlled loop executes the loop body for a fixed number of times.
- The sentinel-controlled loop executes the loop body until any one of the designated values called a *sentinel* is encountered.
- Count-controlled loops can be implemented most naturally with the for statements.

- Sentinel-controlled loops can be implemented most naturally with the while or do-while statements.
- The while statement is called a *pretest loop*, and the do-while statement is called a *posttest loop*. The for statement is also a pretest loop.
- Reading a value before the loop statement is called a *priming read*.
- Off-by-1 error and infinite loop are two common mistakes in writing a loop control.
- The loop-and-a-half repetition control is the most general way of writing a loop. The break statement is used within the loop body to exit the loop when a certain condition is met.
- The nested for statement is used very often because it is ideally suited to process tabular data.
- Output values can be formatted by using the Formatter class.
- Execution time can be estimated by using the Date class.

Key Concepts

repetition statements	pseudocode
while statements	loop-and-a-half control
do-while statements	one-entry-one-exit control
for statements	count-controlled loops
off-by-1 error	sentinel-controlled loops
infinite loop	pretest and posttest loops
priming read	formatting output values
nested for statements	recursive methods (optional)

Chapter 6 Exercises

Review Exercises

1. Identify all the errors in the following repetition statements. Some errors are syntactical while others are logical (e.g., infinite loops).

```
a. for (int i = 10; i > 0; i++) {
    x = y;
    a = b;
}

b. int sum = 0;
Scanner scanner = new Scanner(System.in);
do {
    num = scanner.nextInt();
    sum += num;
} until (sum > 10000);
```

```

c. while (x < 1 && x > 10) {
    a = b;
}

d. while (a == b) ;
{
    a = b;
    x = y;
}

e. for (int i = 1.0; i <= 2.0; i += 0.1) {
    x = y;
    a = b;
}

```

2. Write for, do-while, and while statements to compute the following sums and products.

- $1 + 2 + 3 + \cdots + 100$
- $5 + 10 + 15 + \cdots + 50$
- $1 + 3 + 7 + 15 + 31 + \cdots + (2^{20} - 1)$
- $1 + \frac{1}{2} + \frac{1}{3} + \frac{1}{4} + \cdots + \frac{1}{15}$
- $1 \times 2 \times 3 \times \cdots \times 20$
- $1 \times 2 \times 4 \times 8 \times \cdots \times 2^{20}$

3. What will be the value of sum after each of the following nested loops is executed?

```

a. sum = 0;
   for (int i = 0; i <= 10; i++)
       for (int j = 0; j <= 10; j++)
           sum += i ;

b. sum = 0;
   j = 0;
   do {
       j++;
       for (int i = 5; i > j; i--)
           sum = sum + (i+j);
   } while (j < 11);

c. sum = 0;
   i = 0;
   while (i < 5) {
       j = 5;
       while (i != j) {
           sum += j;

```



```

        j--;
    }
    i++;
}

d. sum = 0;
   for (int i = 0; i <= 10; i++)
       for (int j = 10; j > 2*i; j--)
           sum = sum + (j - i);

```

4. Determine the output from the following code without actually executing it.

```

System.out.format("%4d", 234);
System.out.format("%5d", 234);

System.out.format("%s", "\n");

System.out.format("$%6.2f", 23.456);
System.out.format("%s", "\n");

System.out.format("%1$3d+%1$3d=%2$5d", 5, (5+5));

```

5. Rewrite the following nested for statements, using nested do-while and while statements.

```

a. sum = 0;
   number = 0;
   for (int i = 0; i <= 10; i++)
       for (int j = 10; j >= i; j--) {
           number++;
           sum = sum + (j - i);
       }

b. product = 1;
   number = 0;
   for (int i = 1; i < 5; i++)
       for (int j = 1; j < 5; j++) {
           number++;
           product *= number;
       }

```

Level 1 Programming Exercises ★

6. Write a program to print out the numbers 10 through 49 in the following manner:

```

10 11 12 13 14 15 16 17 18 19
20 21 22 23 24 25 26 27 28 29
30 31 32 33 34 35 36 37 38 39
40 41 42 43 44 45 46 47 48 49

```

How would you do it? Here is an example of poorly written code:

```

for (int i = 10; i < 50; i++) {
    switch (i) {
        case 19:
        case 29:
        case 39: System.out.println(" " + i); //move to the
            break; //next line
        default: System.out.print(" " + i);
    }
}

```

This code is not good because it works only for printing 10 through 49. Try to develop the code so that it can be extended easily to handle any range of values. You can do this coding in two ways: with a nested for statement or with modulo arithmetic. (If you divide a number by 10 and the remainder is 9, then the number is 9, 19, 29, or 39, and so forth.)

7. A *prime number* is an integer greater than 1 and divisible by only itself and 1. The first seven prime numbers are 2, 3, 5, 7, 11, 13, and 17. Write a method that returns true if its parameter is a prime number. Using this method, write a program that repeatedly asks the user for input and displays Prime if the input is a prime number and Not Prime, otherwise. Stop the repetition when the input is a negative number.
8. Complete the loan table program discussed in Section 6.8.
9. Implement the describeRules method of the Ch6HiLo class from Section 6.9. At the beginning of the program, ask the user whether or not to display the game rules.
10. The price table for carpet we printed out in Section 6.6 contains index values for width and length, but not labels to identify them. Write a program that generates the table shown next:

	LENGTH				
	5	10	15	20	25
11	1045	2090	3135	4180	5225
12	1140	2280	3420	4560	5700
13	1235	2470	3705	4940	6175
14	1330	2660	3990	5320	6650
15	1425	2850	4275	5700	7125
16	1520	3040	4560	6080	7600
17	1615	3230	4845	6460	8075
18	1710	3420	5130	6840	8550
19	1805	3610	5415	7220	9025
20	1900	3800	5700	7600	9500

11. Extend the HiLo class to allow the user to designate the lower and upper bounds of the secret number. In the original HiLo class, the bounds are set to 1 and 100, respectively.
12. Improve the LoanCalculator class from Chapter 4 to accept only the valid input values for loan amount, interest rate, and loan period. The original LoanCalculator class assumed the input values were valid. For the exercise, let the loan amount between \$100.00 and \$1,000,000.00, the interest rate between 5 and 20 percent, and the loan period between 1 year and 30 years be valid.

Level 2 Programming Exercises ★★

13. There are 25 primes between 2 and 100, and there are 1229 primes between 2 and 10,000. Write a program that inputs a positive integer $N > 2$ and displays the number of primes between 2 and N (inclusive). Use the timing technique explained in Section 6.9 to show the amount of time it took to compute the result.
14. Instead of actually computing the number of primes between 2 and N , we can get an estimate by using the Prime Number Theorem, which states that

$$\text{prime}(N) \approx \left\lfloor \frac{N}{\ln(N)} \right\rfloor$$

where $\text{prime}(N)$ is the number of primes between 2 and N (inclusive). The function \ln is the natural logarithm. Extend the program for Exercise 13 by printing the estimate along with the actual number. You should notice the pattern that the estimate approaches the actual number as the value of N gets larger.

15. A *perfect number* is a positive integer that is equal to the sum of its proper divisors. A proper divisor is a positive integer other than the number itself that divides the number evenly (i.e., no remainder). For example, 6 is a perfect number because the sum of its proper divisors 1, 2, and 3 is equal to 6. Eight is not a perfect number because $1 + 2 + 4 \neq 8$. Write a program that accepts a positive integer and determines whether the number is perfect. Also, display all proper divisors of the number. Try a number between 20 and 30 and another number between 490 and 500.
16. Write a program that lists all perfect numbers between 6 and N , an upper limit entered by the user. After you verify the program with a small number for N , gradually increase the value for N and see how long the program takes to generate the perfect numbers. Since there are only a few perfect numbers, you might want to display the numbers that are not perfect so you can easily tell that the program is still running.

17. Write a program that displays all integers between low and high that are the sum of the cube of their digits. In other words, find all numbers xyz such that $xyz = x^3 + y^3 + z^3$, for example, $153 = 1^3 + 5^3 + 3^3$. Try 100 for low and 1000 for high.
18. Write a method that returns the number of digits in an integer argument; for example, 23,498 has five digits. Using this method, write a program that repeatedly asks for input and displays the number of digits the input integer has. Stop the repetition when the input value is negative.
19. Your freelance work with MyJava Lo-Fat Burgers was a success (see Exercise 24 of Chap. 5). The management loved your new drive-through ordering system because the customer had to order an item from each of the three menu categories. As part of a public relations campaign, however, management decided to allow a customer to skip a menu category. Modify the program to handle this option. Before you list items from each category, use a confirmation dialog to ask the customer whether he or she wants to order an item from that category.
20. Extend the program in Exercise 15 so that customers can order more than one item from each menu category. For example, the customer can buy two orders of Tofu Burgers and three orders of Buffalo Wings from the Entree menu category.
21. A formula to compute the N th Fibonacci number was given in Exercise 10 in Chapter 3. The formula is useful in finding a number in the sequence, but a more efficient way to output a series of numbers in the sequence is to use the recurrence relation $F_N = F_{N-1} + F_{N-2}$, with the first two numbers in the sequence F_1 and F_2 both defined as 1. Using this recurrence relation, we can compute the first 10 Fibonacci numbers as follows:

$$\begin{aligned}
 F_1 &= 1 \\
 F_2 &= 1 \\
 F_3 &= F_2 + F_1 = 1 + 1 = 2 \\
 F_4 &= F_3 + F_2 = 2 + 1 = 3 \\
 F_5 &= F_4 + F_3 = 3 + 2 = 5 \\
 F_6 &= F_5 + F_4 = 5 + 3 = 8 \\
 F_7 &= F_6 + F_5 = 8 + 5 = 13 \\
 F_8 &= F_7 + F_6 = 13 + 8 = 21 \\
 F_9 &= F_8 + F_7 = 21 + 13 = 34 \\
 F_{10} &= F_9 + F_8 = 34 + 21 = 55
 \end{aligned}$$

Write a program that accepts N , $N \geq 1$, from the user and displays the first N numbers in the Fibonacci sequence. Use appropriate formatting to display the output cleanly.

22. Modify the program of Exercise 21 to generate and display all the numbers in the sequence until a number becomes larger than the value `maxNumber` entered by the user.

23. In the formatting examples from the chapter, we always provided a fixed control string, such as

```
System.out.format("%4d", 23);
```

It is possible, however, to dynamically create the control string, as in

```
int i = 4;
System.out.format("%" + i + "d", 23);
```

Using this idea of dynamically creating a control string, write a code fragment that outputs 50 X's, using a separate line for each X. An X on a single line is preceded by two more leading spaces than the X on the previous line. The following figure shows the output for the first five lines.

```
x
  x
    x
      x
        x
```

24. Write a program that inputs N , where $3 \leq N \leq 25$, and outputs a cross. The following figure shows the output when N is 5.

```
x           x
  x       x
    x
  x       x
x           x
```

Use the technique explained in Exercise 22.

25. (Optional) Write a recursive method to compute the sum of the first N positive integers. *Note:* This is strictly for exercise. You should not write the real method recursively.
26. (Optional) Write a recursive method to compute the sum of the first N positive odd integers. *Note:* This is strictly for exercise. You should not write the real method recursively.

Level 3 Programming Exercises ★★★

27. You can compute $\sin x$ and $\cos x$ by using the following power series:

$$\sin x = x - \frac{x^3}{3!} + \frac{x^5}{5!} - \frac{x^7}{7!} + \dots$$

$$\cos x = 1 - \frac{x^2}{2!} + \frac{x^4}{4!} - \frac{x^6}{6!} + \dots$$

Write a program that evaluates $\sin x$ and $\cos x$ by using the power series. Use the `double` data type, and increase the number of terms in the series until the overflow occurs. You can check if the overflow occurs by comparing the value against `Double.POSITIVE_INFINITY`. Compare the results you obtain to the values returned by the `sin` and `cos` methods of the `Math` class.

28. Extend Exercise 22 on page 300 by drawing a more realistic clock. Instead of drawing a clock like this

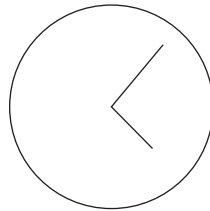

draw a circle at 5-min intervals as follows:

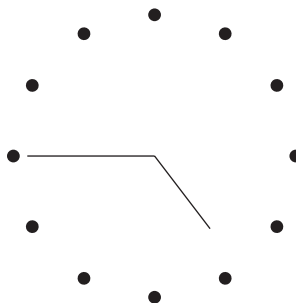

Use a `for` loop to draw 12 circles.

29. Write an application that draws nested N squares, where N is an input to the program. The smallest square is 10 pixels wide, and the width of each

successive square increases by 10 pixels. The following pattern shows seven squares whose sides are 10, 20, 30, . . . , and 70 pixels wide.

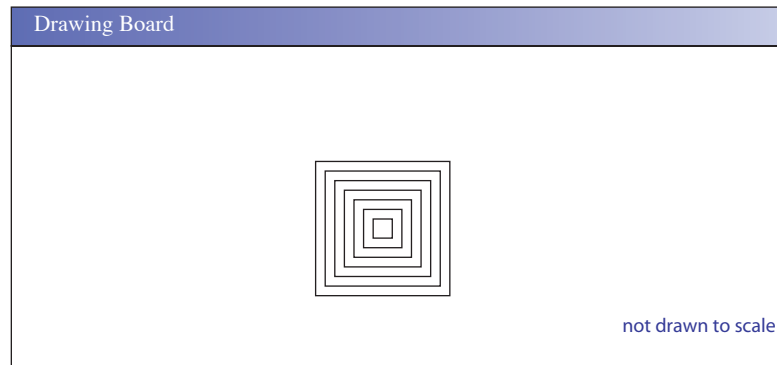

Development Exercises

For the following exercises, use the incremental development methodology to implement the program. For each exercise, identify the program tasks, create a design document with class descriptions, and draw the program diagram. Map out the development steps at the start. Present any design alternatives and justify your selection. Be sure to perform adequate testing at the end of each development step.

30. The monthly payments for a given loan are divided into amounts that apply to the principal and to the interest. For example, if you make a monthly payment of \$500, only a portion of the \$500 goes to the principal and the remainder is the interest payment. The monthly interest is computed by multiplying the monthly interest rate by the unpaid balance. The monthly payment minus the monthly interest is the amount applied to the principal. The following table is the sample loan payment schedule for a 1-year loan of \$5000 with a 12 percent annual interest rate.

Payment No.	Interest	Principal	Unpaid Balance	Total Interest to Date
1	50.00	394.24	4605.76	50.00
2	46.06	398.19	4207.57	96.06
3	42.08	402.17	3805.40	138.13
4	38.05	406.19	3399.21	176.19
5	33.99	410.25	2988.96	210.18
6	29.89	414.35	2574.61	240.07
7	25.75	418.50	2156.11	265.82
8	21.56	422.68	1733.42	287.38
9	17.33	426.91	1306.51	304.71
10	13.07	431.18	875.34	317.78
11	8.75	435.49	439.85	326.53
12	4.40	439.85	0.00	330.93

Write a program that accepts a loan amount, annual interest rate, and loan period (in number of years) and displays a table with five columns: payment number, the interest and principal paid for that month, the remaining balance after the payment, and the total interest paid to date. *Note:* The last payment is generally different from the monthly payment, and your program should print out the correct amount for the last payment. Use the `Format` class to align the output values neatly.

31. Instead of dropping a watermelon from a building, let's shoot it from a cannon and compute its projectile. The (x, y) coordinates of a watermelon at time t are

$$x = V \cos(\alpha) \cdot t$$

$$y = V \sin(\alpha) \cdot t - \frac{g \cdot t^2}{2}$$

where g is the acceleration of gravity, V is the initial velocity, and α (alpha) is the initial angle. The acceleration of gravity on earth is 9.8 m/s^2 .

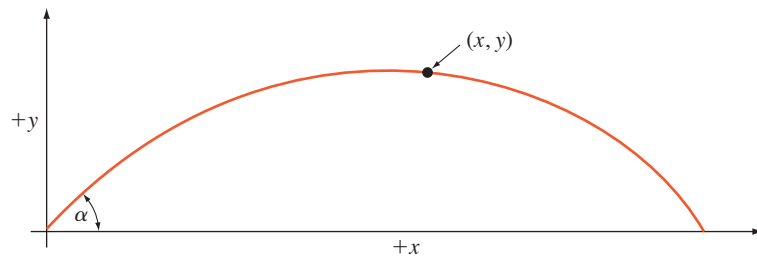

Write a program that inputs an initial velocity V (m/s) and an initial angle α (degrees) and computes the projectile of a watermelon cannon ball. The program should repeat the computation until the user wants to quit. The program outputs the (x, y) ordinate value for every second, that is, $t = 0, 1, 2,$ and so forth. The program stops the output when the y value becomes 0 or less. To use the `cos` and `sin` methods of the `Math` class, don't forget that you have to convert the input angle given in degrees to radians. You can convert a degree to equivalent radians by using the following

$$\text{Radian} = \frac{\text{degree} \times \pi}{180}$$

or calling the `toRadians` method of the `Math` class. *Note:* Air resistance is not considered in the formula. Also, we assumed the watermelon will not get smashed upon firing.

32. Write a program that simulates a slot machine. The player starts out with M coins. The value for M is an input to the program, and you charge 25 cents per coin. For each play, the player can bet 1 to 4 coins. If the player enters 0 as the number of coins to bet, then the program stops playing. At the end of the game, the program displays the number of coins left and how much the

player won or lost in the dollar amount. There are three slots on the machine, and each slot will display one of the three possible pieces: BELL, GRAPE, and CHERRY. When certain combinations appear on the slots, the machine will pay the player. The payoff combinations are as follows:

No.	Combination			Payoff Factor
1	BELL	BELL	BELL	10
2	GRAPE	GRAPE	GRAPE	7
3	CHERRY	CHERRY	CHERRY	5
4	BELL	BELL	-----	3
5	BELL	-----	BELL	3
6	-----	BELL	BELL	3
7	GRAPE	GRAPE	-----	1
8	GRAPE	-----	GRAPE	1
9	-----	GRAPE	GRAPE	1

The symbol ----- means any piece. If the player bets 4 coins and get combination 5, for example, the machine pays the player 12 coins.

Defining Your Own Classes—Part 2

7

O b j e c t i v e s

After you have read and studied this chapter, you should be able to

- Define overloaded methods and constructors.
- Describe the uses of the reserved word **this**.
- Define class methods and variables.
- Describe how the arguments are passed to the parameters in method definitions with the pass-by-value scheme.
- Describe how objects are returned from methods.
- Document classes with javadoc comments.
- Organize classes into a package.

Introduction



In Chapter 4, we covered the basics of programmer-defined classes with illustrative examples. There we focused our attention on straightforward cases. After seeing more sample programs in Chapters 5 and 6, we are now ready to attack advanced topics of programmer-defined classes. In addition to introducing several new topics, we will revisit some of the topics from Chapter 4 and provide a more in-depth discussion. In Chapters 5 and 6, we used the `Fraction` class to illustrate some of the concepts. We will continue to use the `Fraction` class in this chapter to illustrate the key concepts introduced here. Toward the end of this chapter, we will provide a complete definition of the `Fraction` class. In addition to this `Fraction` class, we will go over other sample classes to help students master the key concepts.

7.1 Returning an Object from a Method

return objects
from methods

Up until now, when we define a value-returning method, we return either primitive data types, such as `int` or `boolean`, or a `String`. In this section, we learn how to *return objects from methods*. Again, a `String` is an object, so in a sense, we know how to return an object from a method. However, a `String` is treated much as a primitive datum for the most part. Here, we provide a more complete picture of what is going on when we return an object of other standard and programmer-defined classes.

We use the `Fraction` class to illustrate the returning of an object from a method. Here's the portion of the class definition that includes the constructor, accessors, and mutators (we will add other methods gradually as we cover more topics):

```
class Fraction {
    private int numerator;
    private int denominator;
    public Fraction(int num, int denom) {
        setNumerator(num);
        setDenominator(denom);
    }
    public int getDenominator() {
        return denominator;
    }
    public int getNumerator() {
        return numerator;
    }
}
```

We assume both parameters are nonnegative. We remove this assumption when listing the final version in Section 7.8.

```

public void setDenominator(int denom) {
    if (denom == 0) {
        //Fatal error
        System.err.println("Fatal Error");
        System.exit(1);
    }
    denominator = denom;
}

public void setNumerator(int num) {
    numerator = num;
}

public String toString() {
    return getNumerator() + "/" + getDenominator();
}

//other methods come here
}

```

Notice that we do not allow a fraction to have 0 as its denominator. If there is an attempt to assign 0 as a fraction's denominator, we will terminate the whole program. This is quite a draconian measure, but we will do it this way until we learn exception handling in Chapter 8.

Now, let's study the simplify method that reduces a fraction to its simplest form. How about the following?

```

public void simplify() {
    int num = getNumerator();
    int denom = getDenominator();
    int gcd = gcd(num, denom);

    setNumerator(num/gcd);
    setDenominator(denom/gcd);
}

```

We use the gcd method that returns the greatest common divisor (int) as described in Chapter 6. We get the simplified form by dividing the numerator and the denominator by their greatest common divisor. Here's a sample use of the method:

```

Fraction f1 = new Fraction(24, 36);
f1.simplify(); //f1 is changed!

```

Notice that the value of f1 is now changed because the method updates the data members of the receiving object (in this example, f1 is a receiving object because we are calling the add method of f1).

Is it acceptable to change the values of the receiving object f1? In this case, no. Instead, it is better to keep the values of f1 unchanged and to return a new Fraction object that is in the simplified form. This will give flexibility to client programmers.

Here's the improved version of the simplify method. (We will make an additional improvement in Section 7.8 to properly handle the case when gcd is zero.)

```
public Fraction simplify( ) {
    int num    = getNumerator();
    int denom  = getDenominator();
    int gcd    = gcd(num, denom);

    Fraction simp = new Fraction(num/gcd, denom/gcd);

    return simp;
}
```

The following is the sample use of the improved version:

```
Fraction f1, f2;

f1 = new Fraction(24, 36);

f2 = f1.simplify( );

System.out.println(f1.toString() + "can be reduced to " +
                  f2.toString());
```

The output will be

```
24/36 can be reduced to 2/3
```

Be aware that we can produce such output easily because we did not change the values of `f1`. Now, if we really want to reduce `f1` itself to simplest form, then we just have to assign the result back to `f1` as in

```
f1 = f1.simplify( );
```

Let's study the effect of the `simplify` method when it returns an object. Figure 7.1 shows the state of memory after the `simp` object is created and assigned the values. Notice that `simp` is a local variable, but the object itself is created in the heap memory. The return statement at the end of the `simplify` method returns the value of `simp`, which is a reference to the `Fraction` object. Figure 7.2 shows the state after the `simplify` method is complete. The value of `simp` is assigned to `f2`, and now the variable `f2` points to this `Fraction` object. It is critical to realize that when we say *return an object from a method*, we are in fact returning a reference to the object.

Things to Remember



When we say "return an object from a method," we are actually returning the address, or reference, of an object to the caller.

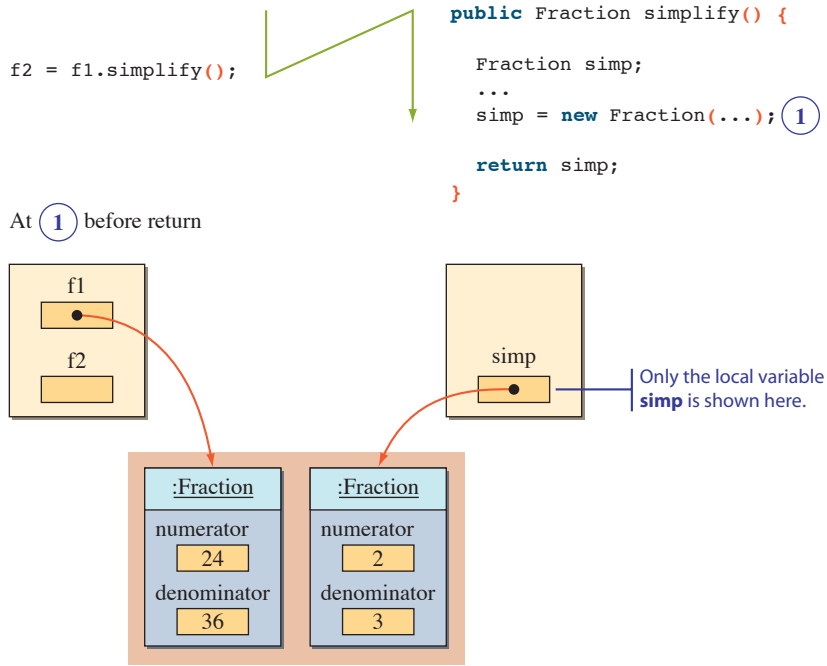

Figure 7.1 This illustration shows the state after the `simp` object is created and assigned with the correct values.

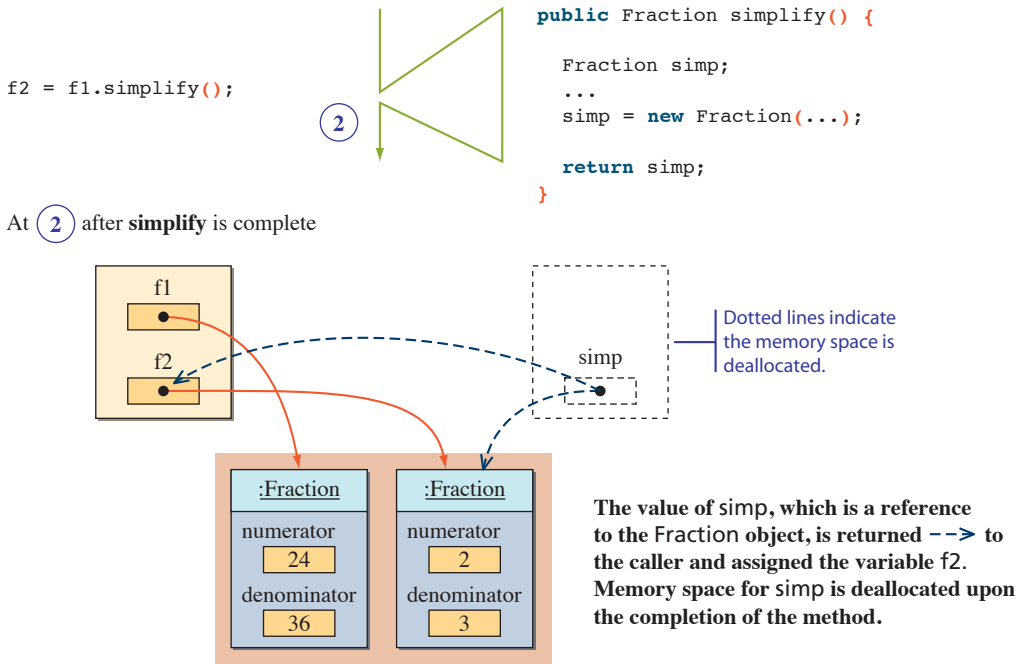

Figure 7.2 Continuation of Figure 7.1. This illustration shows how an object (actually the reference to it) is returned to the calling program.

We will be seeing more examples of object-returning methods in this and later chapters.

Hints, & Tips, Pitfalls



It is not necessary to create an object for every variable we use. Many novice programmers often make this mistake. For example, we write

```
Fraction f1, f2;
f1 = new Fraction(24, 36);
f2 = f1.simplify( );
```

We didn't write

```
Fraction f1, f2;
f1 = new Fraction(24, 36);
f2 = new Fraction(1, 1); //not necessary
f2 = f1.simplify( );
```

because it is not necessary. The *simplify* method returns a **Fraction** object, and in the calling program, all we need is a name we can use to refer to this returned **Fraction** object. Don't forget that the object name (variable) and the actual object instance are two separate things.

Quick CHECK ✓

1. What's wrong with the following declaration?

```
class Question {
    Person student;

    public void getStudent( ) {
        return student;
    }

    ...
}
```

2. Define a Vehicle class. It has a data member owner of type Person. Include an accessor to retrieve the owner person and a mutator to set the owner.

7.2 | The Reserved Word this

Let's continue the implementation of the Fraction class. We now consider the four arithmetic operations for fractions; see Figure 7.3. When defining the methods for the four arithmetic operations, we introduce the use of the reserved word *this*. The

$$\text{Addition } \frac{a}{b} + \frac{c}{d} = \frac{ad + bc}{bd} \qquad \text{Subtraction } \frac{a}{b} - \frac{c}{d} = \frac{ad - bc}{bd}$$

$$\text{Division } \frac{a}{b} \div \frac{c}{d} = \frac{ad}{bc} \qquad \text{Multiplication } \frac{a}{b} \times \frac{c}{d} = \frac{ac}{bd}$$

Figure 7.3 Rules for adding, subtracting, multiplying, and dividing fractions.

self-referencing pointer

reserved word **this** is called a *self-referencing pointer* because it is used to refer to the receiving object of a message from within this object's method.

Let's start with the add method that adds two fractions:

Explicit use of the reserved word **this**

```
public Fraction add( Fraction frac) {
    int a, b, c, d;
    Fraction sum;

    a = this.getNumerator(); //get the receiving
    b = this.getDenominator(); //object's num and denom

    c = frac.getNumerator(); //get frac's num
    d = frac.getDenominator(); //and denom

    sum = new Fraction(a*d + b*c, b*d);

    return sum;
}
```

Let's first look at how this add method is used. The following code adds two fractions f1 and f2 and assigns the sum to f3:

```
Fraction f1, f2, f3;

f1 = new Fraction(1, 2);
f2 = new Fraction(1, 4);

f3 = f1.add(f2);

System.out.println("Sum of " + f1.toString() + " and " +
    f2.toString() + " is " +
    f3.toString());
```

This code, when executed, will produce the following output:

```
Sum of 1/2 and 1/4 is 6/8
```

Not simplified because the **simplify** method is not called.

In the statement

```
f3 = f1.add(f2);
```

we are calling the add method of f1 and passing the argument f2. So in this case, the receiving object is f1. Figure 7.4 shows the state of memory at the point where the add method of f1 is called. Notice that the self-referencing pointer this is referring to f1 because it is the receiving object.

Because f2 is also a Fraction object, we can write the statement as

```
f3 = f2.add(f1);
```

and get the same result (since the operation is addition). In this case, the receiving object is f2, and the argument is f1. Figure 7.5 shows the state of memory at the point where the add method of f2 is called. Notice how the objects referenced by frac and this are swapped. This time the self-referencing pointer this is referring to f2.

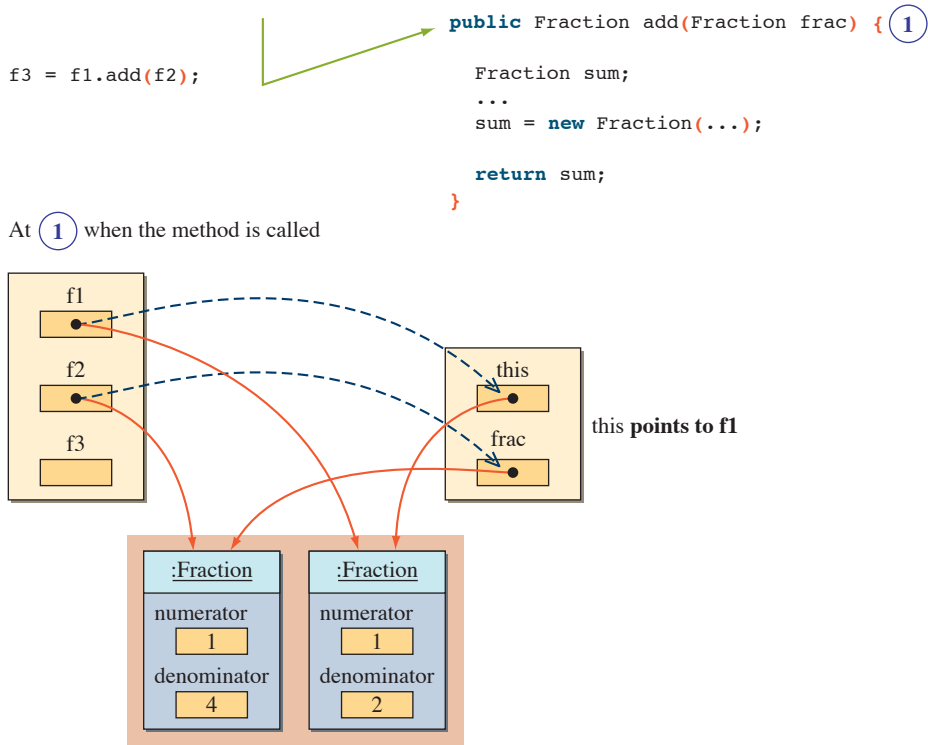

Figure 7.4 This illustration shows the state of memory for **f1.add(f2)**.

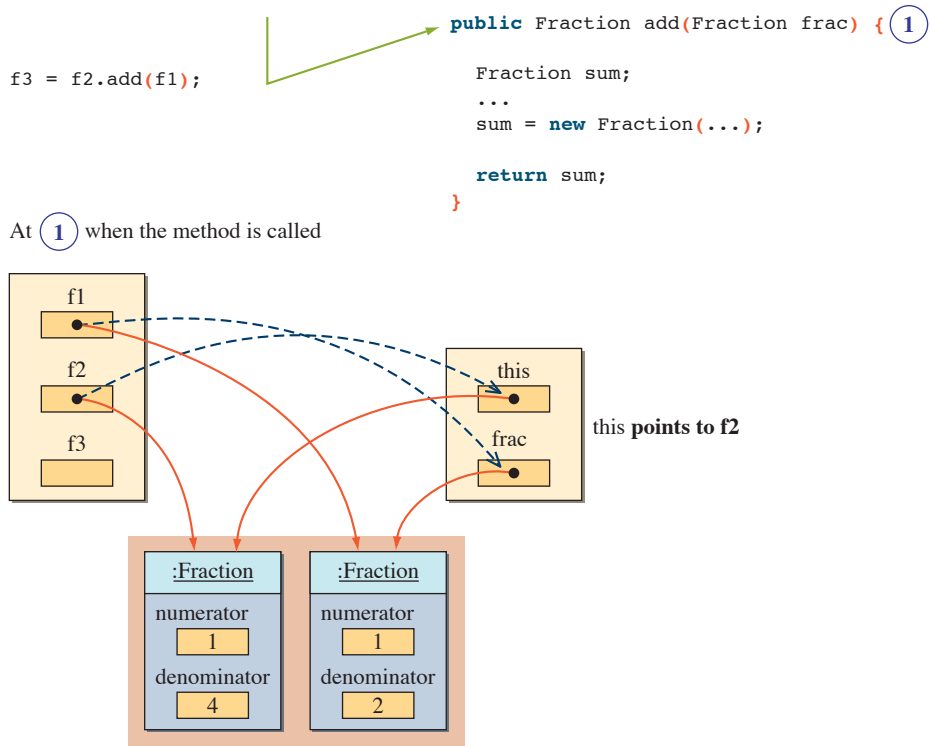

Figure 7.5 This illustration shows the state of memory for `f2.add(f1)`.

The `add` method computes the sum of the receiving `Fraction` object and the argument `Fraction` object. We used the identifier `frac` for the parameter, so

```
c = frac.getNumerator();
d = frac.getDenominator();
```

will retrieve the numerator and the denominator of the argument `Fraction` object.

To retrieve the numerator and the denominator of the receiving `Fraction` object, we write

```
a = this.getNumerator();
b = this.getDenominator();
```

because the reserved word `this` refers to the receiving object.

The use of the reserved word `this` is actually optional. If we do not include it explicitly, then the compiler will insert the reserved word for us. For example, if we write

```
class Sample {
    public void m1( ) {
        ...
    }
    public void m2( ) {
        m1();
    }
}
```

then the compiler will interpret the definition as

```
class Sample {
    public void m1( ) {
        ...
    }
    public void m2( ) {
        this.m1();
    }
}
```

The reserved word `this` is added by the compiler.

This is the reason why we were able to call a method from another method of the same class without the use of dot notation. In fact, it was dot notation with the reserved word `this`. We will discuss the use of `this` when referring to data members of class at the end of this section.

The methods for the other three arithmetic operations are defined in a similar manner:

```
public Fraction divide(Fraction frac) {
    int a, b, c, d;

    Fraction quotient;

    a = this.getNumerator();
    b = this.getDenominator();
    c = frac.getNumerator();
    d = frac.getDenominator();

    quotient = new Fraction(a*d, b*c);

    return quotient;
}
```

```

public Fraction multiply(Fraction frac) {
    int a, b, c, d;

    Fraction product;

    a = this.getNumerator();
    b = this.getDenominator();
    c = frac.getNumerator();
    d = frac.getDenominator();

    product = new Fraction(a*c, b*d);

    return product;
}

public Fraction subtract(Fraction frac) {
    int a, b, c, d;

    Fraction diff;

    a = this.getNumerator();
    b = this.getDenominator();
    c = frac.getNumerator();
    d = frac.getDenominator();

    diff = new Fraction(a*d - b*c, b*d);

    return diff;
}

```

We could have defined the four arithmetic methods as void methods, instead of returning the result as a Fraction object. But doing so will severely limit the flexibility. Because the methods are object-returning methods, we can write a statement such as

```
f3 = f1.add(f2);
```

that reflects the mathematical expression

$$f3 = f1 + f2$$

naturally. Moreover, because the add method returns a Fraction object as the sum, we can compose the calls to implement multiple additions. For example, the mathematical expression

$$f4 = f1 + f2 + f3$$

can be written as

```
f4 = f1.add( f2.add(f3) );
```

where the sum of `f2` and `f3` is passed as an argument to the `add` method of `f1`. We can also write the expression as

```
f4 = f1.add(f2).add(f3);
```

because `f1.add(f2)` refers to a (unnamed) `Fraction` object, and we can call this unnamed object's `add` method with `f3` as an argument.

Another Use of `this`

Consider the following class declaration:

```
class MusicCD {
    private String  artist;
    private String  title;

    private String  id;

    public MusicCD(String name1, String name2) {
        artist = name1;
        title  = name2;
        id     = artist.substring(0,2) + "-" +
                title.substring(0,9);
    }
    ...
}
```

The constructor has two `String` parameters, one for the artist and another for the title. An `id` for a `MusicCD` object is set to be the first two letters of the artist name followed by a hyphen and the first nine letters of the title.

Now, consider what happens if we include (say, inadvertently) a local declaration for the identifier `id` like this:

Local declaration
for `id`.

This `id` is now a
local variable.

```
public MusicCD(String name1, String name2) {
    String id;

    artist = name1;
    title  = name2;
    id     = artist.substring(0,2) + "-" +
            title.substring(0,9);
}
```

Because there is a matching local declaration for `id`, the identifier refers to the local variable, not to the third data member anymore. When an identifier is encountered in a method, the following rules are applied to determine the association.

Things to Remember



Rules for associating an identifier to a local variable, a parameter, and a data member

1. If there's a matching local variable declaration or a parameter, then the identifier refers to the local variable or the parameter.
2. Otherwise, if there's a matching data member declaration, then the identifier refers to the data member.
3. Otherwise, it is an error because there's no matching declaration.

Why does the Java compiler not catch such an error? When would anyone want to use the same identifier for both the data member and the local variable or parameter? It is true that we strongly recommend to always use an identifier different from any data member in declaring a local variable. But there is a situation in which we may want to use the same identifier for a parameter and a data member. In the `MusicCD` constructor, we declared the parameters `name1` and `name2` to avoid naming conflict. It would actually be more meaningful to use the conflicting identifiers `artist` and `title`. To do so, we rewrite the method by using the reserved word `this` as follows.

```

public MusicCD(String artist, String title) {
    this.artist = artist;
    this.title = title;
    id = artist.substring(0,2) + "-" +
        title.substring(0,9);
}

```

This refers to the data member. This refers to the parameter.

Following the stated rules, the identifier `artist` refers to the parameter. To refer to the data member `artist` from within this constructor, we prefix the identifier `artist` with the reserved word `this`, using dot notation, as `this.artist`. In the modified constructor, we did not use the reserved word `this` to refer to the data member `id` because it was not necessary. Its use is optional, so we could have written

```

this.id = artist.substring(0,2) + "-" +
        title.substring(0,9);

```

to make the code look more consistent. The reserved word `this` can always be used to refer to the receiving object's data members, whether there is a naming conflict or not.

Things to Remember



Optionally, dot notation with the reserved **this** can be used to refer to an object's data member from the object's methods and constructors.

In general, following the common practice, we do not use dot notation (with the reserved word `this`) to refer to an object's data members from the object's methods unless it is necessary.

Note that we can also avoid the naming conflict and still use a meaningful name for a parameter by prefixing an article to the parameter. For example, we could use the identifiers `anArtist` and `aTitle` instead of `name1` and `name2`. This naming will not conflict with the data members, so the use of the reserved word `this` is not necessary in the constructor. As long as you use meaningful identifiers, which technique you adopt to avoid naming conflict is more of a personal preference.



1. Write a single statement to express the following operations on fractions, using the methods from the `Fraction` class.

$$f5 = (f1 + f2) / (f3 - f4)$$

2. If the `add` method is defined thus

```
public void add(Fraction frac) {
    int a, b, c, d;

    a = this.getNumerator(); //get this fraction's
    b = this.getDenominator(); //num and denom

    c = frac.getNumerator(); //get frac's num
    d = frac.getDenominator(); //and denom

    setNumerator(a*b + c*b); //updates this
    setDenominator(b*d); //fraction's num and denom
}
```

why is it wrong to call the method as follows?

```
f3 = f1.add(f2);
```

3. Write statements to assign the sum of fractions `f1` and `f2` to fraction `f3`, using the `add` method defined in question 2.

7.3 Overloaded Methods and Constructors

Let's continue to improve the `Fraction` class. Given the `Fraction` class in its current form, how can a client programmer express the following mathematical expression?

$$f3 = 2/3 + 9$$

One way is to convert the integer 9 to a fraction 9/1 and then use the add method.

```
Fraction f1, f2, f3;

f1 = new Fraction(2, 3);
f2 = new Fraction(9, 1);

f3 = f1.add(f2);
```

This is not bad, but it would be nicer if we could write something like this:

```
Fraction f1, f3;

f1 = new Fraction(2, 3);

f3 = f1.add(9);
```

In other words, instead of passing a Fraction object, we want to pass a simple integer value. Of course, with the current Fraction class, the statement

```
f3 = f1.add(9);
```

will result in an error because no matching method is defined in the class. So what we want here is two versions of addition, one that accepts a Fraction object and another that accepts an integer. Here are the two definitions:

```
//Version 1
public Fraction add(Fraction frac) {

    //same as before

}

//Version 2
public Fraction add(int number) {

    Fraction sum;
    int a, b, c, d;

    a = getNumerator();
    b = getDenominator();
    c = number;
    d = 1;

    sum = new Fraction(a*d + c*b, b*d);
    return sum;

}
```

Including `d` here is redundant because its value is 1. We include it here anyway for the sake of clarity.

overloaded
methods

With the second add method, we now have two methods in the class that have the same name. This is not a problem as long as certain rules are met. The methods having the same name are called *overloaded methods*.

Multiple methods can share the same name as long as one of the following rules is met:

1. They have a different number of parameters.
2. The parameters are of different data types when the number of parameters is the same.

The two `add` methods of the `Fraction` class satisfy the second rule. The following is an example in which two methods satisfy the first rule:

```
public void myMethod(int x, int y) { ... }
public void myMethod(int x) { ... }
```

method
signature

More formally, we say two methods can be overloaded if they do not have the same signature. The *method signature* refers to the name of the method and the number and types of its parameters. The two `myMethod` methods have different signatures because the data types of the second parameter are different.

Two methods cannot be overloaded just by the different return types because two such methods would have the same signature. For example, the following two methods cannot be defined in the same class:

```
public double getInfo(String item) { ... }
public int    getInfo(String item) { ... }
```

Now, let's look at the second `add` method again. Instead of defining it as we have, we can define it by calling the first `add` method. Here's how:

```
//More concise Version 2
public Fraction add(int number) {
    Fraction frac = new Fraction(number, 1);
    Fraction sum = add(frac); //calls the first add method
    return sum;
}
```

In defining overloaded methods, it is common for one of them to call another. Such implementation indicates their relationship clearly—that they are different versions of the same logical operation. It also makes the modification easier because we need to change the code in only one method. Other methods calling this method require no changes. We can define the overloaded methods for the other three arithmetic operations in a similar manner.

Overloading Constructors

Up until now, our programmer-defined classes included exactly one constructor. But a constructor is also a method, so it, too, can be overloaded. Indeed, it is much

multiple
constructors

more common to define *multiple constructors* in a programmer-defined class. The same rules for overloaded methods apply. Defining multiple constructors for a class gives the client programmer flexibility in creating instances. The client programmer can pick one of the several constructors that is suitable for her needs at hand. Let's define multiple constructors for the Fraction class. Here are the four constructors (including the one already defined before at the bottom):

```
public Fraction( ) { //creates 0/1
    setNumerator(0);
    setDenominator(1);
}

public Fraction(int number) { //creates number/1
    setNumerator(number);
    setDenominator(1);
}

public Fraction(Fraction frac) { //copy constructor
    setNumerator(frac.getNumerator());
    setDenominator(frac.getDenominator());
}

public Fraction(int num, int denom) {
    setNumerator(num);
    setDenominator(denom);
}
```

copy
constructor

The third constructor that accepts a Fraction object and creates a copy of the passed Fraction object is called a *copy constructor*. A copy constructor can be quite handy when we need to create instances of a class that includes many data members. Often we want to create a copy before changing the values of or experimenting with the original object.

As another example, here's a Bicycle class with two constructors that initialize the two data members:

```
class Bicycle {

    // Data Members

    private String id;

    private String ownerName;

    // Constructors
    public Bicycle( ) {

        id = "XXXX-XXXX";
        ownerName = "Unassigned";
    }
}
```

```

public Bicycle(String tagNo, String name) {
    id = tagNo;
    ownerName = name;
}
//the rest of the class
. . .
}

```

Calling a Constructor From Another Constructor by Using `this`

The last use of the reserved word `this` is to call a constructor from another constructor of the same class. Here's how we can rewrite the four constructors of the `Fraction` class by using the reserved word `this`:

```

public Fraction( ) { //creates 0/1
    this(0, 1);
}

public Fraction(int number) { //creates number/1
    this(number, 1);
}

public Fraction(Fraction frac) { //copy constructor
    this( frac.getNumerator(),
          frac.getDenominator() );
}

public Fraction(int num, int denom) {
    setNumerator(num);
    setDenominator(denom);
}

```

This constructor is called by the other three constructors.

The syntax for calling a constructor from another constructor of the same class is

```
this( <parameter-list> );
```

The constructor that matches the parameter list will be called. We can add more statements after the `this` statement in a constructor, but not before it. In other words, the call to `this` in a constructor must be the first statement of the constructor.

Things to Remember



When you use `this` to call a constructor from another constructor of the same class, the `this` statement must be the first statement in the constructor.

Quick CHECK



1. Are there any conflicts in the following three constructors for ClassX to be valid?

```
public ClassX( int X ) {
    ...
}
public ClassX( float X ) {
    ...
}
public ClassX( int Y ) {
    ...
}
```

2. Define a Student class. A Student has a name. Define two constructors, one with no argument and another with the name as its argument. Initialize the name to a default value Unknown for the zero-argument constructor.
3. Rewrite the following constructors, so the first one calls the second one.

```
public ClassOne(int alpha) {
    this.alpha = alpha;
    this.beat = 0;
}
public ClassOne(int alpha, int beta) {
    this.alpha = alpha;
    this.beta = beta;
}
```

7.4 | Class Variables and Methods

We introduced the concepts of class methods, class variables, and class constants in Chapter 1. We saw how class constants are declared in the actual Java statements in Chapter 4. We complete our study of class components in this section by describing how class methods and class variables are used in Java programs. Let's begin with the class methods.

The Math class includes a class method called min to compare two numbers. We use this class method as follows:

```
int i, j, smaller;
i = ...;
j = ...;
smaller = Math.min(i, j);
```

Now suppose we want to have a method to find the smaller of two Fraction objects. Where do we define such a method? The logical place is, of course, the Fraction class. But will this method be an instance method? No, a class method, which follows the pattern of the min method of the Math class, is most appropriate. We can define a class method called min that accepts two Fraction objects as arguments and returns the smaller fraction. Here's how we define the min method:

```
class Fraction {
    ...
    public static Fraction min(Fraction f1, Fraction f2) {
        //convert to decimals and then compare
        double f1_dec = f1.decimal();
        double f2_dec = f2.decimal();
        if ( f1_dec <= f2_dec ) {
            return f1;
        } else {
            return f2;
        }
    }
    private double decimal( ) {
        //returns the decimal equivalent
        return (double) getNumerator() / getDenominator();
    }
    ...
}
```

The reserved word static indicates that the min method is a class method. A class method is called by using dot notation with the class name. Here's a sample use:

```
Fraction f1, f2, smaller;
f1 = new Fraction(1, 6);
f2 = new Fraction(4, 5);
smaller = Fraction.min(f1, f2);
```

Remember, in Chapter 6 we discussed the need for finding the greatest common divisor of two integers to simplify a given fraction. Following the logic of the min method, we can define the gcd method as a class method. Here's how:

```
public static int gcd(int m, int n) {
    //the code implementing the Euclidean algorithm
}
```

Notice that the arguments to this method are two integers. When this method is called from another method of the `Fraction` class, the numerator and the denominator are passed as the arguments. We declare this method `public` so the client programmers of the `Fraction` class can use it also. If this is not necessary, then we can declare it `private`. (*Note*: Logically, the `gcd` method should be a class method, but there will be no serious consequences if we define it as an instance method.)

In a manner similar to the `min` and `gcd` methods, we can define the methods for arithmetic operations as class methods. For example, here's how:

```
public static Fraction add(Fraction f1, Fraction f2) {
    int a, b, c, d;
    Fraction sum;
    a = f1.getNumerator();
    b = f1.getDenominator();
    c = f2.getNumerator();
    d = f2.getDenominator();
    sum = new Fraction(a*d + b*c, b*d);
    return sum;
}
```

To use this class method, we write something like this:

```
Fraction x = new Fraction(1, 8);
Fraction y = new Fraction(4, 9);
Fraction sum = Fraction.add(x, y);
```

The class method `add`, however, becomes awkward when we try to compose additions. To add three fractions `x`, `y`, and `z`, for example, we have to write

```
Fraction sum = Fraction.add(Fraction.add(x,y), z);
```

The instance method `add`, as we defined at the beginning of the chapter, allows a lot more natural and flexible use.

Now let's look at an example of class variables (we have been using class constants since Chap. 4). Suppose we want to assign a tag number automatically when a new instance of the `Bicycle` class is created. We want the tag numbers to be `ABC-101`, `ABC-102`, `ABC-103`, and so forth. What we need to define in the `Bicycle` class is a counter that counts up from 101. Only one counter is necessary for the whole class, so it is logical to define this counter as a class variable.

First, we declare and initialize the class variable counter:

```
class Bicycle {
    private static int counter = 101;
    ...
}
```

Then we adjust the constructor, so the id of a bicycle is assigned correctly. Here's how:

```
public Bicycle( ) {
    id = "ABC-" + counter;
    ...
    counter++;
}
```

Static Initializer

There are cases in which we may need to do more than a simple assignment to initialize a class variable. For example, we may be required to read the starting value for the class variable counter of the Bicycle class from a file. If we need to perform more than a simple assignment to initialize a class variable, then we define a static initializer. A *static initializer* is a code that gets executed when a class is loaded into the Java system. It is defined in the following manner:

static initializer

```
class XYZ {
    ...
    static {
        //code to initialize
        //class variables and perform
        //other tasks
    }
    ...
}
```

As an illustration, here's how we define the static initializer for the Bicycle class to set the starting value of counter to 101:

```
class Bicycle {
    private static int counter;
    ...
    static {
        counter = 101;
    }
    ...
}
```

We conclude this section with important reminders.

Things to Remember



1. Class methods can access only the class variables and the class constants of the class.
2. Instance methods, including constructors, can access all types of data members.
3. Class methods cannot call instance methods of the same class.
4. Instance methods can call all other methods of the same class.

7.5 Call-by-Value Parameter Passing

We will provide more detailed coverage on how arguments are passed to a method. Let's first review some key facts. Local variables are used for temporary purposes, such as storing intermediate results of a computation. While the data members of a class are accessible from all instance methods of the class, local variables and parameters are accessible only from the method in which they are declared, and they are available only while the method is being executed. Memory space for local variables and parameters is allocated upon declaration and at the beginning of the method, respectively, and erased upon exiting from the method.

When a method is called, the value of the argument is passed to the matching parameter, and separate memory space is allocated to store this value. This way of passing the value of arguments is called a *pass-by-value* or *call-by-value scheme*. Since separate memory space is allocated for each parameter during the execution of the method, the parameter is local to the method, and therefore changes made to the parameter will not affect the value of the corresponding argument.

Consider the following `myMethod` method of the `Tester` class. The method does not do anything meaningful. We use it here to illustrate how the call-by-value scheme works.

```
class Tester {
    public void myMethod(int one, double two ) {
        one = 25;
        two = 35.4;
    }
}
```

What will be the output from the following code?

```
Tester tester;
int x, y;

tester = new Tester();
x = 10;
y = 20;

tester.myMethod( x, y );

System.out.println( x + " " + y );
```

call-by-value
scheme

The output will be

```
10    20
```

because with the pass-by-value scheme, the values of arguments are passed to the parameters, but changes made to the parameters are not passed back to the arguments. Figure 7.6 shows how the pass-by-value scheme works.

Notice that the arguments are matched against the parameters in the left-to-right order; that is, the value of the leftmost argument is passed to the leftmost parameter, the value of the second-leftmost argument is passed to the second-leftmost parameter, and so forth. The number of arguments in the method call must match the number of parameters in the method definition. For example, the following calls to `myMethod` of the `Tester` class are all invalid because the number of arguments and number of parameters do not match.

```
tester.myMethod( 12 );
tester.myMethod( x, y, 24.5 );
```

Since we are assigning the value of an argument to the matching parameter, the data type of an argument must be assignment-compatible with the data type of the matching parameter. For example, we can pass an integer argument to a float parameter, but not vice versa. In the following, the first call is valid, but the second one is invalid:

```
tester.myMethod( 12, 25 );
tester.myMethod( 23.0, 34.5 );
```

The name of the parameter and the name of the argument can be the same. Keep in mind, however, that the values of arguments are still passed to a method by the pass-by-value scheme; that is, local copies are made whether the argument and the parameter share the same name or not.

Things to Remember



Remember these key points about arguments and parameters:

1. *Arguments are passed to a method by using the pass-by-value scheme.*
2. *Arguments are matched to the parameters from left to right. The data type of an argument must be assignment-compatible with the data type of the matching parameter.*
3. *The number of arguments in the method call must match the number of parameters in the method definition.*
4. *Parameters and arguments do not have to have the same name.*
5. *Local copies, which are distinct from arguments, are created even if the parameters and arguments share the same name.*
6. *Parameters are input to a method, and they are local to the method. Changes made to the parameters will not affect the value of corresponding arguments.*

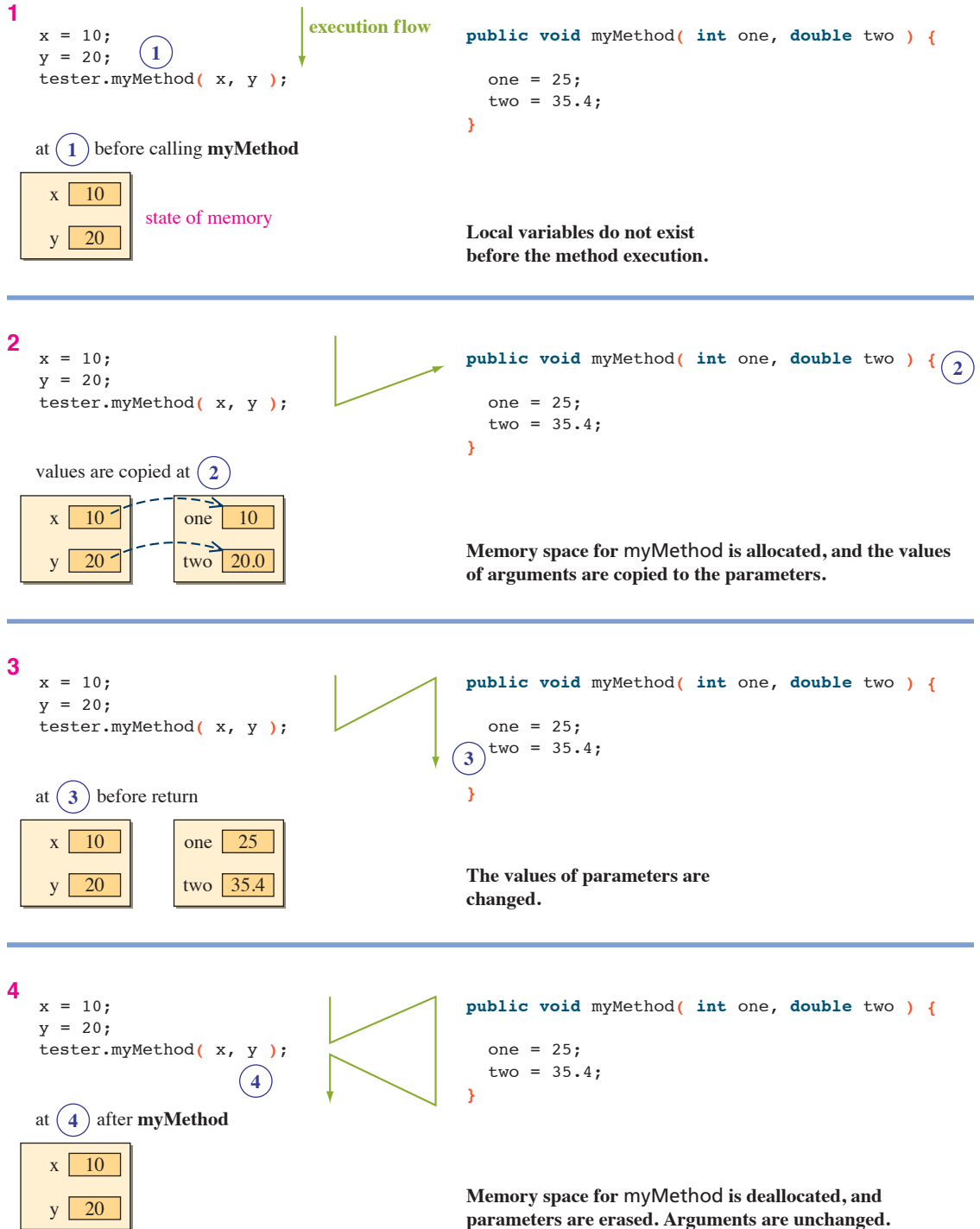

Figure 7.6 How memory space for the parameters is allocated and deallocated.

Now let's look at a similar example again, but this time with objects. Consider the following class:

```
class ObjectTester {
    public void swap(Fraction f1, Fraction f2) {
        Fraction temp;
        temp = f1; //swap the two fractions
        f1 = f2;
        f2 = temp;
    }
}
```

What will be the output from the following code?

```
ObjectTester tester;
Fraction x, y;

tester = new ObjectTester();

x = new Fraction(1, 2);

y = new Fraction(3, 4);

tester.swap(x, y);

System.out.println("x = " + x.toString());
System.out.println("y = " + y.toString());
```

The output will be

```
x = 1/2
y = 3/4
```

because the changes made to the parameters are not passed back to the arguments. It does not matter whether we are passing primitive data values or objects (actually, references to the objects). Figure 7.7 shows the effect of calling the swap method.

Changes made to the parameters are not passed back to the arguments, but when we are passing objects to a method, then the changes made to the object itself are reflected back to the caller because the calling side still has the same reference to the object. Let's look at an example. Consider the following class:

```
class ObjectTester2 {
    public void change(Fraction f1) {
        f1.setNumerator(10);
    }
}
```

At the beginning of the **swap** method.

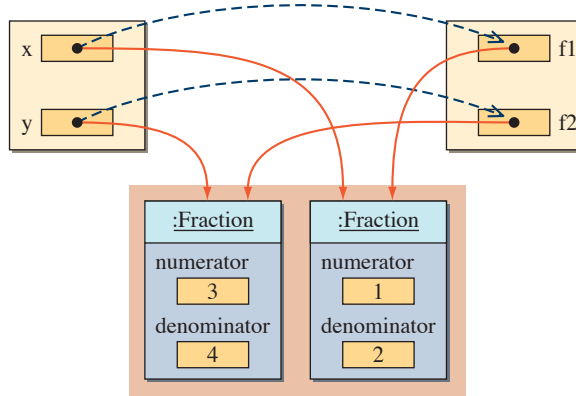

At the end of the **swap** method when **f1** and **f2** are swapped.

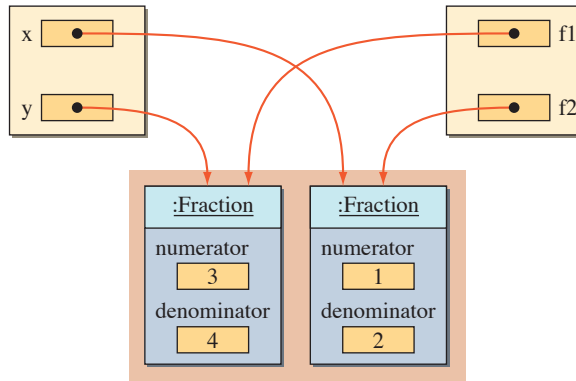

After the **swap** method terminates. No changes made to parameters **f1** and **f2** are reflected back to the arguments. Both **x** and **y** still point to the same objects as before the call.

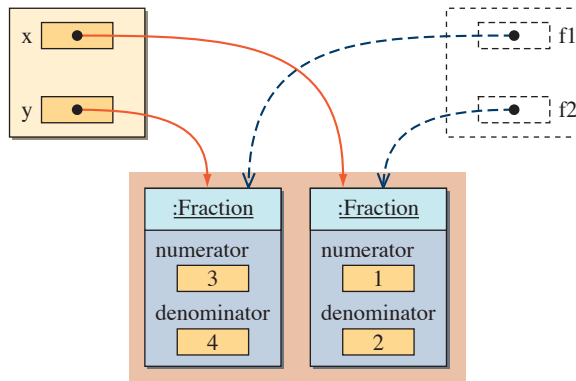

Figure 7.7 This illustration shows the effect of calling the **swap** method.

What will be the output from the following code?

```
ObjectTester2 tester;
Fraction      x;

tester = new ObjectTester();
x = new Fraction(1, 2);
tester.change(x);
System.out.println("x = " + x.toString());
```

The output will be

```
x = 10/2
```

Figure 7.8 shows the effect of calling the `change` method. Notice that the variable `x` continues to point to the same object, but the object itself has been modified.

You Might Want to Know



Pass-by-value (also known as call-by-value) is the *only* parameter passing mechanism Java supports. Because we are passing references when objects are passed to methods, many people with background in other programming languages use the term *pass by reference* (or *call by reference*) when referring to the passing of objects to methods. This is *wrong*. Pass by reference means an address (or reference) of a variable is passed, whereas pass by value means the content of a variable is passed (and copied into a parameter). In Java, the content of a variable is either a value of primitive data type or a reference to an object (this is the source of confusion). But it doesn't matter what the content of a variable is; as long as the content of a variable is passed and copied into a parameter, it is a call by value. If a programming language supports the pass-by-reference mechanism, then it is possible, for example, to swap the values of two arguments in a single method call. No such thing is possible in Java.

Quick CHECK

1. What is the name of the scheme used in Java to pass arguments to a method?
2. What is the output from the following code?

```
class Question {
    private int one;

    public void myMethod( int one ) {
        this.one = one;
        one = 12;
    }
}
```

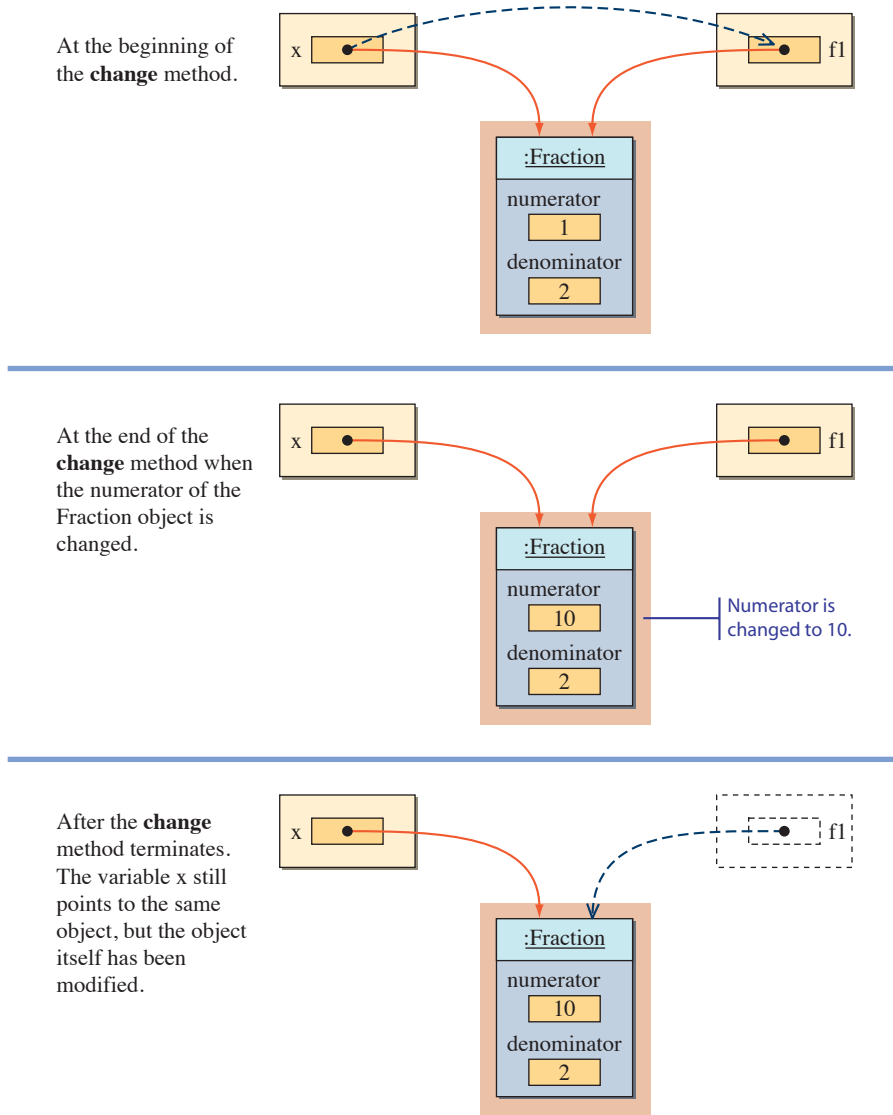

Figure 7.8 This illustration shows the effect of calling the **change** method.

```

class Test {
    public static void main(String[] arg) {
        int one = 30;

        Question q = new Question();
        q.myMethod(one);

        System.out.println(one);
    }
}

```

7.6 Organizing Classes into a Package

For simplicity, we have placed all programmer-defined classes of a program in the same folder since Chapter 4. This approach works fine while we are learning programming and do not deal with many classes. But in a more real-life context, we need to manage classes more effectively. For example, following the approach, we have to copy the `Fraction` class to multiple folders if we want to use this class in different programs.

The correct approach to reusing programmer-defined classes is to organize them into packages, just as the standard classes are organized into packages. We illustrate the process by using the `Fraction` class. Let's name the package to place the `Fraction` class `myutil`. It is a Java convention to name the package with all lowercase letters. Once this package is set up correctly, we can use the classes in the package by importing it, just as we have been doing with the standard packages.

```
import myutil.*;

class MyClient {
    Fraction f1;
    ...
}
```

programmer-
defined
packages

To set up the *programmer-defined packages* for general reuse, not just use by the programs in the same folder, we have to perform the following tasks:

1. Include the statement

```
package myutil;
```

as the first statement of the source file for the `Fraction` class.

2. The class declaration must include the visibility modifier `public` as

```
public class Fraction {
    ...
}
```

3. Create a folder named `myutil`, the same name as the package name. In Java, the package must have a one-to-one correspondence with the folder.
4. Place the modified `Fraction` class into the `myutil` folder and compile it.
5. Modify the `CLASSPATH` environment variable to include the folder that contains the `myutil` folder. See below.

Step 5 is the most troublesome step for those new to Java. Since the exact steps to change the `CLASSPATH` environment variable are different from each platform (Windows, Unix, Mac) and Java IDE (Eclipse, NetBeans, jGRASP, BlueJ, etc.), we will describe only the general idea for the Windows platform here. Suppose we have a folder named `JavaPrograms` under the C: drive, and the `myutil` package (folder) is placed inside this `JavaPrograms` folder. Then to use the classes in

the `myutil` package, the classpath environment should make a reference to the `JavaPrograms` folder (not to the package `myutil` itself):

```
set classpath=.;c:\JavaPrograms
```

The period after the equals symbol refers to the current folder (the folder where the client program we are trying to execute is located). Without this reference to the current folder, the client program will not recognize other classes in the same folder.

Things to Remember



To make the programmer-defined packages accessible to all client programs, the **CLASSPATH** environment variable must be set up correctly.

javadoc
comments

7.7 | Using Javadoc Comments for Class Documentation

We mentioned in Chapter 2 that there are three styles of comments in Java. We have been using the two of them. We introduce the third style called *javadoc comments* in this section. Many of the programmer-defined classes we design are intended to be used by other programmers. It is, therefore, very important to provide meaningful documentation to the client programmers so they can understand how to use our classes correctly. By adding javadoc comments to the classes we design, we can provide a consistent style of documenting the classes. Once the javadoc comments are added to a class, we can use a special program (comes as a part of Java 2 SDK) to generate HTML files for documentation. (*Note:* An HTML file is a specially marked file intended for a Web browser.) We mentioned in Chapter 2 that the documentation for the standard classes can be found at <http://java.sun.com/javase/6/docs/api/>.

This documentation is derived from the javadoc comments embedded in the standard classes.

We will describe how to use javadoc comments and generate the corresponding HTML documentation files. Before we get into the details, we first show the end result so you can visualize where the process is leading. Figure 7.9 shows a portion of the HTML documentation for the `Fraction` class displayed in a browser.

A javadoc comment is used as header comment for a class, a data member, or a method. Let's begin with the class header comment for the `Fraction` class in the javadoc format:

```
/**
 * An instance of this class represents a fraction.
 *
 * @author Dr. Caffeine
 *
 */
class Fraction {
    ...
}
```

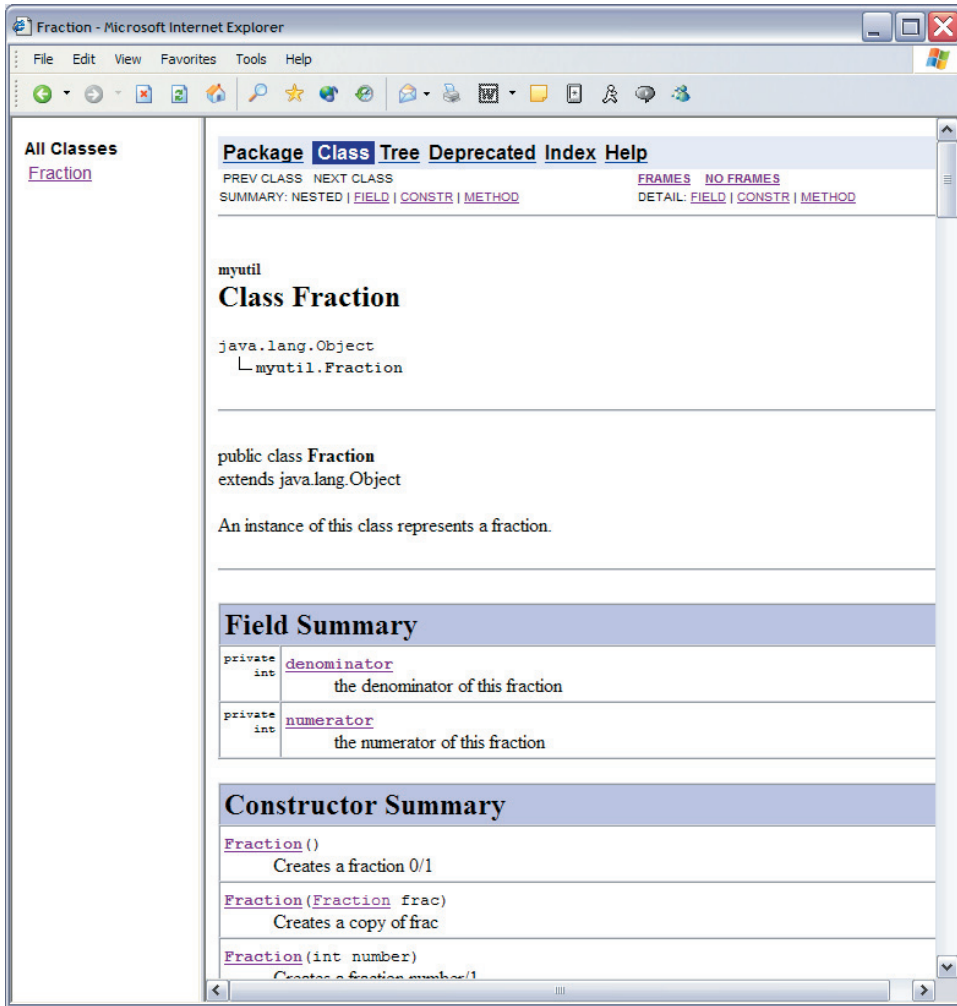



Figure 7.9 A browser showing the HTML documentation file derived from the javadoc comments for the **Fraction** class.

The javadoc comments begin with the marker `/**` and end with the marker `*/`. The asterisks on the lines between the first and the last markers have no significance; they are there to provide a visual aid to highlight the comments in the program. It is an accepted standard to use the asterisks in this manner for the javadoc comments.

javadoc tags

@author tag

Inside the javadoc comments, we can use a number of *javadoc tags*, special markers that begin with the `@` mark. In this example, we see one javadoc tag `@author`, which we use to list the authors of the class.

Here's how we comment a data member in javadoc:

```
/**
 * The numerator portion of this fraction
 */
private int numerator;
```

When the length of a comment is short and fits in a single line, then we can write the javadoc comment as

```
/** The numerator portion of this fraction */
private int numerator;
```

The javadoc comment for a method is similar to the one for the class header comment. It will include a number of javadoc tags in addition to a general description. Here's how a method is commented by using javadoc:

```
/**
 * Returns the sum of this Fraction
 * and the parameter frac. The sum
 * returned is NOT simplified.
 *
 * @param frac the Fraction to add to this
 *         Fraction
 *
 * @return the sum of this and frac
 */
public Fraction add(Fraction frac) {
    ...
}
```

@param tag

The purpose of the method header comment is to record the method's purpose, list of parameters passed to the method, and value returned from the method. This method receives one parameter, so there is one **@param tag**. We attach a short description of the parameter in addition to the parameter's name. The syntax for the **@param** javadoc tag is

```
@param <parameter name> <description>
```

@return tag

The **<description>** portion can go beyond one line. As this method returns a value, we add the **@return tag**. Its syntax is

```
@return <description>
```

A javadoc comment for a constructor is defined in a manner similar to the one for a method, except there will never be an **@return** tag for a constructor. Figure 7.10 shows the HTML document that is generated from this javadoc comment. Notice the effect of **@param** and **@return** tags.

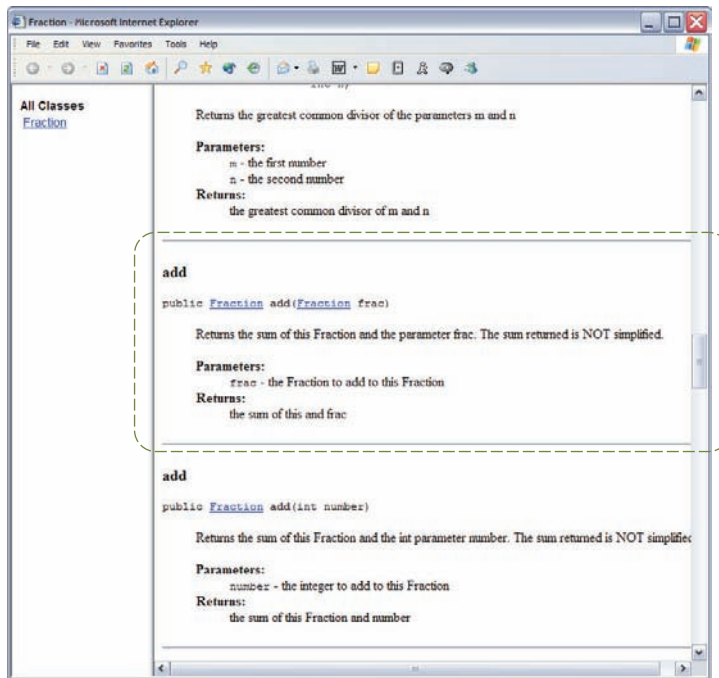

Figure 7.10 The portion of the HTML documentation file that is derived from the javadoc header comment for the **add** method.

The use of the javadoc comments does not preclude the use of other types of comments. We still need to use regular comments to describe the code as necessary. For example, we will continue to include the group comment for methods, as in

```
//-----
//  Public Methods:
//
//      Fraction add ( Fraction )
//      Fraction add ( int      )
//
//      ...
//-----
```

so that programmers reading the class will have a handy reference to the list of methods without referring to any online documentation. This is especially useful when the programmers are reading a hard copy of the class source file. Notice that we don't use the javadoc style for a quick reference list because javadoc comments are used only for describing the class and its data members and methods.

Once all the javadoc comments are added to a class, we are ready to generate the corresponding HTML documentation file. For easy reference, we call it the

javadoc file. Many Java editors and IDEs include a menu option that you can use to generate javadoc files easily and quickly. Here we describe the steps you can take to generate javadoc files using the minimalist approach (see App. A). In the command prompt window, we used the commands `javac` and `java` to compile and run Java programs, respectively. Similarly, to generate javadoc files, we use the `javadoc` command. For example, to generate a javadoc file for the `Fraction` class, we enter

```
javadoc -private Fraction.java
```

We specify the `-private` option because we want to generate the documentation for all types of methods (so far, we have covered two of these—`private` and `public`). The `-private` option generates the most complete documentation. When the command is executed, status messages such as these are displayed.

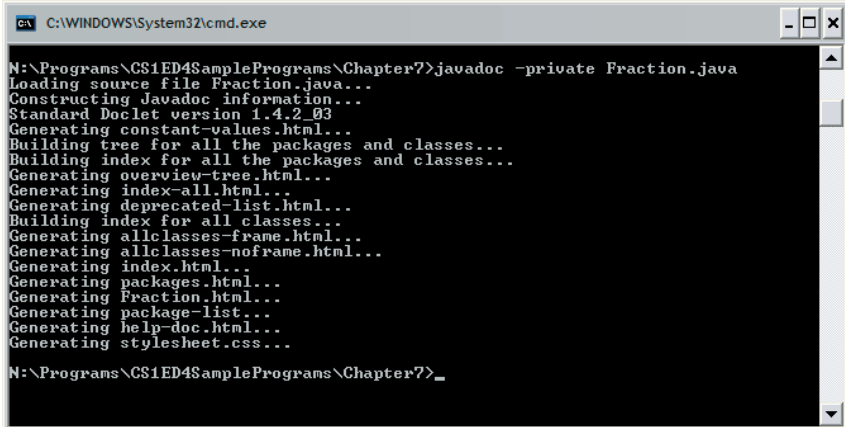
A screenshot of a Windows command prompt window titled "C:\WINDOWS\System32\cmd.exe". The window shows the execution of the command `javadoc -private Fraction.java`. The output consists of several lines of status messages: "Loading source file Fraction.java...", "Constructing Javadoc information...", "Standard Doclet version 1.4.2_03", "Generating constant-values.html...", "Building tree for all the packages and classes...", "Building index for all the packages and classes...", "Generating overview-tree.html...", "Generating index-all.html...", "Generating deprecated-list.html...", "Building index for all classes...", "Generating allclasses-frame.html...", "Generating allclasses-noframe.html...", "Generating index.html...", "Generating packages.html...", "Generating Fraction.html...", "Generating package-list...", "Generating help-doc.html...", and "Generating stylesheet.css...". The prompt ends with `N:\Programs\CS1ED4\SamplePrograms\Chapter7>`.

After the command is executed successfully, there will actually be a collection of HTML files, not just the expected `Fraction.html`. You can view the content shown in Figure 7.9 by opening the file `index.html` and clicking the `Fraction` link. Open the `Fraction.html` directly from your browser and see the difference. We encourage you to open other HTML files to see how these files are related. The generated HTML files are located in the same directory where the source file `Fraction.java` is located. You can change the directory by setting the `-d` option and specifying the directory to store the generated HTML files (alternatively, you can move the files using an operating system's file manager). We ordinarily do not generate javadoc files one class at a time. Rather, it is more common to generate a complete set of javadoc files for all classes in a single package at once, as in

```
javadoc -private *.java
```

We will refer you to websites for a more complete discussion of javadoc.

Things to Remember



General information on javadoc is located at <http://java.sun.com/j2se/javadoc/>
Detailed reference on how to use javadoc on Windows is located at <http://java.sun.com/javase/6/docs/technotes/tools/windows/javadoc.html>

Hints, & Tips, & Pitfalls



Is it really important to use javadoc comments? It's true that we have to learn a few extra items to use javadoc comments, but the benefits warrant a little extra effort. First, by using javadoc comments, we can easily produce the standard online documentation. Even if we don't have an immediate need to produce an online documentation, we can use javadoc comments because they are really not that different from other styles of commenting, and their use gives us an option to produce an online documentation later. Second, since javadoc is a standard, other programmers will have an easier time reading your code with javadoc comments than reading code with a nonstandard style of comments.

Quick CHECK ✓

1. Add javadoc comments to the following class.

```
class Instructor {
    private String name;
    public void setName(String name) {
        this.name = name;
    }
    public String getName( ) {
        return name;
    }
}
```

2. What is the purpose of @author tag?

7.8 The Complete Fraction Class

In this section, we will list a complete definition for the `myutil.Fraction` class. In the final version of the class, we will include improvements to one of the constructors and the `simplify` method. Earlier in the chapter, we presented the fourth constructor as follows:

```
public Fraction(int num, int denom) {
    setNumerator(num);
    setDenominator(denom);
}
```

For this constructor to function properly, we made an assumption that the values for both parameters are nonnegative. Let's remove this assumption and make the necessary modifications to the constructor.

Consider the following two statements:

```
Fraction f1 = new Fraction(-2, 9);
Fraction f2 = new Fraction(2, -9);
```

Both represent the same value, namely, $-\frac{2}{9}$. With the given constructor, f1 will have the values -2 and 9 for its data members numerator and denominator, respectively. And f2 will have the values 2 and -9 for its data members numerator and denominator, respectively. This means that we have two distinct ways to represent the same value. It is always preferable to maintain a consistent representation because multiple representations for the same value would lead to a more complex code for handling different representations correctly. We will improve this constructor so that a negative fraction is always represented by a negative value for numerator and a positive value for denominator.

Now, consider the following two statements:

```
Fraction f3 = new Fraction(2, 9);
Fraction f4 = new Fraction(-2, -9);
```

Both objects represent the same positive fraction $\frac{2}{9}$. Again, to maintain consistent representation, a positive fraction is always represented by positive values for both numerator and denominator.

Finally, consider the following two statements:

```
Fraction f3 = new Fraction(0, 9);
Fraction f4 = new Fraction(0, -5);
```

Both objects represent the numerical value of 0. We will always represent the numerical value of 0 by storing 0 in the data member numerator and 1 in denominator.

Here's the modified constructor:

```
public Fraction(int num, int denom) {
    if (denom < 0) {
        num = -num;
        denom = -denom;
    }
    if (num == 0) {
        denom = 1;
    }
    setNumerator(num);
    setDenominator(denom);
}
```

We will also make a modification to the `simplify` method. The original `simplify` method fails when someone tries to simplify a zero fraction (i.e., a fraction with numerical value of 0). To reduce a fraction to its simplified form, we find the greatest common divisor of its numerator and denominator and divide them by the greatest common divisor. What happens when the numerator is 0? The greatest common divisor of 0 and any other value is 0. So we would end up dividing the numerator and denominator by 0! Here's the new `simplify` method that avoids this problem:

```
public Fraction simplify( ) {
    int num    = getNumerator();
    int denom  = getDenominator();

    int divisor = 1;

    if (num != 0) {
        divisor = gcd(Math.abs(num), denom);
    }

    return new Fraction(num/divisor, denom/divisor);
}
```

```
package myutil;
/**
 * An instance of this class represents a fraction.
 *
 *
 */
public class Fraction {
    /** the numerator of this fraction */
    private int numerator;

    /** the denominator of this fraction */
    private int denominator;

    //-----
    // Constructors
    //-----
    /**
     * Creates a fraction 0/1
     */
    public Fraction( ) {
        this(0, 1);
    }
}
```

Data Members

Constructors

```

/**
 * Creates a fraction number/1
 *
 * @param number the numerator
 */
public Fraction(int number) {
    this(number, 1);
}

/**
 * Creates a copy of frac
 *
 * @param frac a copy of this parameter is created
 */
public Fraction(Fraction frac) {
    this(frac.getNumerator(), frac.getDenominator());
}

/**
 * Creates a fraction num/denom. Create a negative
 * fraction as -num and denom. If negative values
 * are specified for both num and denom, the fraction
 * is converted to a positive. If num is positive and
 * denom is negative, the fraction will be converted to
 * have negative num and positive denom.
 * When the num is zero, denom is set to 1. Zero is
 * always represented as 0/1
 *
 * @param num    the numerator
 * @param denom  the denominator
 */
public Fraction(int num, int denom) {

    if (denom < 0) {
        num    = -num;
        denom = -denom;
    }

    if (num == 0) {
        denom = 1;
    }

    setNumerator(num);
    setDenominator(denom);
}

//-----
// Class Methods
//
//-----

```



```

/**
 * Returns the greatest common divisor of
 * the parameters m and n
 *
 * @param m the first number
 * @param n the second number
 *
 * @return the greatest common divisor of m and n
 */
public static int gcd(int m, int n) {

    int r = n % m;

    while (r !=0) {

        n = m;

        m = r;

        r = n % m;

    }

    return m;

}

/**
 * Returns the smaller of the two parameters f1 and f2
 *
 * @param f1 the first fraction to compare
 * @param f2 the second fraction to compare
 *
 * @return the smaller of the two parameters
 */
public static Fraction min(Fraction f1, Fraction f2) {

    //convert to decimals and then compare
    double f1_dec = f1.decimal();
    double f2_dec = f2.decimal();

    if (f1_dec <= f2_dec) {

        return f1;

    } else {

        return f2;

    }

}

```

gcd

min

```

//-----
// Public Instance Methods
//
//-----

/**
 * Returns the sum of this Fraction
 * and the parameter frac. The sum
 * returned is NOT simplified.
 *
 * @param frac the Fraction to add to this
 *           Fraction
 *
 * @return the sum of this and frac
 */
public Fraction add(Fraction frac) {
    int a, b, c, d;

    Fraction sum;

    a = this.getNumerator();
    b = this.getDenominator();
    c = frac.getNumerator();
    d = frac.getDenominator();

    sum = new Fraction(a*d + b*c, b*d);

    return sum;
}

/**
 * Returns the sum of this Fraction
 * and the int parameter number. The sum
 * returned is NOT simplified.
 *
 * @param number the integer to add to this
 *           Fraction
 *
 * @return the sum of this Fraction and number
 */
public Fraction add(int number) {

    Fraction frac = new Fraction(number, 1);

    Fraction sum = add(frac);

    return sum;
}

```

 add

 add

```
/**
 * Returns the quotient of this Fraction
 * divided by the parameter frac. The quotient
 * returned is NOT simplified.
 *
 * @param frac the divisor of the division
 *
 * @return the quotient of this fraction
 *         divided by frac
 */
```

```
public Fraction divide(Fraction frac) {
    int a, b, c, d;

    Fraction quotient;

    a = this.getNumerator();
    b = this.getDenominator();
    c = frac.getNumerator();
    d = frac.getDenominator();

    quotient = new Fraction(a*d, b*c);

    return quotient;
}
```



```
/**
 * Returns the quotient of this Fraction
 * divided by the int parameter number. The quotient
 * returned is NOT simplified.
 *
 * @param number the divisor
 *
 * @return the quotient of this Fraction divided by number
 */
```

```
public Fraction divide(int number) {

    Fraction frac = new Fraction(number, 1);

    Fraction quotient = divide(frac);

    return quotient;
}
```



```
/**
 * Compares this fraction and the parameter frac for
 * equality. This method compares the two by first
 * reducing them to the simplest form.
 *
 * @param frac the fraction object to compare
 *
 * @return true if this Fraction object and frac are equal
 */
```

```

public boolean equals(Fraction frac) {

    Fraction f1 = simplify(); //simplify itself
    Fraction f2 = frac.simplify(); //simplify frac

    return (f1.getNumerator() == f2.getNumerator() &&
            f1.getDenominator() == f2.getDenominator());
}

/**
 * Returns the denominator of this fraction
 *
 * @return the denominator of this fraction
 */
public int getDenominator( ) {
    return denominator;
}

/**
 * Returns the numerator of this fraction
 *
 * @return the numerator of this fraction
 */
public int getNumerator( ) {
    return numerator;
}

/**
 * Returns the product of this Fraction
 * and the parameter frac. The product
 * returned is NOT simplified.
 *
 * @param frac the multiplier of the multiplication
 *
 * @return the product of this fraction
 *         and the parameter frac
 */
public Fraction multiply(Fraction frac) {
    int a, b, c, d;

    Fraction product;

    a = this.getNumerator();
    b = this.getDenominator();

    c = frac.getNumerator();
    d = frac.getDenominator();

    product = new Fraction(a*c, b*d);

    return product;
}

```

equals

getDenominator

getNumerator

multiply

```
/**
 * Returns the product of this Fraction
 * and the int parameter number. The product
 * returned is NOT simplified.
 *
 * @param number the multiplier
 *
 * @return the product of this Fraction and number
 */
```

```
public Fraction multiply(int number) {
    Fraction frac = new Fraction(number, 1);
    Fraction product = multiply(frac);
    return product;
}
```

multiply

```
/**
 * Sets the denominator of this fraction
 *
 * @param denom the denominator of this fraction
 */
```

```
public void setDenominator(int denom) {
    if (denom == 0) {
        //Fatal error
        System.out.println("Fatal Error");
        System.exit(1);
    }
    denominator = denom;
}
```

setDenominator

```
/**
 * Sets the numerator of this fraction
 *
 * @param num the numerator of this fraction
 */
```

```
public void setNumerator(int num) {
    numerator = num;
}
```

setNumerator

```
/**
 * Returns a new Fraction object that is in
 * the simplest form of this Fraction object. If
 * this Fraction is zero, then a simple copy of
 * it is returned.
 *
 * @return a Fraction object in the simplest form
 *         of this Fraction
 */
```

```

public Fraction simplify( ) {
    int num    = getNumerator();
    int denom  = getDenominator();

    int divisor = 1;

    if (num != 0) {
        divisor = gcd(Math.abs(num), denom);
    }

    return new Fraction(num/divisor, denom/divisor);
}

```



```

/**
 * Returns the difference of this Fraction
 * and the parameter frac. The difference
 * returned is NOT simplified.
 *
 * @param frac the Fraction to subtract from
 *             this Fraction
 *
 * @return the difference of this and frac
 */

```

```

public Fraction subtract(Fraction frac) {
    int a, b, c, d;

    Fraction diff;

    a = this.getNumerator();
    b = this.getDenominator();
    c = frac.getNumerator();
    d = frac.getDenominator();

    diff = new Fraction(a*d - b*c, b*d);

    return diff;
}

```



```

/**
 * Returns the difference of this Fraction
 * and the int parameter number. The difference
 * returned is NOT simplified.
 *
 * @param number the int value to subtract
 *
 * @return the difference of this and number
 */

```

```

public Fraction subtract(int number) {
    Fraction frac = new Fraction(number, 1);
    Fraction difference = subtract(frac);

    return difference;
}

```



```

/**
 * Returns the String representation of this Fraction
 *
 * @return the String representation of this Fraction
 */
public String toString( ) {
    return getNumerator( ) + "/" + getDenominator( );
}

//-----
// Private Methods
//
//-----

/**
 * Returns the decimal equivalent of this fraction
 *
 * @return the decimal equivalent of this fraction
 */
private double decimal( ) {
    //returns the decimal equivalent
    return (double) getNumerator( ) / getDenominator( );
}
}

```

toString

decimal

7.9 Sample Development

Library Overdue Checker

How many library books are lying around in your room waiting to be returned? How much have you accrued in late charges on those overdue books? Let's write a program that computes the total charges for overdue library books. The program allows you to input the title, overdue charge per day, maximum possible charge, and due date for each book you enter. The due date is the only required input. The other three input values are optional, and when they are not provided, preset default values are used by the program. We assume that an upper limit is set for overdue charges, so your charge will not increase beyond this limit. This limit is entered as the maximum possible charge. For example, a library may set \$1.50 as the overdue charge per day and \$30 as the maximum overdue charge for a single overdue book. We enter the overdue charge per day and the maximum overdue charge for every book, because depending on the types of books, they could be different. For example, a charge for books with a 3-day loan period may be much higher than for books with a regular 2-week loan period.

After you enter information for all books, the program displays the entered book data. Then the program will allow you to enter different return dates. For each return date you enter, the program will display the total overdue charges. Being able to enter different

return dates will let you make an informed decision, such as “I’ll wait till tomorrow since it’s raining heavily today and it costs only \$2 more if I return them tomorrow.” (We always encourage you to return library books promptly for the sake of fellow library users.)

A better program will warn you when there’s a looming due date so you won’t end up paying the overdue charges. We will discuss this and other possible extensions at the end of this section. All the possible extensions we will discuss require techniques yet to be studied. The program we develop here is implemented by the techniques we have already mastered and by using one simple helper class.

Problem Statement

Write an application that computes the total charges for the overdue library books. For each library book, the user enters the due date and (optionally) the overdue charge per day, the maximum charge, and the title. If the optional values are not entered, then the preset default values are used. A complete list of book information is displayed when the user finishes entering the input data. The user can enter different return dates to compare the overdue charges.

Overall Plan

As always, we begin our overall plan for the development with the outline of program logic. We first let the user enter the information on all books. After finishing the book data entry, we display them as a list. Then we ask repeatedly for return dates. For each return date entered, we provide the total overdue charge. We express the program flow as having three tasks:

program
tasks

1. Get the information for all books.
2. Display the entered book data.
3. Ask for the return date and display the total charge. Repeat this step until the user quits.

Let’s look at each task and determine objects required for handling the task. The first step sounds simple enough, but it hides the complexity of the whole program. It indicates the need for at least three types of objects. One is to carry out the actual input routines, another is to retain four pieces of information for each book, and yet another is to keep track of multiple books entered by the user. Notice that there’s no limit on the number of books the user can enter, because putting such a limit will reduce the usability of the program. This means we need a class to manage a collection of book information. We have not yet learned how to manage a collection of objects (Chap. 10 covers the topic), so we will use the helper class named **BookTracker**. This class is actually very straightforward, once we learn the relevant topic. The class is written generically and does not contain any application-specific logic.

We will define a class named **LibraryBook** that keeps track of book information. An instance of this class represents a single library book. The **LibraryBook** class is the key “work horse” in this program. A **LibraryBook** object keeps track of four pieces of information and is responsible for computing the overdue charge. Notice that the class is the

7.9 Sample Development—continued

most appropriate place to perform the computation of the overdue charge because it is where all pieces of information necessary to compute the charge are stored.

We will define another class for performing the actual input routines. An instance of this class will input the data, create a **LibraryBook** object with the input data, and add this object to a **BookTracker**. As it uses other objects, it will be the main controller of the program. We will name the class **OverdueChecker**. We will define it as an instantiable main class. For this program, we will use console input. It is a straightforward exercise to modify the **OverdueChecker** class to handle input by using **JOptionPane** or other types of GUI.

Now let's study the second task of displaying the entered book data. To be consistent with the console input, we will use console output. An **OverdueChecker** will handle the output, but the data to display come from a **BookTracker**, as it is the one maintaining the collection of **LibraryBook** objects. The **BookTracker** class has one method called **getBookList**. This method returns the book list as a single **String** value. The **OverdueChecker** displays the returned string on the standard output window. Notice that the **BookTracker** class is not programmed to do the output directly, because doing so will reduce its usability. By returning the book list as a **String** datum, the client of the **BookTracker** class retains the option of using either console output or GUI. This helps to keep the flexibility and increases the usability of a class.

For the last task, an **OverdueChecker** interacts with the user to get the return dates. For each return date entered, it asks **BookTracker** for the total charge and displays the returned value. The **BookTracker** in turn asks individual **LibraryBook** objects for their charges by calling the **computeCharge** method and computes the sum. This is the reason why we must include the method named **computeCharge** in the **LibraryBook** class that computes the overdue charge for a single book. We will discuss the details of this and other requirements in defining the **LibraryBook** class shortly.

Here's our working design document:

program
classes

Design Document: Library OverdueChecker	
Class	Purpose
OverdueChecker	The top-level control object that manages other objects in the program. This is an instantiable main class, as explained in Section 4.10.
BookTracker	The predefined helper class that keeps track of library books.
LibraryBook	An instance of this class represents a single library book. A library book for this program has four properties—title, charge per day, maximum charge, and due date. It is also responsible for computing the overdue charges.
Scanner	The standard class for handling input routines.

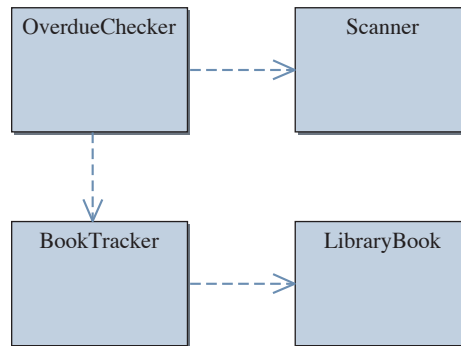

Figure 7.11 The program diagram for the **OverdueChecker** program. We will implement the **OverdueChecker** and **LibraryBook** classes. The **Scanner** class is the standard class for console input, and the **BookTracker** class is the helper class provided for this program.

Figure 7.11 is the program diagram for this program.

We will implement this program in the following five major steps:

development
steps

1. Define the basic **LibraryBook** class. Use a test main class to confirm the implementation of the **LibraryBook** class.
2. Explore the given **BookTracker** class and integrate it with the **LibraryBook** class. Modify or extend the **LibraryBook** class as necessary.
3. Define the top-level **OverdueChecker** class. Implement the complete input routines. Modify or extend the **LibraryBook** class as necessary.
4. Complete the **LibraryBook** class by fully implementing the overdue charge computation.
5. Finalize the program by tying up loose ends.

Again, the development strategy we indicate here is one of the possible alternatives. We could start from the skeleton main controller class **OverdueChecker**, as we normally did in the previous sample development examples. For this program, however, we start with the **LibraryBook** class because of its importance in the program. We want to start from the most important workhorse class. Also, before we implement any elaborate input and output routines, we need to know how the **BookTracker** class works, and to explore this helper class fully, we need the **LibraryBook** class.

Step 1 Development: The Basic **LibraryBook** class

step 1
design

We begin the development with the basic **LibraryBook** class. The main purpose in step 1 is to start with the main workhorse class to establish the foundation for the development. Since this class is used by the **BookTracker** class, we need to find out the compatibility requirements so we won't define any methods that will violate the compatibility. There

7.9 Sample Development—continued

are two methods used by the **BookTracker** class, so we need to define them in the **LibraryBook** class. Here are the two required methods and their descriptions:

Required Methods of <code>LibraryBook</code>
<pre>public String toString() Returns the String representation of itself. This string is used by the BookTracker class to generate a complete book list.</pre>
<pre>public double computeCharge(GregorianCalendar returnDate) Computes and returns the overdue charge for this book, given the return date.</pre>

The key design task for this step is to identify the data members for storing relevant information and to define their accessors and mutators as appropriate. Also, we will design multiple constructors so an instance of this class can be created in a flexible manner.

We define data members for the four pieces of required information for each book as follows:

```
private GregorianCalendar dueDate;
private String title;
private double chargePerDay;
private double maximumCharge;
```

For each of these data members, we will define the corresponding accessors and mutators.

We define four constructors. Because the due date is something that must be assigned when a new **LibraryBook** is created, every constructor requires the due date as its argument. When other optional values are not passed to the constructor, then preset default values are assigned. We define the multiple constructors using the technique we learned in this chapter. The signatures for these constructors are as follows:

```
public LibraryBook(GregorianCalendar dueDate)
public LibraryBook(GregorianCalendar dueDate,
                  double chargePerDay)
public LibraryBook(GregorianCalendar dueDate,
                  double chargePerDay,
                  double maximumCharge)
public LibraryBook(GregorianCalendar dueDate,
                  double chargePerDay,
                  double maximumCharge,
                  String title)
```

We won't be using the **BookTracker** class in this step, so we do not have to define the two required methods yet. However, we can use the **toString** method now to verify the correct operations of constructors and other methods, so we define it now. We use the formatting techniques learned in Section 6.8 to format the string we return from **toString**. Here's how we define the **toString** method:

```
public String toString( ) {
    return String.format(
        "%-30s    $%5.2f    $%7.2f    %4$tm/%4$td/%4$ty",
        getTitle(), getChargePerDay(),
        getMaxCharge(), dueDate.getTime());
}
```

A sample string returned from the method will be formatted in the following manner:

```
Introduction to OOP with Java    $ 0.75    $ 50.00    07/10/06
```

Alternatively, we can format the string by using the **SimpleDateFormat** and **DecimalFormat** classes.

```
public String toString( ) {
    String tab = "\t";
    SimpleDateFormat sdf
        = new SimpleDateFormat("MM/dd/yy");
    DecimalFormat df = new DecimalFormat("0.00");

    return getTitle() + tab + "$ " +
        df.format(getChargePerDay()) + tab + "$ " +
        df.format(getMaxCharge()) + tab +
        sdf.format(dueDate.getTime());
}
```

step 1 code

We are now ready to implement the class. Here's the step 1 code (minus javadoc and most other comments):

```
/*
Chapter 7 Library Overdue Checker

Step 1 LibraryBook class

File: LibraryBook.java
*/
```

7.9 Sample Development—*continued*

```
import java.util.*;

class LibraryBook {

    private static final double CHARGE_PER_DAY = 0.50;
    private static final double MAX_CHARGE = 50.00;
    private static final String DEFAULT_TITLE = "Title unknown";

    private GregorianCalendar dueDate;
    private String title;
    private double chargePerDay;
    private double maximumCharge;

    public LibraryBook(GregorianCalendar dueDate) {
        this(dueDate, CHARGE_PER_DAY);
    }

    public LibraryBook(GregorianCalendar dueDate,
        double chargePerDay) {
        this(dueDate, chargePerDay, MAX_CHARGE);
    }

    public LibraryBook(GregorianCalendar dueDate,
        double chargePerDay,
        double maximumCharge) {
        this(dueDate, chargePerDay,
            maximumCharge, DEFAULT_TITLE);
    }

    public LibraryBook(GregorianCalendar dueDate,
        double chargePerDay,
        double maximumCharge,
        String title) {

        setDueDate(dueDate);
        setChargePerDay(chargePerDay);
        setMaximumCharge(maximumCharge);
        setTitle(title);
    }

    public double getChargePerDay( ) {
        return chargePerDay;
    }
}
```

```

public GregorianCalendar getDueDate( ) {
    return dueDate;
}

public double getMaxCharge( ) {
    return maximumCharge;
}

public String getTitle( ) {
    return title;
}

public void setChargePerDay(double charge) {
    chargePerDay = charge;
}

public void setDueDate(GregorianCalendar date) {
    dueDate = date;
}

public void setMaximumCharge(double charge) {
    maximumCharge = charge;
}

public void setTitle(String title) {
    this.title = title;
}

public String toString( ) {
    return String.format(
        "%-30s $%5.2f $%7.2f %4$tm/%4$td/%4$ty",
        getTitle(), getChargePerDay(),
        getMaxCharge(), dueDate.getTime());
}
}

```

step 1 test

The purpose of step 1 testing is to verify we can create **LibraryBook** objects using different constructors. In addition, we check that the other methods are working correctly, especially the **toString** method. Here's one possible test main class:

```

/*
  Introduction to OOP with Java 4th ed., McGraw-Hill

  File: Step1/Step1Main.java
*/

```

7.9 Sample Development—continued

```

import java.util.*;

class Step1Main {

    public static void main( String[] args ) {

        //Create three LibraryBook objects and output them
        GregorianCalendar dueDate;
        LibraryBook book1, book2, book3, book4;

        dueDate = new GregorianCalendar(2008, Calendar.MARCH, 14);
        book1 = new LibraryBook(dueDate);

        dueDate = new GregorianCalendar(2008, Calendar.FEBRUARY, 13);
        book2 = new LibraryBook(dueDate, 0.75);
        book2.setTitle("Introduction to oop with Java");

        dueDate = new GregorianCalendar(2008, Calendar.JANUARY, 12);
        book3 = new LibraryBook(dueDate, 1.00, 100.00);
        book3.setTitle("Java for Smarties");

        dueDate = new GregorianCalendar(2008, Calendar.JANUARY, 1);
        book4 = new LibraryBook(dueDate, 1.50, 230.00,
                                "Me and My Java");

        System.out.println(book1.toString());
        System.out.println(book2.toString());
        System.out.println(book3.toString());
        System.out.println(book4.toString());
    }
}

```

Running this program will produce the following output on the standard output window:

Title unknown	\$ 0.50	\$ 50.00	03/14/08
Introduction to OOP with Java	\$ 0.75	\$ 50.00	02/13/08
Java for Smarties	\$ 1.00	\$ 100.00	01/12/08
Me and My Java	\$ 1.50	\$ 230.00	01/01/08

step 2
design

Step 2 Development: Integrate the **BookTracker** Class into the Program

In the second development step, we will bring in the helper **BookTracker** class into the program. Our main concern in this step is to understand how to interact with a **BookTracker** object correctly and adjust the **LibraryBook** class, as necessary, to make it compatible with the **BookTracker** class.

The **BookTracker** class is actually a fairly straightforward class. You are encouraged to view the source file of the class. To understand the class fully, you need to learn about an **ArrayList**, a topic covered in Chapter 10. But even without this knowledge, you should be able to understand the majority of the code when you view the source file. We will discuss the implementation of the **BookTracker** class in Chapter 10. Here's the class description:

BookTracker
An instance of this class maintains a list of LibraryBook objects.
<code>public BookTracker()</code> Creates a new instance of the class.
<code>public void add(LibraryBook book)</code> Adds book to the book list it maintains.
<code>public double getCharge()</code> Returns the total overdue charge for the books in the list. Uses today as the return date.
<code>public double getCharge(GregorianCalendar returnDate)</code> Returns the total overdue charge for the books in the list. The parameter is the date the book is to be returned.
<code>public String getList()</code> Returns information on all books in the list as a single string.

As stated in step 1, the **BookTracker** class requires two specific methods in the **LibraryBook** class. We already defined the **toString** method. Since we will be implementing the full **computeCharge** method in step 4, we define a stub method for this step as

```
public double computeCharge( GregorianCalendar returnDate){
    return 1.00; //Stub method for Step 2
}
```

To check our understanding on how to interact with the **BookTracker** class, we will write a test main class. From this main class, we will create and add multiple book objects to the book tracker and experiment with the **getList** and **getCharge** methods.

step 2 code

The only change we make to the **LibraryBook** class is the addition of the stub **computeCharge** method, so the **BookTracker** class can be integrated with it. To test

7.9 Sample Development—continued

the **BookTracker** class, we define a test main class that checks the cases when the book list is empty and has 20 books. Here's the test main class:

```

/*
   Introduction to OOP with Java 4th ed., McGraw-Hill
   File: Step2/Step2Main.java
*/
import java.util.*;
class Step2Main {
    public static void main( String[] args ) {
        //Create 20 LibraryBook objects
        BookTracker bookTracker = new BookTracker();
        GregorianCalendar dueDate, returnDate;
        LibraryBook book;
        returnDate = new GregorianCalendar(2008, Calendar.MARCH, 15);
        //Check the error condition
        System.out.println("Error: No books added. Return code - " +
            bookTracker.getCharge(returnDate));
        System.out.println("Output for empty book list:\n" +
            bookTracker.getList( ));
        //Add 20 books
        System.out.println("\nAdding 20 books...\n");
        for (int i = 0; i < 20; i++) {
            dueDate = new GregorianCalendar(2008, Calendar.MARCH, i+1);
            book = new LibraryBook(dueDate);
            book.setTitle("Book Number " + (i+1));
            bookTracker.add(book);
        }
        System.out.println("Total Charge: $"
            + bookTracker.getCharge(returnDate));
        System.out.println("\n");
        System.out.println("List: \n" + bookTracker.getList());
    }
}

```

step 2 test

We run the test main class and verify that we get the expected results. We will try other variations to increase our confidence before continuing to the next step.

Step 3 Development: Define the OverdueChecker Class

step 3 design

After the working **LibraryBook** and **BookTracker** classes, we are now ready to start implementing the top-level controller class. Besides managing a single **BookTracker** object and multiple **LibraryBook** objects, an **OverdueChecker** object's main responsibility is the handling of input and output routines. As dictated in the problem statement, we have to first input information on books and then repeatedly ask the user for return dates. Expressing this logic in pseudocode, we have

```
GregorianCalendar returnDate;

String reply, table;
double totalCharge;

inputBooks(); //read in all book information

table = bookTracker.getList();
System.out.println(table);

//try different return dates
do {

    returnDate = read return date ;
    totalCharge = bookTracker.getCharge(returnDate);
    displayTotalCharge(totalCharge);
    reply = prompt the user to continue or not;
} while ( reply is yes );
```

The body of the **inputBooks** method will include a loop that reads information for one book on each repetition. The method body can be expressed thus:

```
while (isContinue()) {

    title          = readString("Title          : ");
    chargePerDay   = readDouble("Charge per day: ");
    maxCharge      = readDouble("Maximum charge: ");
    dueDate        = readDate ("Due Date      : ");

    book = createBook(title, chargePerDay,
                      maxCharge, dueDate);

    bookTracker.add(book);
}
```

Notice that there are three types of input data, and we define a method for each type, namely, **readDouble**, **readDate**, and **readString**. These methods read input from a scanner (console input) after prompting the user.

7.9 Sample Development—continued

Code to handle the input of **String** and **double** values is straightforward, but the one to handle the input of the date requires some thinking. We need to decide in which format the user can enter the date. For instance, should we prompt for the year, month, and day individually? This may be acceptable if you enter the date once. When you have to input date information many times, this input routine gets tedious. For this application, we will require the user to enter the date correctly as a single string value in the **MM/dd/yyyy** format. Given a string value in this format, we use a sequence of substring methods to break it down into three pieces—month, day, and year. This operation is similar to the one we used in the Chapter 2 sample application. Then we use the **Integer.parseInt** method, introduced in Chapter 3, to convert them to **int** values. From these three **int** values, we finally create and return a **GregorianCalendar** object that represents the entered date.

After the four values are entered, a new book is created via the **createBook** method. This method handles the situation when the input value is empty. For example, the user may press only the Enter key if she wants default values for the single-day charge and maximum possible charge.

step 3 code

The other methods are straightforward, so we'll refer you to the complete class listing without further explanation. Here's the instantiable main class **OverdueChecker**:

```

/*
Chapter 7 Library Overdue Checker

Step 3 Implement the Main Controller
*/
import java.util.*;

class OverdueChecker {

    private static enum Response {YES, NO}

    private static final String DATE_SEPARATOR = "/";

    private Scanner scanner;

    private BookTracker bookTracker;

    //-----
    // Constructors
    //-----

    public OverdueChecker() {

        scanner = new Scanner(System.in);
    }

```

```

        scanner.useDelimiter(System.getProperty("line.separator"));
        bookTracker = new BookTracker();
    }

//-----
//    Main Method
//-----

    public static void main(String[] args) {
        OverdueChecker checker = new OverdueChecker();
        checker.start();
    }

//-----
//    Public Methods
//-----

    public void start( ) {
        GregorianCalendar returnDate;

        String    table;
        double    charge;
        Response response;

        inputBooks();

        table = bookTracker.getList();
        System.out.println(table);

        System.out.println("\nNow check the over due charges...\n");
        //try different return dates
        do {
            //read return date
            returnDate = readDate("\nReturn Date: ");
            charge = bookTracker.getCharge(returnDate);
            displayTotalCharge(charge);
            response = prompt("\nRun Again (yes/no)? ");
        } while (response == Response.YES);
        System.out.println(
            "\n\nThank you for using Library Overdue Checker");
    }

//-----
//    Private Methods
//-----

```

7.9 Sample Development—continued

```

private LibraryBook createBook(String title,
                               double chargePerDay,
                               double maxCharge,
                               GregorianCalendar dueDate) {
    if (dueDate == null) {
        dueDate = new GregorianCalendar(); //set today as due date
    }

    LibraryBook book = new LibraryBook(dueDate);

    if (title.length() > 0) {
        book.setTitle(title);
    }

    if (chargePerDay > 0.0) {
        book.setChargePerDay(chargePerDay);
    }

    if (maxCharge > 0.0) {
        book.setMaximumCharge(maxCharge);
    }

    return book;
}

private void display(String text) {
    System.out.print(text);
}

private void displayTotalCharge(double charge) {
    System.out.format("\nTOTAL CHARGE:\t $%8.2f", charge);
}

private void inputBooks( ) {
    double chargePerDay, maxCharge;
    String title;

    GregorianCalendar dueDate;
    LibraryBook book;

    //Keeps on reading input from a console
    //until stopped by the end user

    while (isContinue()) {
        System.out.println("\n");

        title = readString("Title : ");
        chargePerDay = readDouble("Charge per day: ");
    }
}

```

```

        maxCharge    = readDouble("Maximum charge: ");
        dueDate      = readDate  ("Due Date      : ");

        book = createBook(title, chargePerDay,
                           maxCharge, dueDate);

        bookTracker.add(book);
    }
}

private boolean isContinue( ) {
    Response response = prompt("\nMore books to enter (y/n)?");
    return (response == Response.YES);
}

private Response prompt(String question) {
    String input;
    Response response = Response.NO;
    System.out.print(question + " (Yes - y; No - n): ");
    input = scanner.next();
    if (input.equals("Y") || input.equals("y")) {
        response = Response.YES;
    }
    return response;
}

private double readDouble(String prompt) {
    display(prompt);
    return scanner.nextDouble();
}

private GregorianCalendar readDate( String prompt) {
    GregorianCalendar cal;

    String yearStr, monthStr, dayStr, line;
    int    sep1, sep2;
    display(prompt);
    line = scanner.next();

```

7.9 Sample Development—continued

```

    if (line.length() == 0) {
        cal = null;
    } else {

        sep1 = line.indexOf (DATE_SEPARATOR);
        sep2 = line.lastIndexOf (DATE_SEPARATOR);

        monthStr = line.substring (0, sep1);
        dayStr    = line.substring (sep1 + 1, sep2);
        yearStr   = line.substring (sep2 + 1, line.length());

        cal = new GregorianCalendar (Integer.parseInt (yearStr),
                                    Integer.parseInt (monthStr)-1,
                                    Integer.parseInt (dayStr));
    }

    return cal;
}

private String readString (String prompt) {
    display (prompt);

    return scanner.next ();
}
}

```

step 3 test

Now we run the program multiple times, trying different input types and values. We also confirm that all control loops are implemented and working correctly. At this point, the code to compute the overdue charge is still a stub, so we will always get the same overdue charge for the same number of books. After we verify that everything is working as expected, we proceed to the next step.

Step 4 Development: Compute the Overdue Chargestep 4
design

In step 4, we complete the stub method that computes the overdue charge in the **LibraryBook** class. We have two **GregorianCalendar** objects for the due date and the return date. We first need to find out the number of days between the two. We then multiply this number by the amount of charge per day to derive the total overdue charge. If this amount is more than the maximum possible charge, then the total charge is reset to this maximum value. Also, we need to check for the situation in which the return date has not passed the due date. The logic of this process is a simple computation once we find out the number of days between the two dates. So, how can we find it?

design
alternative 1

Reviewing the **GregorianCalendar** class, we see the **get** method can be used to retrieve different pieces of date information, such as year, month, and day. Using the method, we can get the month, day, and year information for two dates and compare these values. It may sound easy, but things can get tricky very quickly. Complexity arises from the facts that not every month has the same number of days and that the number of days for February can vary from year to year. This approach is doable, but not recommended.

design al-
ternative 2

When we explore the class further, we notice there's another method, namely **getTime**, that returns a **Date** object. In Chapter 6, we used this **Date** class to compute the execution time of a loop by finding the difference between the start and end times. We can apply the same technique here. But instead of using the **getTime** method, we can actually use the **getTimeInMillis** method and bypass the **Date** class altogether. The **getTimeInMillis** method returns the time elapsed since the epoch to the date in milliseconds. By subtracting this since-the-epoch milliseconds value of the due date from the same of the return date, we can find the difference between the two. If the difference is negative, then it's not past due, so there's no charge. If the difference is positive, then we convert the milliseconds to the equivalent number of days and multiply it by the per-day charge to compute the total charge. Here's a simple way to do the conversion:

```
private static final double MILLISEC_TO_DAY
    = 1.0 / 1000 / 60 / 60 / 24;
...
dayCnt = millisec * MILLISEC_TO_DAY;
```

step 4 code

We will adopt the second approach. Here's the final **computeCharge** method of the **LibraryBook** class:

```
public double computeCharge(GregorianCalendar returnDate){
    double charge = 0.0;
    long dueTime = dueDate.getTimeInMillis();
    long returnTime = returnDate.getTimeInMillis();
    long diff = returnTime - dueTime;
    if (diff > 0) {
        charge = chargePerDay * diff * MILLISEC_TO_DAY;
        if (charge > maximumCharge) {
            charge = maximumCharge;
        }
    }
    return charge;
}
```

step 4 test

We run the program multiple times again, possibly using the same set of input data. We enter different input variations to try out all possible cases for the **computeCharge**

7.9 Sample Development—*continued*

method. Try cases such as the return date and due date are the same, the return date occurs before the due date, the charge is beyond the maximum, and so forth. After we verify the program, we move on to the next step.

Step 5 Development: Tying Up the Loose Ends and Future Extensions

program
review

As always, we will perform a critical review of the program, looking for any unfinished method, inconsistency or error in the methods, unclear or missing comments, and so forth. We should also not forget to improve the program for cleaner code and better readability. This is especially true for the input routines. Are all the possible cases handled? Are the input routines easy to use? Will it be better if we allow different formats for entering the date information?

possible
extensions

We stated at the beginning of this section that it would be a better program if it warned the user, say, by popping a warning window or ringing an alarm, when the due date was approaching. Using this extended program, we enter the book data at the time we check out the book from the library. The program will store the entered information in a file, so we don't have to reenter the same data whenever we want to find out the total overdue charge. We can execute the program daily and be warned about the looming due dates. We can still run the program to find out the charges for the overdue books. Techniques necessary to implement such an extended program are covered in the later chapters of this book.

S u m m a r y

- When a method returns an object, it is actually returning a reference to this object.
- The reserved word `this` is used to refer to a receiving object of a message from within this object's method.
- A class may include multiple methods with the same name as long as their signatures are different. The signature of a method refers to the name of the method and the number and data types of its parameters. They are called overloaded methods.
- A class may include multiple constructors as long as their signatures are different. They are called overloaded constructors.
- A constructor can call another constructor of the same class using the reserved word `this`.
- Class variables and class methods are declared by using the reserved word `static`.
- Class methods can access only the class variables and the class constants.

- Instance methods can access all types of data members (i.e., both class and instance components).
- Arguments are passed to the methods by using the call-by-value scheme in which the value of an argument is passed. The value is the actual data in the case of a primitive data type and a reference to an object in the case of a reference data type.
- Programmer-defined classes can be grouped into a programmer-defined package.
- The javadoc comment is the third style of comments used in Java. From the javadoc comments in a class, a tool can generate its documentation in the HTML format.

Key Concepts

returning objects from methods
self referencing pointer (this)
overloaded methods
method signatures
multiple constructors

copy constructors
static initializers
call-by-value scheme
programmer-defined packages
javadoc comments

Chapter 7 Exercises

Review Exercises

1. Consider the following classes.

```
class Cat {
    private String name;
    private Breed breed;
    private double weight;

    public Cat(String name, Breed breed, double weight){
        this.name = name;
        this.breed = breed;
        this.weight = weight;
    }

    public Breed getBreed() {
        return breed;
    }

    public double getWeight() {
        return weight;
    }

    //other accessors and mutators
    . . .
}
```

```

class Breed {
    private String name;
    private double averageWgt; //in lbs.

    public Breed(String name, double averageWgt){
        this.name = name;
        this.averageWgt = averageWgt;
    }

    public double getWeight( ) {
        return averageWgt;
    }

    //other accessors and mutators
    . . .
}

```

Identify the invalid statements in the following main class. For each invalid statement, state why it is invalid.

```

class Q1Main {
    public static void main(String[] args ) {
        Breed persian = new Breed("Persian", 10.0);
        Cat chacha = new Cat("Cha Cha", persian, 12.0);
        Cat bombom = new Cat("Bom Bom", "mix", 10.0);
        Cat puffpuff = new Cat("Puff Puff", chacha, 9.0);
        double diff = chacha.getWeight()
            - persian.getWeight();
        System.out.println(
            puffpuff.getBreed().getWeight());
    }
}

```

2. Given the Cat and Breed classes from Exercise 1, what will be the output from the following code?

```

class Q2Main {
    public static void main(String[] args) {
        Cat myCat = new Cat("winky",
            new Breed("mix", 10.5), 9.5);
        System.out.println(myCat.getWeight());
        System.out.println(myCat.getBreed().getWeight());
    }
}

```

3. Given the Fraction class from Section 7.8, draw the state-of-memory diagram at the point immediately after the last statement is executed.

```
Fraction f1, f2, f3;

f1 = new Fraction(3, 8);
f2 = new Fraction(2, 3);
f3 = f1.add(f2);
```

4. Consider the following class.

```
class Dog {
    . . .

    private double weight;
    . . .

    public boolean isBiggerThan(Dog buddy) {
        return this.getWeight() > buddy.getWeight();
    }

    public double getWeight() {
        return weight;
    }
    . . .
}
```

For each of the following code fragments, complete the state-of-memory diagram by filling in the arrows for this and buddy.

- a. `Dog tuffy = new Dog(...);`
`Dog puffy = new Dog(...);`
`puffy.isBiggerThan(tuffy);`

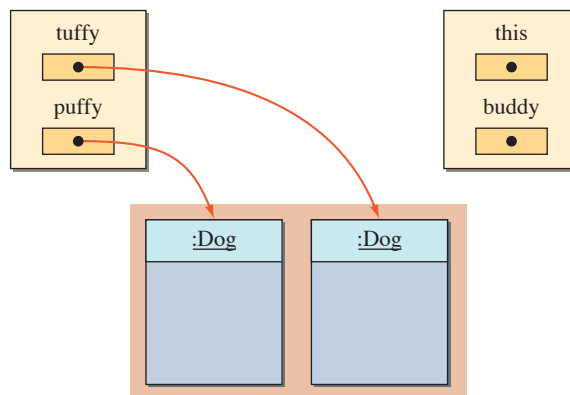

```
b. Dog tuffy = new Dog(...);
   Dog puffy = new Dog(...);
   tuffy.isBiggerThan(puffy);
```

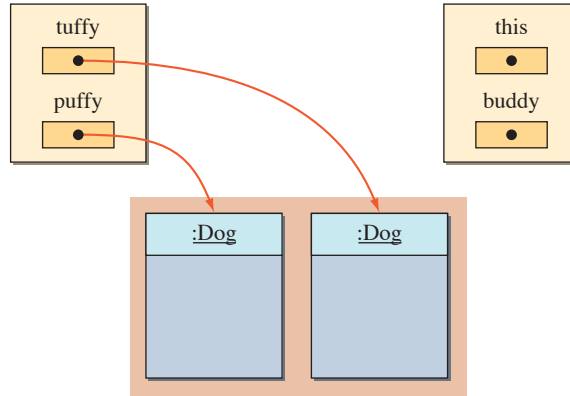

5. Complete the following constructor.

```
class Student {
    private String name;
    private int age;
    private Address address;

    public Student(String name, int age, Address address){
        //assign passed values to the data members
    }
}
```

6. Which of the following groups of overloaded constructors are valid?

- a. `public Cat(int age) { ... }`
`public Cat(double wgt) { ... }`
- b. `public Dog(String name, double weight) { ... }`
`public Dog(String name, double height) { ... }`
- c. `public Dog(String name, double weight) { ... }`
`public Dog(double weight, String name) { ... }`
- d. `public Cat(String name) { ... }`
`public Cat(String name, double weight) { ... }`
`public Cat(double weight) { ... }`

7. Which of the following groups of overloaded methods are valid?

- a. `public void compute(int num) { ... }`
`public int compute(double num) { ... }`
- b. `public void move(double length) { ... }`
`public void move() { ... }`

```

c. public int  adjust(double amount) { ... }
   public void adjust(double amount, double charge) { ... }

d. public void doWork( ) { ... }
   public void doWork(String name) { ... }
   public int  doWork(double num) { ... }

```

8. Complete the first four constructors of the following class. Each of the four constructors calls the fifth one by using the reserved word `this`.

```

class Cat {
    private static final String DEFAULT_NAME = "No name";
    private static final int    DEFAULT_HGT  = 6;
    private static final double DEFAULT_WGT  = 10.0;

    private String name;
    private int    height;
    private double weight;

    public Cat( ) {
        //assign defaults to all data members
    }

    public Cat(String name) {
        //assign the passed name to the data member
        //use defaults for height and weight
    }

    public Cat(String name, int height) {
        //assign passed values to name and height
        //use default for weight
    }

    public Cat(String name, double weight) {
        //assign passed values to name and weight
        //use default for height
    }

    public Cat(String name, int height, double weight){
        this.name = name;
        this.height = height;
        this.weight = weight;
    }

    ...
}

```

9. Define a class method (static) named `compare` to the `Fraction` class. The `compare` method accepts two `Fraction` objects `f1` and `f2`. The method returns

```

-1    if f1 is less than f2
 0    if f1 is equal to f2
+1    if f1 is greater than f2

```

10. Rewrite the compare method from Exercise 9 by changing it to an instance method. This method accepts a Fraction object and compares it to the receiving object. The method is declared as follows:

```
public int compare(Fraction frac) {
    //compare the Fraction objects this and frac
    //return the result of comparison
}
```

11. Discuss the pros and cons of the compare methods from Exercise 8 and Exercise 9.
12. Consider the following class.

```
class Modifier {
    public static change(int x, int y){
        x = x - 10;
        y = y + 10;
    }
}
```

What will be an output from the following code?

```
int x = 40;
int y = 20;

Modifier.change(x,y);

System.out.println("x = " + x);
System.out.println("y = " + y);
```

Level 1 Programming Exercises ★

13. Modify the following class to make it a part of the package named myutil. In addition to adjusting the source file, what are the steps you need to take so that the class becomes usable/accessible from other classes that are outside of this myutil package?

```
class Person {
    private String name;
    public Person( ) {
        name = "Unknown";
    }
    public String getName() {
        return name;
    }
    public void setName(String name) {
        this.name = name;
    }
}
```

14. Write a program that tests the `Person` class defined in Exercise 13. Place this test program outside of the `myutil` package and make sure you can call the constructor and the methods of the `Person` class correctly.

Level 2 Programming Exercises ★ ★

15. Design a class that keeps track of a student's food purchases at the campus cafeteria. A meal card is assigned to an individual student. When a meal card is first issued, the balance is set to the number of points. If the student does not specify the number of points, then the initial balance is set to 100 points. Points assigned to each food item are a whole number. A student can purchase additional points at any time during a semester. Every time food items are bought, points are deducted from the balance. If the balance becomes negative, the purchase of food items is not allowed. There is obviously more than one way to implement the `MealCard` class. Any design that supports the key functionalities is acceptable. Put this class in the `myutil` package.
16. Write a program that tests the meal card class defined in Exercise 15. Define this test program outside the `myutil` package. Create one or two meal card objects in the test program and verify that all methods defined in the meal card class operate correctly.

Development Exercises

For the following exercises, use the incremental development methodology to implement the program. For each exercise, identify the program tasks, create a design document with class descriptions, and draw the program diagram. Map out the development steps at the start. Present any design alternatives and justify your selection. Be sure to perform adequate testing at the end of each development step.

17. Write an application that plays the game of Fermi. Generate three distinct random digits between 0 and 9. These digits are assigned to positions 1, 2, and 3. The goal of the game is for the player to guess the digits in three positions correctly in the least number of tries. For each guess, the player provides three digits for positions 1, 2, and 3. The program replies with a hint consisting of Fermi, Pico, or Nano. If the digit guessed for a given position is correct, then the reply is Fermi. If the digit guessed for a given position is in a different position, the reply is Pico. If the digit guessed for a given position does not match any of the three digits, then the reply is Nano. Here are sample replies for the three secret digits 6, 5, and 8 at positions 1, 2, and 3, respectively:

Guess	Hint	Explanation
1 2 5	Nano Nano Pico	The value 5 matches but at the wrong position.
8 5 3	Pico Fermi Nano	The value 5 matches at the correct position. The value 8 matches but at the wrong position.
5 8 6	Pico Pico Pico	All match at the wrong positions.

Notice that if the hints like the above are given, the player can tell which number did not match. For example, given the hint for the second guess, we can tell that 3 is not one of the secret numbers. To avoid this, provide hints in a random order or in alphabetical order (e.g., it will be Fermi Nano Pico instead of Pico Fermi Nano for the second reply).

Play games repeatedly until the player wants to quit. After each game, display the number of guesses made.

Use javadoc comments to document the classes you design for this application.

18. Write an application that teaches children fraction arithmetic. For each training session, randomly generate 10 questions involving addition, subtraction, division, and multiplication of two fractions. At the beginning of each session, the user has the option of specifying the time limit for answering the questions. If the time limit is not specified, then use 30 s as a default time limit. After you pose a question, wait until the user answers the question. Award points based on the following rules:

Answer	Time	Points
Correct	Under limit	10
Correct	Over limit	6
Wrong	Under limit	3
Wrong	Over limit	0

After one session is over, use the console output to display the grade distribution and the total points in the following manner:

```

                Under          Over
                Time Limit    Time Limit
Correct Answers      4              3
Wrong Answers        2              1
TOTAL POINTS: 64 (40 + 18 + 6 + 0)

```

After one session is over, give the user the option to play another session.

8

Exceptions and Assertions

O b j e c t i v e s

After you have read and studied this chapter, you should be able to

- Improve the reliability of code by incorporating exception-handling and assertion mechanisms.
- Write methods that propagate exceptions.
- Implement the **try-catch** blocks for catching and handling the thrown exceptions.
- Write programmer-defined exception classes.
- Distinguish between the checked and unchecked, or runtime, exceptions.
- Use assertions in methods to increase the chance of detecting bugs during the development.

Introduction



W

hen someone says his or her program is reliable, what do we expect from the program? The majority of people would probably reply correctness as the most important criterion in determining the reliability of a program. When a program is claimed to be reliable, we certainly expect the program will produce correct results for all valid input. It is hardly a reliable program if it produces correct results only for some input values. As we all know by now, writing a correct program is easier said than done. If we are not diligent and careful enough, we can easily introduce bugs in our programs. And often we fail to eradicate them. A mechanism called an *assertion* can be used to improve the likelihood of catching logical errors during the development. We will introduce assertions in this chapter and show how to use them effectively in our programs.

assertion

Program correctness guarantees correct results for all valid input. But what happens when the input is invalid? Another important criterion of program reliability is the robustness, which measures how well the program runs under various conditions. If a program crashes too easily when a wrong type of argument is passed to a method or an invalid input value is entered, we cannot say the program is very robust. A mechanism called *exception handling* can be used to improve the program's robustness. In this chapter, we will describe how to code this exception-handling mechanism in Java to improve the program's robustness.

exception handling

8.1 Catching Exceptions

In Chapters 5 and 6 we presented two types of control flows: selection control and repetition control. Using these control structures, we alter the default sequential flow of control. We use a selection control to select and execute one block of code out of many choices, and we use a repetition control to execute a block of code repeatedly until certain conditions are met. The exception-handling mechanism can be viewed as another form of control structure. An *exception* represents an error condition that can occur during the normal course of program execution. When an exception occurs, the normal sequence of flow is terminated and the exception-handling routine is executed. When an exception occurs, we say an exception is *thrown*. When the matching exception-handling code is executed, we say the thrown exception is *caught*. By using exception-handling routines judiciously in our code, we can increase its robustness. In this section, we will show how the thrown exceptions can be caught and processed.

exception

We have been dealing with exceptions all along. For example, consider this code:

```
Scanner scanner = new Scanner(System.in);

System.out.print("Enter integer: ");
int number = scanner.nextInt();
```

What would happen if we entered, say, abc123, an input value that is not an int? We would get an error message like this:

```
Exception in thread "main" java.util.InputMismatchException
    at java.util.Scanner.throwFor(Scanner.java:819)
    at java.util.Scanner.next(Scanner.java:1431)
    at java.util.Scanner.nextInt(Scanner.java:2040)
    at java.util.Scanner.nextInt(Scanner.java:2000)
    at Ch8Sample1.main(Ch8Sample1.java:35)
```

This error message indicates the system has caught an exception called the `InputMismatchException`, an error that occurs when we try to convert a string that cannot be converted to a numerical value. Up until now, we have let the system handle the thrown exceptions. However, when we let the system handle the exceptions, a single thrown exception most likely will result in erroneous results or a program termination. Instead of depending on the system for exception handling, we can increase the program's reliability and robustness if we catch the exceptions ourselves by including error recovery routines in our program.

Let's begin with a short program to illustrate the exception-handling mechanism. We will define a service class that supports a method to input a person's age. This class is mainly for the illustrative purpose of introducing the exception-handling concept. We first define it without exception handling and then improve it gradually by adding exception-handling features. Because we will be defining many different versions of the class, we will name them `AgeInputVer1`, `AgeInputVer2`, and so forth. Here's the `AgeInputVer1` class without exception handling:

```
/*
Chapter 8 Sample Class: Class to input age
File: AgeInputVer1.java
*/
import java.util.*;

class AgeInputVer1 {

    private static final String DEFAULT_MESSAGE = "Your age: ";

    private Scanner scanner;

    public AgeInputVer1( ) {
        scanner = new Scanner(System.in);
    }

    public int getAge() {
        return getAge(DEFAULT_MESSAGE);
    }
}
```

```

public int getAge(String prompt) {
    System.out.print(prompt);
    int age = scanner.nextInt();
    return age;
}
}

```

Using this service class, we can write a program that gets a person's age and replies with the year in which the person was born. Notice the program takes into consideration whether the person already had a birthday this year. Here's the program:

```

/*
Chapter 8 Sample Program: Input a person's age
File: Ch8AgeInputMain.java
*/
import java.util.*;
class Ch8AgeInputMain {
    public static void main(String[] args) {
        GregorianCalendar today;
        int age, thisYear, bornYr;
        String answer;
        Scanner scanner = new Scanner(System.in);
        AgeInputVer1 input = new AgeInputVer1( );
        age = input.getAge("How old are you? ");
        today = new GregorianCalendar( );
        thisYear = today.get(Calendar.YEAR);
        bornYr = thisYear - age;
        System.out.print("Already had your birthday this year? (Y or N)");
        answer = scanner.next();
        if (answer.equals("N") || answer.equals("n") ) {
            bornYr--;
        }
        System.out.println("\nYou are born in " + bornYr);
    }
}

```

The program works fine as long as valid input is entered. But what happens if the user spells out the age, say, nine instead of 9? An input mismatch exception is thrown because the input value nine cannot be converted to an integer by using the `parseInt` method. With the current implementation, the system will handle the thrown exception by displaying the error message

```
Exception in thread "main" java.util.InputMismatchException
    at java.util.Scanner.throwFor(Scanner.java:819)
    at java.util.Scanner.next(Scanner.java:1431)
    at java.util.Scanner.nextInt(Scanner.java:2040)
    at java.util.Scanner.nextInt(Scanner.java:2000)
    at AgeInputVer1.getAge(AgeInputVer1.java:48)
    at Ch8AgeInputMain.main(Ch8AgeInputMain.java:30)
```

and terminating the program. It would be a much better program if we could handle the thrown exception ourselves. Let's modify the `getAge` method so that it will loop until a valid input that can be converted to an integer is entered. To do this, we need to wrap the statements that can potentially throw an exception with the `try-catch` control statement. In this example, there's only one statement that can potentially throw an exception, namely,

try-catch

```
age = scanner.nextInt();
```

We put this statement inside the `try` block and the statements we want to be executed in response to the thrown exception in the matching `catch` block. If we just want to display an error message when the exception is thrown, then we can write the `try-catch` statement as follows:

```
System.out.print(prompt);

try {
    age = scanner.nextInt();
} catch (InputMismatchException e) {
    System.out.println(
        "Invalid Entry. Please enter digits only.");
}
```

A statement that could throw an exception

The type of exception to be caught

Statements in the `try` block are executed in sequence. When one of the statements throws an exception, then control is passed to the matching `catch` block and statements inside the `catch` block are executed. The execution next continues to the statement that follows this `try` block statement, ignoring any remaining statements in the `try` block. If no statements in the `try` block throw an exception, then the `catch` block is ignored and execution continues with the statement that follows this

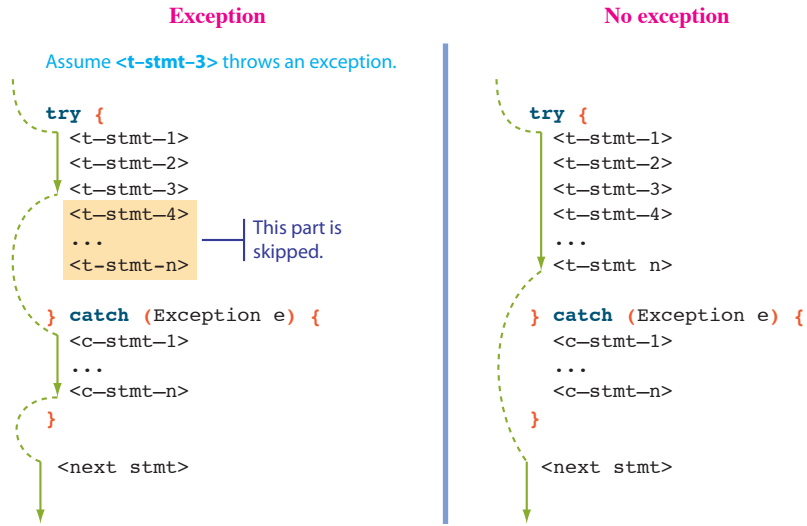

Figure 8.1 Two possible control flows of the **try-catch** statement with one **catch** block. Assume **<t-stmt-3>** throws an exception.

try-catch statement. Figure 8.1 shows the two possible control flows: one when an exception is thrown and another when no exceptions are thrown.

In the sample code, we have only one statement in the try block. If the input statement does not throw an exception, then we want to exit from the method and return the integer. If there's an exception, we display an error message inside the catch block, and repeat the input routine. To accomplish this repetition, we will put the whole try-catch statement inside a loop:

```

public int getAge(String prompt) {
    int age;
    boolean keepGoing = true;
    while (keepGoing) {
        System.out.print(prompt);

        try {
            age = scanner.nextInt();
            keepGoing = false;
        } catch (InputMismatchException e) {
            scanner.next(); //remove the leftover garbage
                           //from the input buffer
        }
        System.out.println(

```

This statement is executed only if no exception is thrown.

This will remove "garbage" left in the input buffer.

```

        "Invalid Entry.Please enter digits only.");
    }
}
return age;
}

```

Notice the first statement

```
scanner.next();
```

inside the catch block. It is used to remove any data that remain in the input buffer. When an exception is thrown, an input value that has caused an exception still remains in the input buffer. We need to remove this “garbage” from the input buffer, so we can process the next input value. If we don’t include this statement, the code will result in an infinite loop because the `nextInt` method continues to process the same invalid input.

We can get rid of the boolean variable by rewriting the statement as

```

while (true) {
    System.out.print(prompt);
    try {
        age = scanner.nextInt();
        return age;
    } catch (InputMismatchException e) {
        scanner.next(); //remove the leftover garbage
                       //from the input buffer

        System.out.println(
            "Invalid Entry. Please enter digits only.");
    }
}

```

The improved class with the exception-handling `getAge` method is named `AgeInputVer2`.

There are many types of exceptions the system can throw, and we must specify which exception we are catching in the catch block’s parameter list (there can be exactly one exception in the list). In the sample code, we are catching the input mismatch exception, and the parameter `e` represents an instance of the `InputMismatchException` class. In Java an exception is represented as an instance of the `Throwable` class or its subclasses. The `Throwable` class has two subclasses, `Error` and `Exception`. The `Error` class and its subclasses represent serious problems that should not be caught by ordinary applications, while the `Exception` class and its subclasses represent error conditions that should be caught. So for all practical purposes, we are only interested in the `Exception` class and its subclasses in our program. Later in the chapter we will learn how to define our own exception classes. We will declare these programmer-defined exception classes as subclasses of the `Exception` class.

There are two methods defined in the `Throwable` class that we can call to get some information about the thrown exception: `getMessage` and `printStackTrace`. We can call these methods inside the catch block as follows:

```
try {
    age = scanner.nextInt();
    return age;
} catch (InputMismatchException e) {
    scanner.next (); //remove the leftover garbage
                    //from the input buffer

    System.out.println(e.getMessage());
    e.printStackTrace();
}
```

With this modified code, if we enter ten as an input, then we will receive the following output:

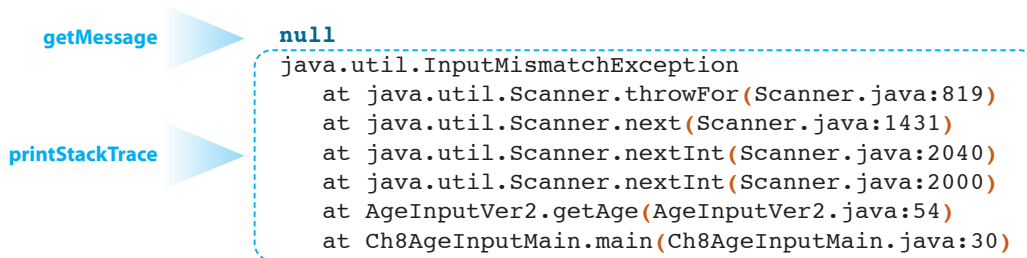

```
getMessage → null
printStackTrace → java.util.InputMismatchException
                   at java.util.Scanner.throwFor(Scanner.java:819)
                   at java.util.Scanner.next(Scanner.java:1431)
                   at java.util.Scanner.nextInt(Scanner.java:2040)
                   at java.util.Scanner.nextInt(Scanner.java:2000)
                   at AgeInputVer2.getAge(AgeInputVer2.java:54)
                   at Ch8AgeInputMain.main(Ch8AgeInputMain.java:30)
```

Notice that the result we see from the `printStackTrace` method is the one we saw when the system handled the thrown exception. The stack trace shows the sequence of calls made from the main method of the main class to the method that throws the exception.

Quick CHECK ✓

1. What will be displayed on the console window when the following code is executed and the user enters abc123 and 14?

```
Scanner scanner = new Scanner(System.in);
try {
    int num1 = scanner.nextInt();

    System.out.println("Input 1 accepted");

    int num2 = scanner.nextInt();

    System.out.println("Input 2 accepted");
} catch (InputMismatchException e) {
    System.out.println("Invalid Entry");
}
```

2. What is wrong with the following code? It attempts to loop until the valid input is entered.

```
Scanner scanner = new Scanner(System.in);

try {
    while (true) {
        System.out.print("Enter input: ");

        int num = scanner.nextInt();
    }
} catch (InputMismatchException e) {
    scanner.next();
    System.out.println("Invalid Entry");
}
```

8.2 Throwing Exceptions and Multiple catch Blocks

Compared to the original `AgeInputVer1` class, the `AgeInputVer2` class is more robust because the program does not terminate abruptly when an invalid value is entered. However, the improved class is not robust enough yet. There is still room for improvements. For example, the current implementation accepts invalid negative integers. Since negative age is not possible, let's improve the code by disallowing the input of negative integers. Notice that a negative integer is an integer, so the `nextInt` method will not throw an exception. We will define the third class, `AgeInputVer3`, to throw (and catch) an exception when the invalid input of a negative integer is detected. Here's the while loop of the modified `getAge` method of the `AgeInputVer3` class:

```
while (true) {
    System.out.print(prompt);

    try {
        age = scanner.nextInt();

        if (age < 0) {
            throw new Exception("Negative age is invalid");
        }

        return age; //input okay so return the value & exit
    } catch (InputMismatchException e) {
        scanner.next();

        System.out.println("Input is invalid.\n" +
            "Please enter digits only");
    } catch (Exception e) {
        System.out.println("Error: " + e.getMessage());
    }
}
```

Throws an exception when `age` is a negative integer.

The thrown exception is caught by this catch block.

An exception is thrown by using the throw statement. Its syntax is

```
throw <a throwable object>
```

where <a throwable object> is an instance of the Throwable class or its subclasses. As mentioned earlier, in common applications, it will be an instance of the Exception class or its subclasses. In the sample code, we threw an instance of the Exception class. When we create an instance of the Exception class, we can pass the string that describes the error. The thrown exception is caught by the corresponding catch block, and this error message is displayed.

Notice the multiple catch blocks in the sample code. When there are multiple catch blocks in a try-catch statement, they are checked in sequence, and because the exception classes form an inheritance hierarchy, it is important to check the more specialized exception classes before the more general exception classes. For example, if we reverse the order of the catch blocks to

```
try {
    ...
} catch (Exception e) {
    ...
} catch (InputMismatchException e) {
    ...
}
```

then the second catch block will never be executed because any exception object that is an instance of Exception or its subclasses will match the first catch block. When an exception is thrown, a matching catch block is executed and all other catch blocks are ignored. This is similar to the switch statement with break at the end of each case block. The execution continues to the next statement that follows the trycatch statement. When no exception is thrown, all catch blocks are ignored and the execution continues to the next statement. Figure 8.2 illustrates the control flow of the try-catch statement with multiple catch blocks.

Things to Remember



List the **catch** blocks in the order of specialized to more general exception classes. At most one **catch** block is executed, and all other **catch** blocks are ignored.

The sample code given at the beginning of this section illustrates how an exception can be thrown and caught by the matching catch block. Instead of catching the thrown exception immediately, it is possible to let others handle the exception. This can be achieved by not including a matching catch block. We assume in Figure 8.2 that one of the catch blocks will match the thrown exception, but it is not a requirement. It is possible that none of the catch blocks matches the thrown exception.

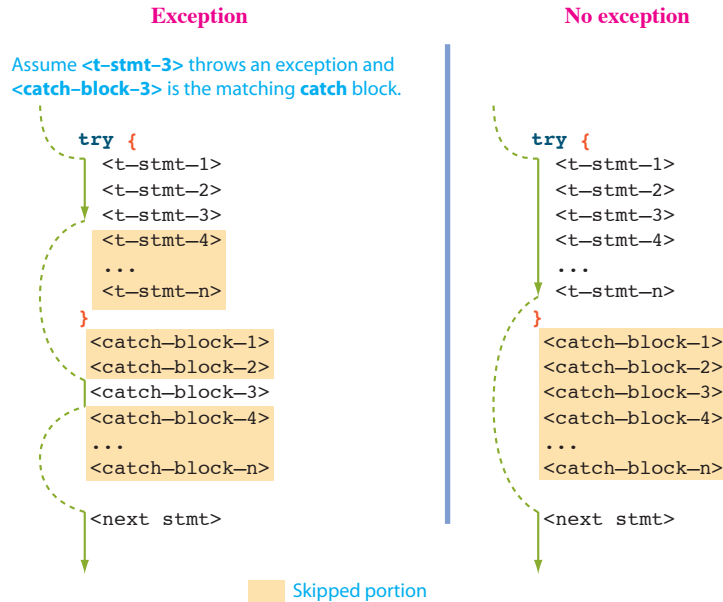

Figure 8.2 Two possible control flows of the `try-catch` statement with multiple `catch` blocks. Assume `<t-stmt-3>` throws an exception and `<catch-block-3>` is the matching `catch` block.

If there is no matching catch block, then the system will search down the stack trace for a method with a matching catch block. If none is found, then the system will handle the thrown exception. We will explain this traversing of the stack trace in greater detail in Section 8.3.

If there is a block of code that needs to be executed regardless of whether an exception is thrown, then we use the reserved word `finally`. Consider this code.

```

try {
    num = scanner.nextInt();
    if (num > 100) {
        throw new Exception("Out of bound");
    }
} catch (InputMismatchException e) {
    scanner.next();
    System.out.println("Not an integer");
} catch (Exception e) {
    System.out.println("Error: " + e.getMessage());
} finally {
    System.out.println("DONE");
}

```

If there is no error in input, then no exception is thrown and the output will be

```
DONE
```

If there is an error in input, one of the two exceptions is thrown and the output will be

```
Not an integer
DONE
```

or

```
Error: Out of bound
DONE
```

The example shows that the finally block is always executed. This feature is useful in a situation where we need to execute some cleanup code after the try-catch statement. For example, suppose we open a communication channel from our Java program to a remote Web server to exchange data. If the data exchange is successfully completed in the try block, then we close the communication channel and finish the operation. If the data exchange is interrupted for some reason, an exception is thrown and the operation is aborted. In this case also, we need to close the communication channel, because leaving the channel open by one application blocks other applications from using it. Closing a channel is much like hanging up the phone. The code to close the communication channel should therefore be placed in the finally block. Figure 8.3 shows two possible control flows for the try-catch statement with the finally clause.

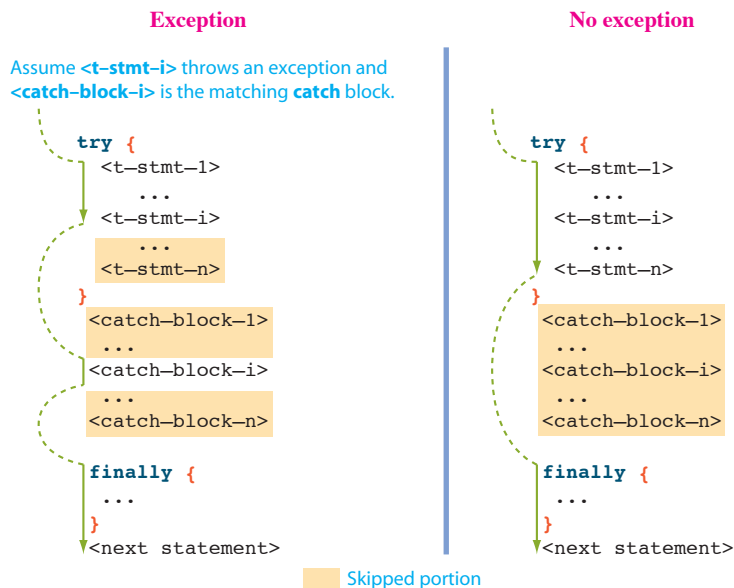

Figure 8.3 Two possible control flows of the **try-catch** statement with multiple **catch** blocks and the **finally** block. The **finally** block is always executed.

Note that even if there's a return statement inside the try block, the finally block is executed. When the return statement is encountered in the try block, statements in the finally block are executed before actually returning from the method.



1. What's wrong with the following code? Identify all errors.

```
Scanner scanner = new Scanner(System.in);

try {
    int num = scanner.nextInt();

    if (num > 100) {
        catch new Exception("Out of bound");
    }

} catch (InputMismatchException e) {

    System.out.println("Invalid Entry");

} finally(Exception e) {

    System.out.println("DONE");

}
```

2. Determine the output of the following code when the input a12 is entered.

```
Scanner scanner = new Scanner(System.in);

try {
    int num = scanner.nextInt();

    if (num < 0) {
        throw new Exception("No negative");
    }

} catch (InputMismatchException e) {

    System.out.println("Invalid Entry");

} catch (Exception e) {

    System.out.println("Error: " + e.getMessage());

} finally {

    System.out.println("DONE");

}
```

3. Determine the output of the following code when the input a12 is entered.

```
Scanner scanner = new Scanner(System.in);

try {
    int num = scanner.nextInt();

    if (num < 0) {
        throw new Exception("No negative");
    }
} catch (Exception e) {

    System.out.println("Error: " + e.getMessage());
} catch (InputMismatchException e) {

    System.out.println("Invalid Entry");
}
```

8.3 Propagating Exceptions

In Section 8.2 we introduced the possibility of no catch block matching the thrown exception, but we did not explain exactly how the system handles such a case. We stated only briefly that the system will search down the stack trace for a method with a matching catch block, and if no matching catch block is found, the system will handle the thrown exception. We now describe this mechanism in detail.

To present a precise description, we start with some definitions. When a method may throw an exception, either directly by including a throw statement or indirectly by calling a method that throws an exception, we call the method an *exception thrower*. Every exception thrower must be one of the two types: catcher or propagator. An *exception catcher* is an exception thrower that includes a matching catch block for the thrown exception, while an *exception propagator* does not. For example, the `getAge` method of the `AgeInputVer1` class is an exception propagator, while the `getAge` method of the `AgeInputVer2` class is an exception catcher. Note that the designation of a method as being a catcher or propagator is based on a single exception. Suppose a method throws two exceptions. This method can be a catcher of the first exception and a propagator of the second exception.

Let's consider the sequence of method calls shown in Figure 8.4. Method A calls method B, method B in turn calls method C, and so forth. Notice the stack trace in the figure. Every time a method is executed, the method's name is placed on top of the stack. By the time method D is executed, we have A, B, C, and D in the stack. When an exception is thrown, the system searches down the stack from the top, looking for the first matching exception catcher. Method D throws an exception, but no matching catch block exists in the method, so method D is an exception propagator. The system then checks method C. This method is also an exception propagator. Finally, the system locates the matching catch block in method B, and therefore, method B is the catcher for the exception thrown by method D.

exception
thrower

exception
catcher

exception
propagator

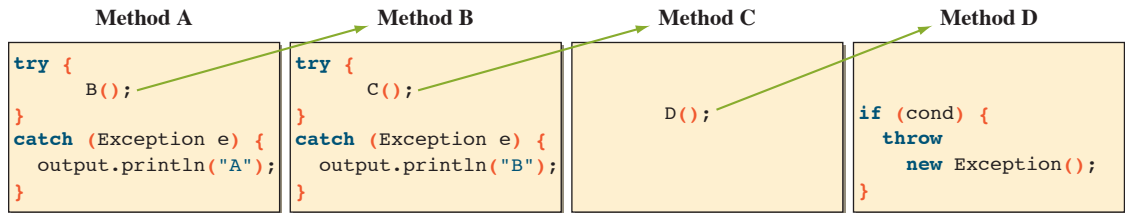

Call sequence



Stack trace



Figure 8.4 A sequence of method calls among the exception throwers. Method D throws an instance of **Exception**. The green arrows indicate the direction of calls. The red arrows show the reversing of call sequence, looking for a matching catcher. Method B is the catcher in this example. The call sequence is traced by using a stack. (Note: **output** == **System.out**.)

Method A also includes the matching catch block, but it will not be executed because the thrown exception is already caught by method B, and method B does not propagate this exception. Although the technique is not used often, an exception catcher can also be set to propagate the caught exception. For example, if we rewrite method B as

```

try {
    C();
} catch (Exception e) {
    ... //do something here
    throw e; //propagate the caught exception to the
            //method below this one in the trace stack
}

```

it is both a catcher and a propagator. With the modified method B, method A's matching catch block will get executed, because method B, in addition to handling the exception, throws the same exception, causing the system to look for a matching catcher down the stack.

We have one last detail to complete the description of the exception propagation mechanism. If a method is an exception propagator, we need to modify its

header to declare the type of exceptions the method propagates. We use the reserved word `throws` for this declaration. Methods C and D in Figure 8.4 must have the following declaration (visibility modifier and return type are not relevant here):

```
void C( ) throws Exception {
    ...
}
void D( ) throws Exception {
    ...
}
```

Without the required `throws Exception` clause, the program will not compile. There is one exception (no pun intended) to this rule. For the exceptions of the type called *runtime exceptions*, the `throws` clause is optional. For example, the `getAge` method of `AgeInputVer1` does not include the `throws` clause because `InputMismatchException` is a runtime exception. Its being optional means we can include it to explicitly state the fact if we want to. If we restate the declaration to

```
public int getAge(String prompt)
    throws InputMismatchException {
    ...
}
```

the code will compile just fine. We will explain further about different types of exceptions in Section 8.4.

Now that the exception propagation mechanism is explained, let's study how we can apply it in designing useful service classes.

First, consider the `Fraction` class from Chapter 7. The `setDenominator` method of the `Fraction` class was defined as follows:

```
public void setDenominator(int denom) {
    if (denom == 0) {
        System.out.println("Fatal Error");
        System.exit(1);
    }
    denominator = denom;
}
```

We stated in Chapter 7 that it is too drastic to terminate a whole program when one attempts (inadvertently or otherwise) to set the denominator to 0. Throwing an exception is a much better approach. Here's the modified method that throws an `IllegalArgumentException` when the value of 0 is passed as an argument:

```
public void setDenominator(int denom)
    throws IllegalArgumentException {
```

```

    if (denom == 0) {
        throw new IllegalArgumentException(
            "Denominator cannot be 0");
    }
    denominator = denom;
}

```

Now let's study another example. Consider the `AgeInputVer3` class. It disallows input of negative integers. When that happens, an exception is thrown. Instead of disallowing only negative integers, wouldn't it make more sense to restrict the valid input by specifying the lower and upper bounds? For example, we may want to restrict the input to an integer between 10 and 20 for one application and between 0 and 250 (e.g., entering the age of a building on the campus) for another application. To illustrate this concept, we will define the fourth class, `AgeInputVer4`, that allows the client programmers to specify the lower and upper bounds of acceptable input values.

The client specifies the lower and upper bounds at the time of object creation, for example,

```
AgeInputVer4 input = new AgeInputVer4(10, 20);
```

This constructor will set the lower and upper bounds to 0 and 99, respectively. The lower and upper bounds are kept as data members `lowerBound` and `upperBound`, respectively, and they are initialized in the constructor.

How should the `getAge` respond when it detects the input is outside the range of the client-designated lower and upper bounds? Instead of catching it, we will propagate the thrown exception to the caller of this method. Our responsibility as a provider of the service class is to tell the client by throwing an exception when a condition set by the client is violated. We will let the client handle the thrown exception. The condition is set by the client, so it is more appropriate for this client to decide what to do in case of an exception. For the number format exception, the `getAge` method is still the catcher because this exception is thrown when a condition not dependent on any one specific client is violated. This exception is not a client-specific exception, but a generic exception suitably handled by the service class. So the modified `getAge` method is a propagator of an `Exception` (thrown when the bounds set by the client are violated) and a catcher of an `InputMismatchException` (thrown when the input is not an integer). Here's the method:

```

public int getAge(String prompt) throws Exception {
    int age;
    while (true) {
        System.out.print(prompt);
        try {
            age = scanner.nextInt();

```



Propagates an
Exception

```

        if (age < lowerBound || age > upperBound) {
            throw new Exception("Input out of bound");
        }

        return age;
    } catch (InputMismatchException e) {
        scanner.next();
        System.out.println("Input is invalid.\n" +
            "Please enter digits only");
    }
}

```

No catch block for Exception

Things to Remember



Don't catch an exception that is thrown as a result of violating the condition set by the client programmer. Instead, propagate the exception back to the client programmer's code and let him or her handle it.

The second `getAge` method that uses a default prompt calls this method, so we need to rewrite the second `getAge` method as

```

public int getAge() throws Exception {
    return getAge(DEFAULT_MESSAGE);
}

```

This call can throw an Exception so the method header must include the correct throws clause.

We have to specify the additional data members and the constructors to complete the `AgeInputVer4` class. The new data members are declared as

```

private static final int DEFAULT_LOWER_BOUND = 0;
private static final int DEFAULT_UPPER_BOUND = 99;

private int lowerBound;
private int upperBound;

```

What about the constructors? Are the following constructors acceptable?

```

public AgeInputVer4() {
    this(DEFAULT_LOWER_BOUND, DEFAULT_UPPER_BOUND);
}

public AgeInputVer4(int low, int high) {
    lowerBound = low;
    upperBound = high;
    scanner = new Scanner(System.in);
}

```

Yes, if we didn't know about exception handling. But now with the knowledge of exception handling, we can make the class more robust by ensuring that low is less than or equal to high. If this condition is not met, then we throw an exception. The `IllegalArgumentException` class is precisely the class we can use for this situation. Here's the more robust constructor:

```
public AgeInputVer4(int low, int high)
    throws IllegalArgumentException {
    if (low > high) {
        throw new IllegalArgumentException(
            "Low (" + low + ") was " +
            "larger than high(" + high + ")");
    } else {
        lowerBound = low;
        upperBound = high;
        scanner = new Scanner(System.in);
    }
}
```

Now, what about the default constructor? Since the default constructor calls the other two-argument constructor, which can throw an exception, this constructor must handle the exception. One approach is to propagate the exception by declaring it as

```
public AgeInputVer4() throws IllegalArgumentException {
    this(DEFAULT_LOWER_BOUND, DEFAULT_UPPER_BOUND);
}
```

This declaration is problematic, however, because when we use the `throws` clause, we are announcing that this method can potentially throw an exception. But this constructor will never throw an exception as long as the class is programmed correctly. The only time this constructor can throw an exception is when we set the value for `DEFAULT_LOWER_BOUND` or `DEFAULT_UPPER_BOUND` incorrectly. It is an internal error and must be corrected. Since this constructor should not throw an exception, we might be tempted to make this constructor an exception catcher as

```
public AgeInputVer4() {
    try {
        this(DEFAULT_LOWER_BOUND, DEFAULT_UPPER_BOUND);
    } catch (IllegalArgumentException e) {
        //never happens, so do nothing
    }
}
```

Logically, this is what we want to accomplish. But syntactically, it is an error. Java requires the call to another constructor using the reserved word `this` to be the first

statement. In the bad version, the try statement is the first statement. To correct this problem, we can define a private method `init` as

```
private void init(int low, int high) {
    lowerBound = low;
    upperBound = high;
    scanner = new Scanner(System.in);
}
```

and write the two constructors as

```
public AgeInputVer4() {
    init(DEFAULT_LOWER_BOUND, DEFAULT_UPPER_BOUND);
}

public AgeInputVer4(int low, int high)
    throws IllegalArgumentException {
    if (low > high) {
        throw new IllegalArgumentException(
            "Low (" + low + ") was " +
            "larger than high(" + high + ")");
    } else {
        init(low, high);
    }
}
```

Here's the complete `AgeInputVer4` class:

```
/*
Chapter 8 Sample Class: Class to input age
File: AgeInputVer4.java
*/
import java.util.*;

class AgeInputVer4 {
    private static final String DEFAULT_MESSAGE = "Your age:";
    private static final int DEFAULT_LOWER_BOUND = 0;
    private static final int DEFAULT_UPPER_BOUND = 99;

    private int lowerBound;
    private int upperBound;

    private Scanner scanner;
```

Data members

```
public AgeInputVer4( ) {
    init(DEFAULT_LOWER_BOUND, DEFAULT_UPPER_BOUND);
}

public AgeInputVer4(int low, int high)
    throws IllegalArgumentException {
    if (low > high) {
        throw new IllegalArgumentException(
            "Low (" + low + ") was " +
            "larger than high(" + high + ")");
    } else {
        init(low, high);
    }
}

public int getAge() throws Exception {
    return getAge(DEFAULT_MESSAGE);
}

public int getAge(String prompt) throws Exception {
    int age;
    while (true) {
        System.out.print(prompt);
        try {
            age = scanner.nextInt();
            if (age < lowerBound || age > upperBound) {
                throw new Exception("Input out of bound");
            }
            return age; //input okay so return the value & exit
        } catch (InputMismatchException e) {
            scanner.next();
            System.out.println("Input is invalid.\n" +
                "Please enter digits only");
        }
    }
}

private void init(int low, int high) {
    lowerBound = low;
    upperBound = high;
    scanner = new Scanner(System.in);
}
}
```

Constructors

getAge

init



1. What's wrong with the following code?

```
public void check(int num) {
    if (num < 0) {
        throw new Exception();
    }
}
```

2. What is the difference between the reserved words `throw` and `throws`?
3. What's wrong with the following code?

```
public InputMismatchException getData( ) {
    Scanner scanner = new Scanner(System.in);

    try {
        System.out.print("Input: ");
        int num = scanner.nextInt();

        return num;
    }
}
```

8.4 | Types of Exceptions

We mentioned briefly in Section 8.1 that all types of thrown errors are instances of the `Throwable` class or its subclasses. Serious errors that signal abnormal conditions are represented by the instances of the `Error` class or its subclasses. Exceptional cases that common applications are expected to handle are represented by the instances of the `Exception` class or its subclasses. Figure 8.5 shows a very small portion of the inheritance hierarchy rooted in the `Throwable` class.

checked and
unchecked
exception

There are two types of exceptions: checked and unchecked. A *checked exception* is an exception that is checked at compile time. All other exceptions are *unchecked exceptions*, also called *runtime exceptions*, because they are unchecked at compile time and are detected only at runtime. Trying to divide a number by 0 (`ArithmeticException`) and trying to convert a string with letters to an integer (`NumberFormatException`) are two examples of runtime exceptions.

If a method is a propagator (a method that throws but does not catch an exception) of checked exceptions, then the method must have the `throws` clause. If a method is a propagator of runtime exceptions or errors (instances of `Error` or its subclasses), the `throws` clause is optional. When we call a method that can throw checked exceptions, then we must use the try-catch statement and place the call in the try block, or we must modify our method header to include the appropriate `throws` clause. When we call a method that can throw runtime exceptions or errors, then there's is no such requirement. We just make a call in our method. Figure 8.6 shows the valid callers of a method that throws checked exceptions, and Figure 8.7 shows the valid callers of a method that throws runtime, or unchecked, exceptions.

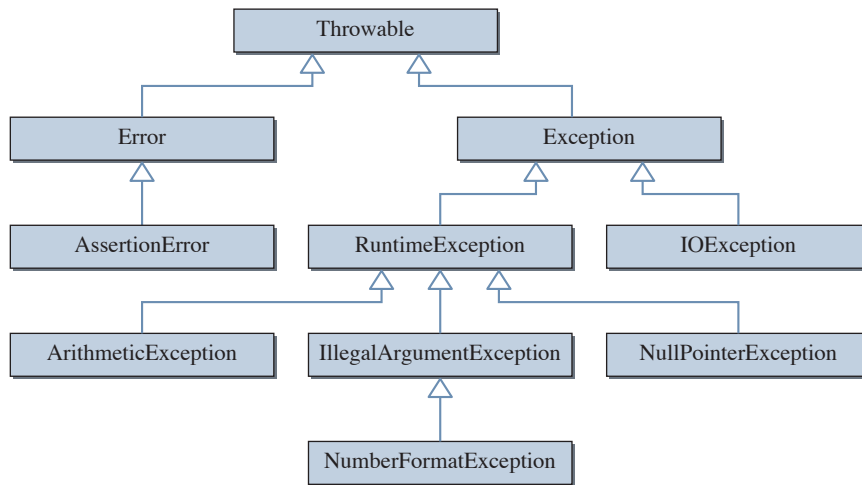

Figure 8.5 Some classes in the inheritance hierarchy from the **Throwable** class. There are over 60 classes in the hierarchy.

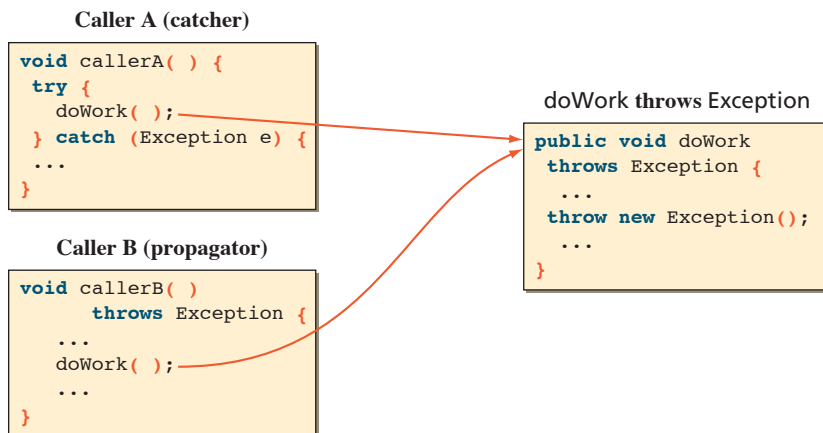

Figure 8.6 Callers of a method that can throw a checked exception must explicitly include the **try-catch** statement in the method body or the **throws** clause in the method header.

Enforcing the requirement of explicitly handling runtime exceptions means, for all methods we write, that they must either have the **throws** clause in the header or have the **try-catch** statement in the body because almost every method we call from our methods can throw runtime exceptions. This is hardly effective programming so we don't have to handle runtime exceptions explicitly in the program. For the errors of type **Error** and its subclasses, they indicate problems too serious for any ordinary application to handle, so we are not required to handle them explicitly. There's really nothing we can do even if we catch them, so we don't.

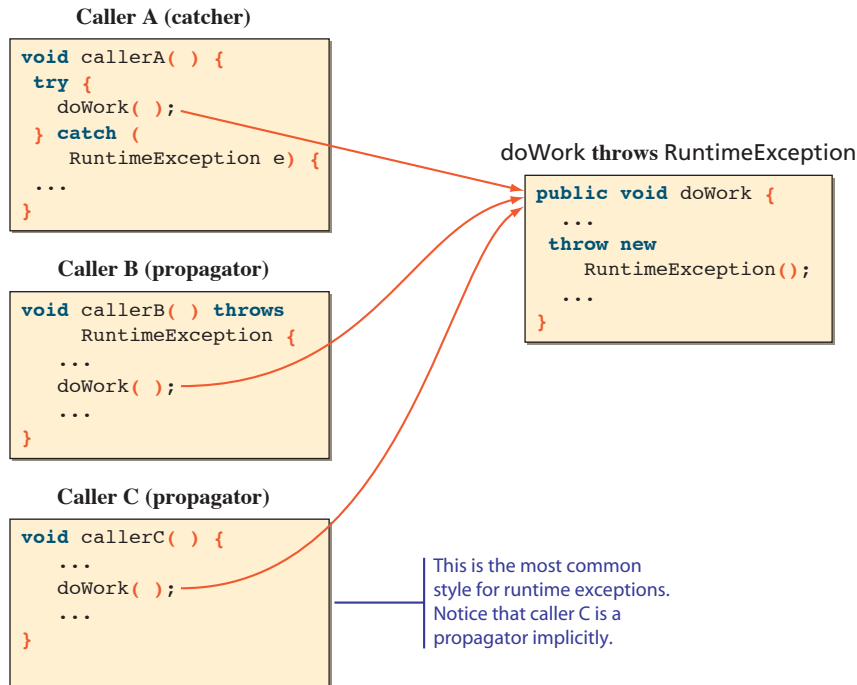

Figure 8.7 It is optional for the callers of a method that can throw runtime, or unchecked, exceptions to include the **try-catch** statement in the method body or the **throws** clause in the method header.

Things to Remember



If a method throws a checked exception, the caller of this method must explicitly include the **try-catch** statement or the **throws** clause in the method header. If a method throws a runtime, or unchecked, exception, the use of the **try-catch** statement or the **throws** clause is optional.

Quick CHECK

1. Is this code wrong?

```
public void check(int num) {
    if (num < 0) {
        throw new IllegalArgumentException();
    }
}
```

2. What is the difference between the checked and unchecked exceptions?

8.5 | Programmer-Defined Exceptions

In the `AgeInputVer4` class, the `getAge` methods throw an instance of the `Exception` class. The catch clause of the caller of the `getAge` method can use the `getMessage` method to retrieve the error message or use `printStackTrace` to display the sequence of method calls from the main method to the method that threw an exception. But there's no way for the client to get any other useful information such as the value actually entered by the user. Instead of using generic exception classes, we can define our own exception classes so we can attach useful information to the exception objects.

Let's define a class named `AgeInputException` as a subclass of the `Exception` class. To provide useful information to the client, we will define the class so the instances will carry three pieces of information: lower bound, upper bound, and the value entered by the user (in addition to the message inherited from the `Exception` class). We will define three public methods to access these data. Here's the class definition:

```

/*
   Chapter 8 Sample Class: Customized Exception Class
   File: AgeInputException.java
*/
class AgeInputException extends Exception {

    private static final String DEFAULT_MESSAGE = "Input out of bounds";

    private int lowerBound;
    private int upperBound;
    private int value;

    public AgeInputException(int low, int high, int input) {
        this(DEFAULT_MESSAGE, low, high, input);
    }

    public AgeInputException(String msg,
                              int low, int high, int input) {
        super(msg);

        if (low > high) {
            throw new IllegalArgumentException();
        }

        lowerBound = low;
        upperBound = high;
        value      = input;
    }
}

```

```

public int lowerBound() {
    return lowerBound;
}
public int upperBound() {
    return upperBound;
}
public int value() {
    return value;
}
}

```

The new `AgeInputVer5` class is essentially the same as the `AgeInputVer4` class except the `getAge` method of the new class throws an `AgeInputException`. A sample main class that uses the `AgeInputVer5` is as follows:

```

/*
Chapter 8 Sample Program: Input a person's age
File: Ch8TestAgeInputVer5.java
*/
class Ch8TestAgeInputVer5 {
    public static void main( String[] args ) {
        int entrantAge;
        try {
            AgeInputVer5 input = new AgeInputVer5(25, 50);
            entrantAge = input.getAge("Your Age:");
            System.out.println("Input Okay. Age = " + entrantAge);
        } catch (AgeInputException e) {
            System.out.println(
                "Error: " + e.value() + " is entered. It is " +
                "outside the valid range of [" + e.lowerBound() +
                ", " + e.upperBound() + "]);
        }
    }
}

```

e's methods are called to get info

Things to Remember



To provide useful information to the client programmers when an exception occurs, define a new exception class. Make this customized exception class a subclass of **Exception**.

Hints, & Tips, Pitfalls



When we create a new customized exception class, we should define it as a checked exception, and the most logical choice for its superclass is the **Exception** class. We should not define the customized exception class as an unchecked exception. If we did, then the client programmers would have an option of omitting the **try-catch** statement or the **throws** clause in their code. This is not a good idea. The goal of defining a customized exception class is to ensure that the client programmers handle the thrown exceptions of the customized class explicitly in their code, to increase the robustness of the whole program.

Quick CHECK

1. When do we want to define a customized exception class?
2. Should a customized exception class be a checked or unchecked exception?

8.6 | Assertions

In this section we will describe a Java assertion and explain how to use it effectively in our programs. A Java assertion is a language feature we use to detect logical errors in a program. We will illustrate the key points with a very simple class that includes a logical error. Because the sample class is simple, the use of assertion may not seem so helpful. Keep in mind that this class is for illustrative purposes only. The real benefit of using the assertion feature becomes obvious when the program logic gets more complex and the number of classes in the program increases.

Here's a bank account class that allows withdrawals and deposits. There's one logical error in the class:

```
class BankAccount {
    private double balance;

    public BankAccount(double initialBalance) {
        balance = initialBalance;
    }
}
```

Here's a logical error. We should add the amount.

If this boolean expression results in **false**, then an **AssertionError** is thrown.

```

public void deposit(double amount) {
    double oldBalance = balance;
    balance -= amount;
    assert balance > oldBalance;
}
public void withdraw(double amount) {
    double oldBalance = balance;
    balance -= amount;
    assert balance < oldBalance;
}
public double getBalance( ) {
    return balance;
}
}

```

Notice the two occurrences of the reserved word `assert` in the class definition. The syntax for the `assert` statement is

```
assert <boolean expression> ;
```

where `<boolean expression>` represents the condition that must be true if the code is working correctly. When the statement is executed, the `<boolean expression>` is evaluated. If it results in true, then the normal execution of the program continues. Otherwise, an `AssertionError` (subclass of `Error`) is thrown.

In this example, we want to assert that `balance` is more than `oldBalance` when we deposit and less than `oldBalance` when we withdraw, so we write

```
assert balance > oldBalance;
```

and

```
assert balance < oldBalance;
```

at the end of the `deposit` and `withdraw` methods, respectively.

Now let's see what happens when we use this `BankAccount` class in our program. Here's a simplistic main class to test the `BankAccount` class:

```

import javax.swing.*;
class Ch8TestAssertMain {
    public static void main(String[] args) {
        BankAccount acct = new BankAccount(200);
        acct.deposit(25);
        System.out.println(
            "Current Balance: " + acct.getBalance());
    }
}

```

To run this program with the assertion feature enabled, we must include the designation `-ea` as follows:

```
java -ea Ch8TestAssertMain
```

(*Note:* For most Java IDE, you specify this option in the Preference dialog. Please consult your Java IDE for details.)

If we do not provide the `-ea` option, then the program is executed without checking the assertions. When do we ever want to ignore the assertions we intentionally included in the program? Checking all assertions included in the program can be quite costly. By having an option of enabling or disabling the assertions, we can choose to enable the assertions while developing and testing the program and disable them once the program is fully developed and tested.

Things to Remember



To run the program with assertions enabled, use

```
java -ea <main class>
```

With the `assert` statements enabled, executing the `Ch8TestAssertMain` main class will result in the following error message:

```
Exception in thread "main" java.lang.AssertionError
    at BankAccount.deposit(BankAccount.java:13)
    at Ch8TestAssertMain.main(Ch8TestAssertMain.java:34)
```

The error message indicates an `AssertionError` is thrown at line 13 (the actual line number would be different if the source code included comments) of the `BankAccount` class, which is the `assert` statement

```
assert balance > oldBalance;
```

We can use the second form of the `assert` statement to provide a customized error message. The syntax for the second form is

```
assert <boolean expression > : <expression>;
```

where `<expression>` represents the value that is passed as an argument to the constructor of the `AssertionError` class. The value serves as the detailed message of a thrown error. For example, using the second form, we can rewrite the `deposit` method as

```
public void deposit(double amount) {
    double oldBalance = balance;

    balance -= amount;
```

```

    assert balance > oldBalance :
        "Serious Error -- balance becomes less" +
        "after deposit";
}

```

With this modified deposit method, the error message will be

```

Exception in thread "main" java.lang.AssertionError:
    Serious Error -- balance becomes less after deposit
    at BankAccount.deposit(BankAccount.java:14)
    at Ch8TestAssertMain.main(Ch8TestAssertMain.java:34)

```

Encountering this error message during the development, we are made aware of the existence of a bug in the program. Without the assertion feature, we may not be able to detect the bug until very late in the development, or we may not be able to detect it at all.

Again, for a small class such as `BankAccount`, the benefit of using assertions may not be obvious. However, in designing and building classes that solve difficult and complex problems, effective use of assertions can be an indispensable aid, especially when it is combined with a full set of testing. We will be seeing more examples of assertions (and exceptions, also) in the later sample code.

Types of Assertions

postcondition
assertion

precondition
assertion

control flow
invariant

The type of assertion we see in the `withdraw` and `deposit` methods is called a *postcondition assertion*. This assertion checks for a condition that must be true after a method is executed. Opposite to the postcondition assertion is a *precondition assertion*, a checking of condition that must be true before a method is executed. The third type of assertion is called a *control flow invariant*. Consider the following switch statement. It adds the appropriate fee to the tuition based on whether the student is a dorm resident or a dorm resident or a commuter.

```

switch (residenceType) {
    case COMMUTER:      totalFee = tuition + parkingFee;
                        break;
    case DORM_RESIDENT: totalFee = tuition + roomAndBoard;
                        break;
}

```

Now every student must be a dorm resident or a commuter, so if the variable `residenceType` has a value other than `COMMUTER` or `DORM_RESIDENT`, then there's a bug somewhere. To detect such bug, we can rewrite the statement as

```

switch (residenceType) {
    case COMMUTER:      totalFee = tuition + parkingFee;
                        break;
}

```

```

case DORM_RESIDENT: totalFee = tuition + roomAndBoard;
                    break;

default:           assert false:
                    "Value of residenceType " +
                    "is invalid. Value = " +
                    residenceType;
}

```

This statement documents the fact that the default case should never be executed when the program is running correctly. This is called a *control flow invariant* because the control must flow invariably to one of the two cases. Alternatively, we can place an assertion before the switch statement as

```

assert (residenceType == COMMUTER ||
        residenctType == DORM_RESIDENT) :
        "Value of residenceType is invalid. Value = " +
        residenceType;

switch (residenceType) {

    case COMMUTER:    totalFee = tuition + parkingFee;
                    break;

    case DORM_RESIDENT: totalFee = tuition + roomAndBoard;
                    break;

}

```

Differentiating Assertions and Exceptions

Because both the assertion and the exception mechanisms are intended to improve the program reliability, their use is often mixed up. For example, if we are not attentive, we could end up using the assertion feature wrongly in places where exceptionhandling routines should be used. Consider the following case. In defining the deposit and the withdraw methods, we did not bother to check the value of the parameter (for the sake of a simplified class definition). The passed amount must be greater than zero for the methods to work correctly. How shall we include such testing? One possibility (a wrong approach) is to use the assertion feature as (we only show the withdraw method).

```

public void withdraw(double amount) {

    assert amount > 0;

    double oldBalance = balance;

    balance -= amount;

    assert balance < oldBalance;

}

```

This is not a correct use of assertions. We should not use the assertion feature to ensure the validity of an argument. In principle, we use assertions to detect the internal programming errors, and we use exceptions to notify the client programmers of the misuse of our classes. The `BankAccount` class is intended as a service class used by many different programs. It is the responsibility of the client programmers to pass the valid arguments. If they don't, then we throw an exception to notify them of the misuse. Another problem is that assertions can be enabled or disabled when the program is run. But the validity checking of the arguments should never be disabled.

Things to Remember



Use assertions to detect internal errors. Use exceptions to notify the client programmers of the misuse of our class.

The correct way to implement the methods is as follows (only the `withdraw` method is shown here):

```
public void withdraw(double amount)
    throws IllegalArgumentException {
    if (amount <= 0) {
        throw new IllegalArgumentException(
            "Amount must be positive");
    }
    double oldBalance = balance;
    balance -= amount;
    assert balance < oldBalance;
}
```



1. Why is the following code wrong?

```
public void doWork(int num) {
    assert num > 0;
    total += num;
}
```

2. Name three types of assertions.

8.7 Sample Development

Keyless Entry System

We will develop a program that simulates a secure keyless entry system for a dormitory. Inside the entrance hall of a dorm, there is an entry system where the dorm residents must enter their names, room numbers, and passwords. Upon entry of valid data, the system will unlock the inner door that leads to the dorm's living quarters. To implement this program, two helper classes are provided. The **Door** class simulates unlocking of the inner door. The **Dorm** class manages resident information. An instance of the **Dorm** class is capable of adding and deleting resident information, reading and saving resident information from and to a file, and retrieving information if given the resident's name. We can verify the validity of the entered data by checking them against the information kept by a **Dorm** object.

You
Might
Want to
Know



We can turn our simulation program into a real one by replacing the **Door** class with a class that actually controls the door. Java provides a mechanism called Java Native Interface (JNI) which can be used to embed a link to a low-level device driver code, so calling the **open** method actually unlocks the door.

Problem Statement

*Implement a sentry program that asks for three pieces of information: resident's name, room number, and a password. A password is any sequence of 8 or more characters and is unique to an individual dorm resident. If everything matches, then the system unlocks and opens the door. We assume no two residents have the same name. Use the provided support classes **Door** and **Dorm**.*

Overall Plan

To provide a complete system, we actually have to write two separate programs. The first one is the administrative module for adding, removing, and updating the resident information. The second is the user module that interacts with the residents. Figure 8.8 shows the program diagrams for the two modules.

In this section, we implement the user module. The administrative module is left as an exercise. To begin our development effort, we must first find out the capabilities of the **Dorm** and **Door** classes. Also, for us to implement the class correctly, we need the specification of the **Resident** class.

Resident

The **Resident** class maintains information on individual dorm residents. We will be dealing with many instances of this class in the program. A password assigned to a resident

8.7 Sample Development—continued

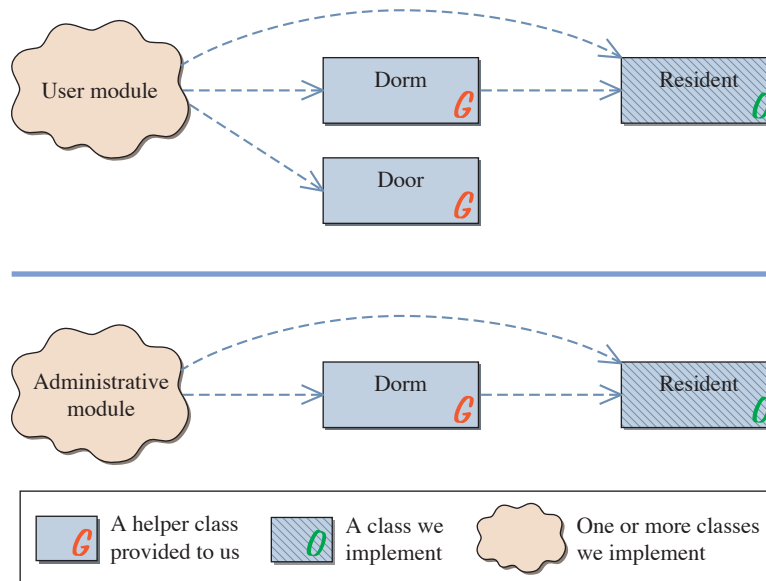

Figure 8.8 Program diagrams for the user and administrative modules. Notice the same **Dorm** and **Resident** classes are used in both programs. User and administrative modules will include one or more classes (at least one is programmer-defined).

must be a sequence of 8 or more characters. For this class to work properly with the **Dorm** class, the class must include these public methods:

Public Methods of Resident	
public	<code>Resident()</code> Default constructor that creates a <code>Resident</code> object with name = "unassigned", room = "000", and id = "XY12#\$ab".
public	<code>Resident(String name, String room, String password)</code> throws <code>IllegalArgumentException</code> Creates a <code>Resident</code> object with the passed values. <code>IllegalArgumentException</code> is thrown when the given password has less than four or more than eight characters.
public void	<code>setName(String name)</code> Assigns the name.
public void	<code>setPassword(String id)</code> throws <code>IllegalArgumentException</code> Assigns the password. <code>IllegalArgumentException</code> is thrown when the given password has less than four or more than eight characters.

```

public void setRoom(String room)
    Assigns the room.
public String getName( )
    Returns the name.
public String getPassWord( )
    Returns the password.
public String getRoom( )
    Returns the room number.

```

One important restriction to the **Resident** class is the requirement for the class to implement the **Serializable** interface. Because the **Resident** objects are saved to a file, Java requires the class definition to include the phrase **implements Serializable** as

```

import java.io.*;
class Resident implements Serializable {
    ...
}

```

Details on the significance of the clause **implements Serializable** will be given when we discuss the file input and output in Chapter 12.



Remembering all those passwords for the laptop, school portal, Yahoo! account, and others can be quite tedious and daunting. But using an easy-to-remember password such as your birthday or the name of your childhood friend is not a good idea because it is not secure. Dictionary words, proper nouns, or simply attaching numbers to the words are not secure either. They can be compromised quite easily by those unscrupulous souls using password cracking tools. To improve its security, include at least one (preferably two) of each of the following characters in your password:

- Uppercase letters (A, B, C, ...)
- Lowercase letters (a, b, c, ...)
- Digits (0, 1, 2, ...)
- Symbols (#, \$, @, ...)

Your password should include a minimum of six characters. You can find out more about password security at

<http://www.securitystats.com/tools/password.php>

and

<http://www.microsoft.com/protect/yourself/password/create.mspx>

Things to Remember



*For any object we need to save to a file, its class definition must include the phrase **implements Serializable**.*

8.7 Sample Development—continued

Dorm

The **Dorm** class is a helper class provided to us. A **Dorm** object is capable of managing a list of **Resident** objects. It allows the client to add, delete, and retrieve **Resident** objects. In addition, it is capable of saving a list to a file or reading a list from a file. By having these file input and output features, our program can work with different lists of residents much as a word processor can work with different documents (files). The class definition is as follows:

Public Methods of Dorm

```

public Dorm( )
    Default constructor that creates a Dorm object.

public Dorm(String filename)
    Creates a Dorm object with the resident list read from the file with the
    name filename. Throws FileNotFoundException when the designated
    file cannot be found and IOException when the file cannot be read.

public void openFile(String filename)
    Reads the resident list from the designated file. Throws
    FileNotFoundException when the designated file cannot be found and
    IOException when the file cannot be read.

public void saveFile(String filename)
    Saves the resident list to the designated file. Throws IOException when the
    file cannot be saved.

public void add(Resident resident)
    Adds the resident to the list. Throws IllegalArgumentException
    when a resident with the same name already exists in the list. We do not allow
    duplicate names. Every resident must have a unique name.

public void delete(String name)
    Deletes the designated resident from the list. If no such resident is in the list,
    nothing happens.

public Resident getResident(String name)
    Returns the Resident object with the given name. Returns null if no
    matching Resident is found.

public String getResidentList( )
    Returns a list of residents as a String. A line separator is used after each
    resident. For each resident, the list contains his or her name, room number,
    and password.

```

Door

The **Door** class is another helper class. It simulates the opening of the door. In a real control program, a **Door** object can have an embedded low-level device driver code,

so it really opens the door. The class definition is as follows:

Public Methods of Door	
<code>public Door ()</code>	Default constructor that creates a new Door object.
<code>public void open ()</code>	Opens the door. For this simulator class, it displays a simple message.

overall
design

Now let's study the overall design of the program. In addition to the given helper classes and the **Resident** class, what other classes should we define for this program? As the number of classes gets larger, we need to plan the classes carefully. For this program, we will define a controller class named **Ch8EntranceMonitor** whose instance will manage all other objects. We will set this class as the program's main class. The user interface of the program is handled by the **InputHandler** class. Its instance is used to allow the user to enter his or her name, room number, and password. After the required input data are entered by the user, a **Ch8EntranceMonitor** checks the validity of the input data with help from a service **Dorm** object. If the **Dorm** object confirms the input data, the controller then instructs another service object, an instance of **Door**, to open the door. The following is our working design document, and Figure 8.9 is the program diagram.

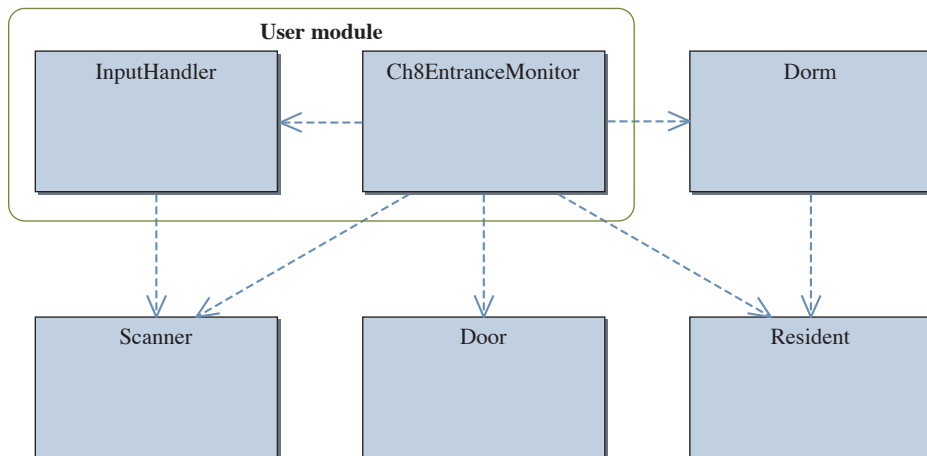

Figure 8.9 The program diagram for the **Ch8EntranceMonitor** program. There are two classes in the user module.

8.7 Sample Development—continued

program
classes**Design Document: Ch8EntranceMonitor**

Class	Purpose
Ch8EntranceMonitor	The top-level control object manages other objects in the program. This is an instantiable main class.
Door	The given predefined class simulates the opening of a door.
Dorm	The given predefined class maintains a list of Resident objects.
InputHandler	The user interface class is for handling input routines.
Resident	An instance of this class models a single resident of a dorm.

We will implement the user module in three major steps:

develop-
ment steps

1. Define the **Resident** class and explore the **Dorm** class. Start with a program skeleton to test the **Resident** class.
2. Define the user interface **InputHandler** class. Modify the top-level control class as necessary.
3. Finalize the code by making improvements and tying up loose ends.

Step 1 Development: Program Skeletonstep 1
design

Our first task is to find out about the given **Dorm** class. (The **Door** class is a very simple simulator class so there's not much to explore.) To be able to test-run the **Dorm** class, we must provide the **Resident** class, so this will be our first step. The purpose of the skeleton main class in this step is to verify the operations of the **Dorm** class.

The specification for the **Resident** class was given to us, so our task is to implement it according to the specification. No design work is necessary. When we can interact with an instance of the **Dorm** class correctly, it confirms that our implementation of the **Resident** class is working. To verify the key operations of the **Dorm** class, the top-level supervisor object **Ch8EntranceMonitor** will open a file and list the contents of the file.

step 1 code

Here's the **Resident** class:

```

/*
Chapter 8 Sample Development: Keyless Entry System.
File: Resident.java
*/

```

```

import java.io.*;

class Resident implements Serializable {

    private String name;
    private String room;
    private String password;

    public Resident( ) {
        this("unassigned", "000", "XY12#$ab");
    }

    public Resident(String name, String room, String pwd)
        throws IllegalArgumentException {
        setName(name);
        setRoom(room);
        setPassword(pwd);
    }

    public String getName( ) {
        return name;
    }

    public String getPassword( ) {
        return password;
    }

    public String getRoom( ) {
        return room;
    }

    public void setName(String name) {
        this.name = name;
    }

    public void setPassword(String pwd) {
        int length = pwd.length();

        if (length < 8) {
            throw new IllegalArgumentException();
        } else {
            this.password = pwd;
        }
    }

    public void setRoom(String room) {
        this.room = room;
    }
}

```

Data members

Constructors

Accessors

Mutators

8.7 Sample Development—continued

The skeleton main class is defined as follows:

```

/*
Chapter 8 Sample Development: Keyless Entry System. (Step 1)
File: Ch8EntranceMonitor.java
*/
import java.util.*;
import java.io.*;

class Ch8EntranceMonitor { //Step 1 main class
    private Dorm manager;
    private Scanner scanner;
    public Ch8EntranceMonitor( ) {
        manager = new Dorm();
        scanner = new Scanner(System.in);
    }
    public static void main(String[] args) {
        Ch8EntranceMonitor sentry = new Ch8EntranceMonitor();
        sentry.start();
    }
    public void start( ) {
        openFile( );
        String roster = manager.getResidentList();
        System.out.println(roster);
    }
    private void openFile( ) {
        String filename;
        while (true) {
            System.out.println("File to open ('x' to cancel):");
            filename = scanner.next();
            if (filename.equals("x")) { //input routine is canceled
                System.out.println("Program is canceled.");
                System.exit(0);
            }
        }
    }
}

```

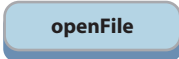
```

try {
    manager.openFile(filename);
    return;
} catch (FileNotFoundException e) {
    System.out.println("No such file");
} catch (IOException e) {
    System.out.println("Error in reading file");
}
}
}
}

```

step 1 test

The purpose of step 1 testing is to verify that the **Dorm** class is used correctly to open a file and get the contents of the file. To test it, we need a file that contains the resident information. A sample test file can be created by executing the following program, which we can modify to create other test data files.

```

/*
Chapter 8 Sample Development: Keyless Entry System.
A simple class to create dummy test data.
File: SampleCreateResidentFile.java
*/
import java.util.*;
import java.io.*;

class SampleCreateResidentFile {
    public static void main(String[] args) throws IOException {
        Resident res;
        Dorm manager = new Dorm( );

        res = new Resident("john", "1-101", "1AB#2!xb");
        manager.add(res);

        res = new Resident("java", "1-102", "XXyy22&#");
        manager.add(res);

        res = new Resident("jill", "3-232", "!!#DxA2a4");
        manager.add(res);
    }
}

```

8.7 Sample Development—continued

```

res = new Resident("jack", "3-232", "2%Az8#Qm");
manager.add(res);

Scanner scanner = new Scanner(System.in);
System.out.println("Save to which file:");
String filename = scanner.next();

manager.saveFile(filename);

System.exit(0); //terminate the program
}
}

```

Step 2 Development: Create the User Interface

step 2
design

In the second development step, we will implement the user interface class **InputHandler**, whose task is to get three pieces of information. The main controller **Ch8EntranceMonitor** will call an **InputHandler** to get input data. An **InputHandler** will then go through a sequence of getting the three pieces of data. Once the data are entered, **Ch8EntranceMonitor** will ask the **InputHandler** for these data. The logic of **Ch8EntranceMonitor** can be expressed as follows:

```

InputHandler input = new InputHandler();
. . .
input.getInput();

String name = input.getName();
String room = input.getRoomNumber();
String pwd = input.getPassword();

```

Given the input data, we can check for the match as

```

Dorm manager = new Dorm();
. . .
Resident res = manager.getResident(name);

if (res == null) {
    System.out.println("Invalid Entry");
}

```

```

    } else if (res.getName().equals(name) &&
              res.getRoom().equals(room) &&
              res.getPassword().equals(password)) {

        door.open();

    } else {
        System.out.println ("Invalid Entry");
    }
}

```

The **getInput** method of the **InputHandler** class calls the scanner three times to get the name, room, and password. Each input is recorded in the corresponding data member. The accessors, such as **getName**, will simply return the value of the requested data member.

step 2 code

We will list first the **InputHandler** class and then the modified **Ch8Entrance-Monitor** class. Here's the **InputHandler** class:

```

/*
Chapter 8 Sample Development: Keyless Entry System
File: InputHandler.java
*/
import java.util.*;
class InputHandler {

    private static final String BLANK = "";

    private String name;
    private String room;
    private String pwd;
    private Scanner scanner;

    public InputHandler( ) {

        name = BLANK;
        room = BLANK;
        pwd = BLANK;
        scanner = new Scanner(System.in);

    }

    public void getInput( ) {

        System.out.print("Enter Name:");
        name = scanner.next();

        System.out.print("Enter Room No.:");
        room = scanner.next();

        System.out.print("Enter Password:");
        pwd = scanner.next();

    }
}

```

Data members

Constructor

getInput

8.7 Sample Development—continued

```

public String getName( ) {
    return name;
}

public String getRoom( ) {
    return room;
}

public String getPassword( ) {
    return pwd;
}
}

```

Accessors

The main class is now modified to control an **InputHandler** object and to check entered information as the resident list maintained by a **Dorm** object. Here's the step 2 **Ch8EntranceMonitor** class:

```

/*
Chapter 8 Sample Development: Keyless Entry System.
File: Ch8EntranceMonitor.java (Step 2)
*/
import java.util.*;
import java.io.*;

class Ch8EntranceMonitor {
    private Dorm manager;
    private Door door;
    private InputHandler input;
    private Scanner scanner;
    public Ch8EntranceMonitor( ) {
        manager = new Dorm();
        scanner = new Scanner(System.in);
        input = new InputHandler();
        door = new Door();
    }
}

```

Data members

Constructors

```

public static void main(String[] args) {
    Ch8EntranceMonitor sentry = new Ch8EntranceMonitor();
    sentry.start();
}

public void start( ) {
    openFile( );

    String roster = manager.getResidentList(); //TEMP
    System.out.println(roster); //TEMP

    processInputData();
}

private void openFile( ) {
    String filename;

    while (true) {
        System.out.println("File to open ('x' to cancel):");
        filename = scanner.next();

        if (filename.equals("x")) { //input routine is canceled
            System.out.println("Program is canceled.");
            System.exit(0);
        }

        try {
            manager.openFile(filename);
            return;
        } catch (FileNotFoundException e) {
            System.out.println("No such file");
        } catch (IOException e) {
            System.out.println("Error in reading file");
        }
    }
}

private void processInputData( ) {
    String name, room, pwd;

    while (true) {
        input.getInput();

        name = input.getName();
        room = input.getRoom();
        pwd = input.getPassword();
    }
}

```

start

openFile

processInputData

8.7 Sample Development—continued

```

        validate(name, room, pwd);
    }
}

private void validate(String name, String room, String password) {
    Resident res = manager.getResident(name);
    if (res == null) {
        System.out.println("Invalid Entry");
    } else if (res.getName().equals(name) &&
               res.getRoom().equals(room) &&
               res.getPassword().equals(password)) {
        door.open();
    } else {
        System.out.println("Invalid Entry");
    }
}
}
}

```



Notice that the loop inside the **processInputData** method is an infinite loop. In other words, when the program starts, it will execute indefinitely. To terminate such a program, you must either close the Command window or select an appropriate menu choice (or click on a toolbar icon) in your Java IDE. We will discuss another way to terminate the program in step 3.

step 2 test

The purpose of step 2 testing is to verify the correct behavior of an **InputHandler** object. We need to test both successful and unsuccessful cases. We must verify that the door is in fact opened when valid information is entered. We must also verify that the error message is displayed when there's an error in input. We should test invalid cases such as entering nonexistent name, correct name but wrong password, not entering all information, and so forth.

Step 3 Development: Improve and Finalize

There are several key improvements we can make to the program. The first and foremost is the improved user interface. Instead of getting three pieces of data individually by using a scanner, it would be nicer to have a frame window such as the one shown in Figure 8.10, where the user can enter all three pieces of information. We will describe how to develop such a frame window in Chapter 14.

Another improvement is to allow the administrator to terminate the program by entering special code. This is left as an exercise.

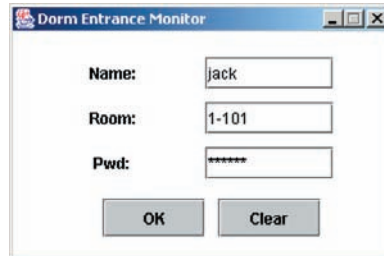

Figure 8.10 A frame window that allows the user to enter the three pieces of information together. Notice the input entered for the password is displayed back to the user as a sequence of asterisks.

Summary

- Two techniques to improve program reliability are exception handling and assertion.
- Exception handling is another type of control flow.
- An exception represents an error condition, and when it occurs, we say an exception is thrown.
- A thrown exception must be handled by either catching it or propagating it to other methods.
- If the program does include code to handle the thrown exceptions, then the system will handle them.
- A single method can be both a catcher and a propagator of an exception.
- The standard classes described or used in this chapter are

Throwable	RuntimeException
Error	IllegalArgumentException
Exception	InputMismatchException
IOException	
- The assertion feature is available from Java 2 SDK 1.4. You must use this or the later version of the compiler to use assertions in the program.
- The assertion feature is used to detect internal logic errors.

Key Concepts

exceptions	exception hierarchy
try-catch	programmer-defined exceptions
finally	assertions
throws	precondition assertions
throw	postcondition assertions

Chapter 8 Exercises

Review Exercises

1. Determine the output of the following code when the input is (a) -1 , (b) 0 , and (c) $12XY$.

```
Scanner scanner = new Scanner(System.in);
try {
    int num = scanner.nextInt();
    if (num != 0) {
        throw new Exception("Not zero");
    }
    System.out.println("I'm happy with the input.");
} catch (InputMismatchException e) {
    System.out.println("Invalid Entry");
} catch (Exception e) {
    System.out.println("Error: " + e.getMessage());
}
```

2. Determine the output of the following code when the input is (a) -1 , (b) 0 , and (c) $12XY$. This is the same question as Exercise 1, but the code here has the finally clause.

```
Scanner scanner = new Scanner(System.in);
try {
    int num = scanner.nextInt();
    if (num != 0) {
        throw new Exception("Not zero");
    }
    System.out.println("I'm happy with the input.");
} catch (InputMismatchException e) {
    System.out.println("Invalid Entry");
}
```

```

} catch (Exception e) {
    System.out.println("Error: " + e.getMessage());
} finally {
    System.out.println("Finally Clause Executed");
}

```

3. Why is the following code not a good use of the assertion?

```

public void compute(int size) {
    assert size > 0;
    //computation code comes here
}

```

4. Modify the following code by adding the assert statement. The value of gender is either MALE or FEMALE if the program is running correctly.

```

switch (gender) {
    case MALE:        totalFee = tuition + parkingFee;
                     break;
    case FEMALE:     totalFee = tuition + roomAndBoard;
                     break;
}

```

5. Modify the following method by adding the assert statement. Assume the variable factor is a data member of the class.

```

public double compute(double value) {
    return (value * value) / factor;
}

```

Level 1 Programming Exercises ★

6. When you run Ch8TestAgeInputVer4 and enter a negative number, you will get an error message: “Sorry, you do not qualify to enter the junior competition.” However, when a negative number is entered, it is more appropriate to say “Illegal value: negative age is invalid.” Modify the TestInputVer4 class so that an appropriate error message is displayed for a negative input value.
7. Modify the getInput method of the InputHandler class from Section 8.7 so that the method will throw an exception when a blank string (a sequence of one or more blank spaces) is entered for the name, room, or password. Define a new exception class EmptyInputException.
8. The user module of the keyless entry system in Section 8.7 does not include any logic to terminate the program. Modify the program so it will terminate when the values Admin, X123, and \$maTrix%TwO\$ are entered for name, room, and password, respectively.

Level 2 Programming Exercises ★★

9. Extend the Fraction class from Chapter 7 by incorporating exception handling and assertions.
10. Extend the Loan class from Chapter 4 Sample Development section by incorporating exception handling and assertions where appropriate. Adjust the LoanCalculator class accordingly to use the modified Loan class.

Development Exercises

For the following exercises, use the incremental development methodology to implement the program. For each exercise, identify the program tasks, create a design document with class descriptions, and draw the program diagram. Map out the development steps at the start. Present any design alternatives and justify your selection. Be sure to perform adequate testing at the end of each development step.

11. In the sample development, we developed the user module of the keyless entry system. For this exercise, implement the administrative module that allows the system administrator to add and delete Resident objects and modify information on existing Resident objects. The module will also allow the user to open a list from a file and save the list to a file. Is it proper to implement the administrative module by using one class? Wouldn't it be a better design if we used multiple classes with each class doing a single, well-defined task?
12. Write an application that maintains the membership lists of five social clubs in a dormitory. The five social clubs are the Computer Science Club, Biology Club, Billiard Club, No Sleep Club, and Wine Tasting Club. Use the Dorm class to manage the membership lists. Members of the social clubs are Resident objects of the dorm. Use a separate file to store the membership list for each club. Allow the user to add, delete, and modify members of each club.

9

Characters and Strings

O b j e c t i v e s

After you have read and studied this chapter, you should be able to

- Declare and manipulate data of the **char** type.
- Write string processing programs, using **String**, **StringBuilder**, and **StringBuffer** objects.
- Specify regular expressions for searching a pattern in a string.
- Differentiate the **String**, **StringBuilder**, and **StringBuffer** classes and use the correct class in solving a given task.
- Tell the difference between equality and equivalence testings for **String** objects.
- Use the **Pattern** and **Matcher** classes.

Introduction



E

arly computers in the 1940s and 1950s were more like gigantic calculators because they were used primarily for numerical computation. However, as computers have evolved to possess more computational power, our use of computers is no longer limited to numerical computation. Today we use computers for processing information of diverse types. In fact, most application software today such as Web browsers, word processors, database management systems, presentation software, and graphics design software is not intended specifically for number crunching. These programs still perform numerical computation, but their primary data are text, graphics, video, and other nonnumerical data. We have already seen examples of nonnumerical data processing. We introduced the `String` class and string processing in Chapter 2. A nonnumerical data type called `boolean` was used in Chapters 5 and 6. In this chapter, we will delve more deeply into the `String` class and present advanced string processing. We will also introduce the `char` data type for representing a single character and the `StringBuffer` class for an efficient operation on a certain type of string processing.

9.1 Characters

`char`

In Java single characters are represented by using the data type `char`. Character constants are written as symbols enclosed in single quotes, for example, `'a'`, `'X'`, and `'5'`. Just as we use different formats to represent integers and real numbers using 0s and 1s in computer memory, we use specific coding of 0s and 1s to represent single characters. For example, we may assign 1 to represent `'A'` and 2 to represent `'B'`. We can assign codes similarly to lowercase letters, punctuation marks, digits, and other special symbols. In the early days of computing, different computers used not only different coding schemes but also different character sets. For example, one computer could represent the symbol $\frac{1}{4}$, while other computers could not. Individualized coding schemes did not allow computers to share information. Documents created by using one scheme are complete gibberish if we try to read these documents by using another scheme. To avoid this problem, U.S. computer manufacturers devised several coding schemes. One of the coding schemes widely used today is *ASCII* (American Standard Code for Information Interchange). We pronounce ASCII “äs kē.” Table 9.1 shows the 128 standard ASCII codes.

ASCII

Adding the row and column indexes in Table 9.1 gives you the ASCII code for a given character. For example, the value 87 is the ASCII code for the character `'W'`. Not all characters in the table are printable. ASCII codes 0 through 31 and 127 are nonprintable control characters. For example, ASCII code 7 is the bell (the computer beeps when you send this character to output), and code 9 is the tab.

You Might Want to Know



When we use a word processor to create a document, the file that contains the document includes not only the contents but also the formatting information. Since each software company uses its own coding scheme for storing this information, we have to use the same word processor to open the document. Often it is even worse. We cannot open a document created by a newer version of the same word processor with an older version. If we just want to exchange the text of a document, then we can convert it to ASCII format. Any word processor can open and save ASCII files. If we would like to retain the formatting information also, we can convert the document, using software such as Adobe Acrobat. This software converts a document (including text, formatting, images, etc.) created by different word processors to a format called PDF. Anybody with a free Acrobat Reader can open a PDF file. Many of the documents available from our website are in this PDF format.

To represent all 128 ASCII codes, we need 7 bits ranging from 000 0000 (0) to 111 1111 (127). Although 7 bits is enough, ASCII codes occupy 1 byte (8 bits) because the byte is the smallest unit of memory you can access. Computer manufacturers use the extra bit for other nonstandard symbols (e.g., lines and boxes). Using 8 bits, we can represent 256 symbols in total—128 standard ASCII codes and 128 nonstandard symbols.

Table 9.1 ASCII codes

	0	1	2	3	4	5	6	7	8	9
0	nul	soh	stx	etx	eot	enq	ack	bel	bs	ht
10	lf	vt	ff	cr	so	si	dle	dc1	dc2	dc3
20	cd4	nak	syn	etb	can	em	sub	esc	fs	gs
30	rs	us	sp	!	"	#	\$	%	&	'
40	()	*	+	,	-	.	/	0	1
50	2	3	4	5	6	7	8	9	:	;
60	<	=	>	?	@	A	B	C	D	E
70	F	G	H	I	J	K	L	M	N	O
80	P	Q	R	S	T	U	V	W	X	Y
90	Z	[\]	^	_	`	a	b	c
100	d	e	f	g	h	i	j	k	l	m
110	n	o	p	q	r	s	t	u	v	w
120	x	y	z	{		}	~	del		

The standard ASCII codes work just fine as long as we are dealing with the English language because all letters and punctuation marks used in English are included in the ASCII codes. We cannot say the same for other languages. For languages such as French and German, the additional 128 codes may be used to represent character symbols not available in standard ASCII. But what about different currency symbols? What about non-European languages? Chinese, Japanese, and Korean all use different coding schemes to represent their character sets. Eight bits is not enough to represent thousands of ideographs.

Unicode

To accommodate the character symbols of non-English languages, the Unicode Consortium established the *Unicode Worldwide Character Standard*, commonly known simply as *Unicode*, to support the interchange, processing, and display of the written texts of diverse languages. The standard currently contains 34,168 distinct characters, which cover the major languages of the Americas, Europe, the Middle East, Africa, India, Asia, and Pacifica. To accommodate such a large number of distinct character symbols, Unicode characters occupy 2 bytes. Unicode codes for the character set shown in Table 9.1 are the same as ASCII codes.

Java, being a language for the Internet, uses the Unicode standard for representing `char` constants. Although Java uses the Unicode standard internally to store characters, to use foreign characters for input and output in our programs, the operating system and the development tool we use for Java programs must be capable of handling the foreign characters.

Characters are declared and used in a manner similar to data of other types. The declaration

```
char ch1, ch2 = 'X';
```

declares two `char` variables `ch1` and `ch2` with `ch2` initialized to 'X'. We can display the ASCII code of a character by converting it to an integer. For example, we can execute

```
System.out.println("ASCII code of character X is "
    + (int)'X' );
```

Conversely, we can see a character by converting its ASCII code to the `char` data type, for example,

```
System.out.println(
    "Character with ASCII code 88 is " + (char)88 );
```

Because the characters have numerical ASCII values, we can compare characters just as we compare integers and real numbers. For example, the comparison

```
'A' < 'c'
```

returns true because the ASCII value of 'A' is 65 while that of 'c' is 99.

Quick CHECK



- Determine the output of the following statements.
 - `System.out.println((char) 65);`
 - `System.out.println((int) 'C');`
 - `System.out.println('Y');`
 - `if ('A' < '?')`
`System.out.println('A');`
`else`
`System.out.println('?');`
- How many distinct characters can you represent by using 8 bits?

9.2 | Strings

String

A *string* is a sequence of characters that is treated as a single value. Instances of the **String** class are used to represent strings in Java. Rudimentary string processing was already presented in Chapter 2, using methods such as `substring`, `length`, and `indexOf`. In this section we will learn more advanced string processing, using other methods of the **String** class.

To introduce additional methods of the **String** class, we will go through a number of common string processing routines. The first is to process a string looking for a certain character or characters. Let's say we want to input a person's name and determine the number of vowels that the name contains. The basic idea is very simple:

```
for each character ch in the string {
    if (ch is a vowel) {
        increment the counter
    }
}
```

There are two details we need to know before being able to translate that into actual code. First, we need to know how to refer to an individual character in the string. Second, we need to know how to determine the size of the string, that is, the number of characters the string contains, so we can write the boolean expression to stop the loop correctly. We know from Chapter 2 that the second task is done by using the `length` method. For the first task, we use `charAt`.

charAt

We access individual characters of a string by calling the **charAt** method of the **String** object. For example, to display the individual characters of the string `Sumatra` one at a time, we can write

```
String name = "Sumatra";
int size = name.length();
for (int i = 0; i < size; i++) {
    System.out.println(name.charAt(i));
}
```

Each character in a string has an index that we use to access the character. We use zero-based indexing; that is, the first character has index 0, the second character

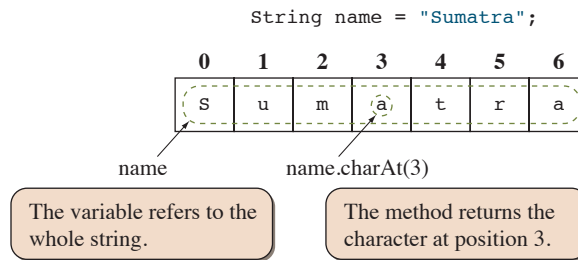

Figure 9.1 An indexed expression is used to refer to individual characters in a string.

has index 1, the third character has index 2, and so forth. To refer to the first character of `name`, for example, we say

```
name.charAt(0)
```

Since the characters are indexed from 0 to `size-1`, we could express the preceding for loop as

```
for (int i = 0; i <= size - 1; i++)
```

However, we will use the first style almost exclusively to be consistent.

Figure 9.1 illustrates how the `charAt` method works. Notice that `name` refers to a `String` object, and we are calling its `charAt` method that returns a value of primitive data type `char`. Strictly speaking, we must say “`name` is a variable of type `String` whose value is a reference to an instance of `String`.” However, it is more common to say “`X` is an instance of `Y`” or “`X` is a `Y` object.” We often shorten it further to “`X` is a `Y`.”

Things to Remember



*If the value of a variable **X** is a reference to an object of class **Y**, then we say “**X** is a **Y** object” or “**X** is an instance of **Y**.” Frequently, we also say “**X** is a **Y**.”*

Since `String` is a class, we can create an instance of a class by using the `new` method. The statements we have been using so far, such as

```
String name1 = "Kona";
String name2;
name2 = "Espresso";
```

work as a shorthand for

```
String name1 = new String("Kona");
String name2;
name2 = new String("Espresso");
```

Be aware that this shorthand works for the `String` class only. Moreover, although the difference will not be critical in almost all situations, they are not exactly the same. We will discuss the subtle difference between the two in Section 9.5.

Here is the code for counting the number of vowels:

```

/*
Chapter 9 Sample Program: Count the number of vowels
in a given string

File: Ch9CountVowels.java
*/
import java.util.*;

class Ch9CountVowels {

    public static void main (String[] args) {

        Scanner scanner = new Scanner(System.in);
        scanner.useDelimiter(System.getProperty("line.separator"));

        String name;

        int    numberOfCharacters,
              vowelCount = 0;

        char   letter;

        System.out.print("What is your name?");
        name = scanner.next( );

        numberOfCharacters = name.length( );

        for (int i = 0; i < numberOfCharacters; i++) {
            letter = name.charAt(i);

            if (letter == 'a' || letter == 'A' ||
                letter == 'e' || letter == 'E' ||
                letter == 'i' || letter == 'I' ||
                letter == 'o' || letter == 'O' ||
                letter == 'u' || letter == 'U' ) {
                vowelCount++;
            }
        }

        System.out.println(name + ", your name has " +
                           vowelCount + " vowels");
    }
}

```

We can shorten the boolean expression in the if statement by using the `toUpperCase` method of the `String` class. This method converts every character in a string to uppercase. Here's the rewritten code:

```

/*
Chapter 9 Sample Program: Count the number of vowels
in a given string using toUpperCase

File: Ch9CountVowels2.java
*/

import java.util.*;

class Ch9CountVowels2 {

    public static void main (String[] args) {

        Scanner scanner = new Scanner(System.in);
        scanner.useDelimiter(System.getProperty("line.separator"));

        String    name, nameUpper;

        int        numberOfCharacters,
                  vowelCount = 0;

        char        letter;

        System.out.print("What is your name?");
        name = scanner.next( );

        numberOfCharacters = name.length( );
        nameUpper = name.toUpperCase( );

        for (int i = 0; i < numberOfCharacters; i++) {

            letter = nameUpper.charAt(i);

            if (letter == 'A' ||
                letter == 'E' ||
                letter == 'I' ||
                letter == 'O' ||
                letter == 'U' ) {

                vowelCount++;

            }

        }

        (name + ", your name has " +
        vowelCount + " vowels");

    }
}

```

toUpperCase

Notice that the original string name is unchanged. A new, converted string is returned from the `toUpperCase` method and assigned to the second String variable `nameUpper`.

Let's try another example. This time we read in a string and count how many words the string contains. For this example we consider a word as a sequence of characters separated, or delimited, by blank spaces. We treat punctuation marks and other symbols as part of a word. Expressing the task in pseudocode, we have the following:

```
read in a sentence;
while (there are more characters in the sentence) {
    look for the beginning of the next word;
    now look for the end of this word;
    increment the word counter;
}
```

We use a while loop here instead of do-while to handle the case when the input sentence contains no characters, that is, when it is an empty string. Let's implement the routine. Here's our first attempt:

```
//Attempt No. 1
static final char BLANK = ' ';

Scanner scanner = new Scanner(System.in);
scanner.useDelimiter(System.getProperty("line.separator"));

int    index, wordCount, numberOfCharacters;

System.out.println("Enter a sentence: ");
String sentence = scanner.next();

numberOfCharacters = sentence.length();
index              = 0;
wordCount          = 0;

while (index < numberOfCharacters) {

    //ignore blank spaces
    while (sentence.charAt(index) == BLANK) {
        index++;
    }

    //now locate the end of the word
    while (sentence.charAt(index) != BLANK) {
        index++;
    }

    //another word has been found, so increment the counter
    wordCount++;
}
}
```

Skip blank spaces until a character that is not a blank space is encountered. This is the beginning of a word.

Once the beginning of a word is detected, we skip nonblank characters until a blank space is encountered. This is the end of the word.

This implementation has a problem. The counter variable `index` is incremented inside the two inner while loops, and this index could become equal to `numberOfCharacters`, which is an error, because the position of the last character is `numberOfCharacters - 1`. We need to modify the two while loops so that `index` will not become larger than `numberOfCharacters - 1`. Here's the modified code:

```

/*
Chapter 9 Sample Program: Count the number of words
                        in a given string

File: Ch9CountWords.java (Attempt 2)
*/
import java.util.*;

class Ch9CountWords { //Attempt 2
    private static final char BLANK = ' ';

    public static void main (String[] args) {

        Scanner scanner = new Scanner(System.in);
        scanner.useDelimiter(System.getProperty("line.separator "));

        int    index, wordCount, numberOfCharacters;

        System.out.println("Enter a sentence: ");
        String sentence = scanner.next( );

        numberOfCharacters = sentence.length( );
        index              = 0;
        wordCount          = 0;

        while ( index < numberOfCharacters ) {

            //ignore blank spaces
            while (index < numberOfCharacters &&
                sentence.charAt(index) == BLANK) {

                index++;
            }

            //now locate the end of the word
            while (index < numberOfCharacters &&
                sentence.charAt(index) != BLANK) {

                index++;
            }

            //another word is found, so increment the counter
            wordCount++;

        }
    }
}

```

```

//display the result
System.out.println( "\n input sentence: " + sentence );
System.out.println( "          Word count: " + wordCount + " words" );
    }
}

```

Notice that the order of comparisons in the boolean expression

```

index < numberOfCharacters
    && sentence.charAt(index) == BLANK

```

is critical. If we switch the order to

```

sentence.charAt(index) == BLANK
    && index < numberOfCharacters

```

out-of-bound
exception

and if the last character in the string is a space, then an *out-of-bound exception* will occur because the value of `index` is a position that does not exist in the string `sentence`. By putting the expression correctly as

```

index < numberOfCharacters && sentence.charAt(index) != ' '

```

we will not get an out-of-bound exception because the boolean operator `&&` is a shortcircuit operator. If the relation `index < numberOfCharacters` is false, then the second half of the expression `sentence.charAt(index) != BLANK` will not get evaluated.

There is still a problem with the attempt 2 code. If the sentence ends with one or more blank spaces, then the value for `wordCount` will be 1 more than the actual number of words in the sentence. It is left as an exercise to correct this bug (see Exercise 15 at the end of the chapter).

Our third example counts the number of times the word `Java` occurs in the input. The repetition stops when the word `STOP` is read. Lowercase and uppercase letters are not distinguished when an input word is compared to `Java`, but the word `STOP` for terminating the loop must be in all uppercase letters. Here's the pseudocode:

```

javaCount = 0;
while (true) {
    read in next word;
    if (word is "STOP") {
        break;
    }
}

```

```

        } else if (word is "Java" ignoring cases) {
            javaCount++;
        }
    }
}

```

And here's the actual code. Pay close attention to how the strings are compared.

```

/*
Chapter 9 Sample Program:

Count the number of times the word 'java' occurs
in input. Case-insensitive comparison is used here.
The program terminates when the word STOP (case-sensitive)
is entered.

File: Ch9CountJava.java
*/

import java.util.*;

class Ch9CountJava {

    public static void main (String[] args) {

        Scanner scanner = new Scanner(System.in);

        int    javaCount = 0;

        String word;

        while (true) {

            System.out.print("Next word: ");
            word = scanner.next( );

            if (word.equals("STOP") ) {
                break;
            } else if (word.equalsIgnoreCase("Java") ) {
                javaCount++;
            }
        }

        System.out.println("'Java' count: " + javaCount );
    }
}

```

compareTo

String comparison is done by two methods—`equals` and `equalsIgnoreCase`—whose meanings should be clear from the example. Another comparison method is `compareTo`. This method compares two `String` objects `str1` and `str2` as in

```
str1.compareTo( str2 );
```

and returns 0 if they are equal, a negative integer if `str1` is less than `str2`, and a positive integer if `str1` is greater than `str2`. The comparison is based on the lexicographic order of Unicode. For example, `caffeine` is less than `latte`. Also, the string `jaVa` is less than the string `java` because the Unicode value of `V` is smaller than the Unicode value of `v`. (See the ASCII table, Table 9.1.)

Some of you may be wondering why we don't say

```
if ( word == "STOP" )
```

We can, in fact, use the equality comparison symbol `==` to compare two `String` objects, but the result is different from the result of the method `equals`. We will explain the difference in Section 9.5.

Let's try another example, using the `substring` method we introduced in Chapter 2. To refresh our memory, here's how the method works. If `str` is a `String` object, then the expression

```
str.substring ( beginIndex, endIndex )
```

returns a new string that is a substring of `str` from position `beginIndex` to `endIndex - 1`. The value of `beginIndex` must be between 0 and `str.length() - 1`, and the value of `endIndex` must be between 0 and `str.length()`. In addition, the value of `beginIndex` must be less than or equal to the value of `endIndex`. Passing invalid values for `beginIndex` or `endIndex` will result in a runtime error.

In this example, we print out the words from a given sentence, using one line per word. For example, given an input sentence

```
I want to be a Java programmer
```

the code will print out

```
I
want
to
be
a
Java
programmer
```

This sample code is similar to the previous one that counts the number of words in a given sentence. Instead of just counting the words, we need to extract the word from the sentence and print it out. Here's how we write the code:

```

/*
Chapter 9 Sample Program:

    Extract the words in a given sentence and
    print them, using one line per word.

File: Ch9ExtractWords.java
*/

import java.util.*;

class Ch9ExtractWords {

    private static final char BLANK = ' ';

    public static void main (String[] args) {

        Scanner scanner = new Scanner(System.in);
        scanner.useDelimiter(System.getProperty("line.separator"));

        int index,    numberOfCharacters,
            beginIdx, endIdx;

        String word, sentence;
        System.out.print("Input: ");
        Sentence = scanner.next( );

        numberOfCharacters = sentence.length();
        index = 0;

        while (index < numberOfCharacters) {

            //ignore leading blank spaces
            while (index < numberOfCharacters &&
                sentence.charAt(index) == BLANK) {

                index++;
            }

            beginIdx = index;

            //now locate the end of the word
            while (index < numberOfCharacters &&
                sentence.charAt(index) != BLANK) {

                index++;
            }
        }
    }
}

```

```

endIdx = index;

if (beginIdx != endIdx) {

    //another word is found, extract it from the
    //sentence and print it out

    word = sentence.substring( beginIdx, endIdx );

    System.out.println(word);
}
}
}
}
}

```

Notice the significance of the test

```
if (beginIdx != endIdx)
```

in the code. For what kinds of input sentences will the variables `beginIdx` and `endIdx` be equal? We'll leave this as an exercise (see Exercise 16 at the end of the chapter).



1. Determine the output of the following code.

```

a. String str = "Programming";
   for (int i = 0; i < 9; i+=2) {
       System.out.print( str.charAt( i ) );
   }

b. String str = "World Wide Web";
   for (int i = 0; i < 10; i ++ ) {
       if ( str.charAt(i) == 'W' ) {
           System.out.println( 'M' );
       } else {
           System.out.print( str.charAt(i) );
       }
   }

```

2. Write a loop that prints out a string in reverse. If the string is Hello, then the code outputs olleH.

3. Assume two `String` objects `str1` and `str2` are initialized as follows:

```
String str1 = "programming";
String str2 = "language";
```

Determine the value of each of the following expressions if they are valid. If they are not valid, state the reason why.

- a. `str1.compareTo(str2)`
 - b. `str2.compareTo(str2)`
 - c. `str2.substring(1, 1)`
 - d. `str2.substring(0, 7)`
 - e. `str2.charAt(11)`
 - f. `str1.length() + str2.length()`
4. What is the difference between the two `String` methods `equals` and `equalsIgnoreCase`?

9.3 Pattern Matching and Regular Expression

One sample code from Section 9.2 searched for the word `Java` in a given string. This sample code illustrated a very simplified version of a well-known problem called *pattern matching*. Word processor features such as finding a text and replacing a text with another text are two specialized cases of a pattern-matching problem.

pattern
matching

The `matches` Method

Let's begin with the `matches` method from the `String` class. In its simplest form, it looks very similar to the `equals` method. For example, given a string `str`, the two statements

```
str.equals("Hello");
str.matches("Hello");
```

both evaluate to `true` if `str` is the string `Hello`. However, they are not truly equivalent, because, unlike `equals`, the argument to the `matches` method can be a pattern, a feature that brings great flexibility and power to the `matches` method.

Suppose we assign a three-digit code to all incoming students. The first digit represents the major, and 5 stands for the computer science major. The second digit represents the home state: 1 is for in-state students, 2 is for out-of-state students, and 3 is for foreign students. And the third digit represents the residence of the student. On-campus dormitories are represented by digits from 1 through 7. Students living off campus are represented by digit 8. For example, the valid encodings for students majoring in computer science and living off campus are 518, 528, and 538. The valid three-digit code for computer science majors living in one of the on-campus dormitories can be expressed succinctly as

```
5[123][1-7]
```

and here's how we interpret the pattern:

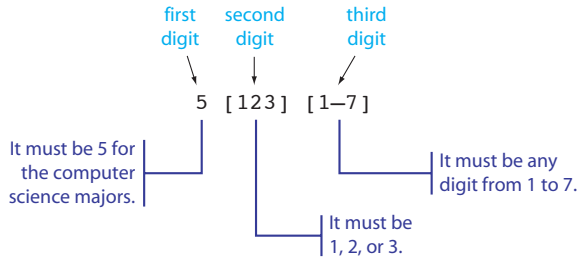

regular
expression

The pattern is called a *regular expression* that allows us to denote a large (often infinite) set of words succinctly. The “word” is composed of any sequence of symbols and is not limited to alphabets. The brackets [] are used here to represent choices, so [123] means 1, 2, or 3. We can use the notation for alphabets also. For example, [aBc] means a, B, or c. Notice the notation is case-sensitive. The hyphen in the brackets shows the range, so [1-7] means any digit from 1 to 7. If we want to allow any lowercase letter, then the regular expression will be [a-z]. The hat symbol ^ is used for negation. For example, [^abc] means any character except a, b, or c. Notice that this expression does not restrict the character to lowercase letters; it can be any character including digits and symbols. To refer to all lowercase letters except a, b, or c, the correct expression is [a-z&&[^abc]]. The double ampersand represents an intersection. Here are more examples:

Expression	Description
[013]	A single digit 0, 1, or 3.
[0-9] [0-9]	Any two-digit number from 00 to 99.
A [0-4] b [05]	A string that consists of four characters. The first character is A. The second character is 0, 1, 2, 3, or 4. The third character is b. And the last character is either 0 or 5.
[0-9&& [^4567]]	A single digit that is 0, 1, 2, 3, 8, or 9.
[a-z0-9]	A single character that is either a lowercase letter or a digit.

We can use repetition symbols * or + to designate a sequence of unbounded length. The symbol * means 0 or more times, and the symbol + means 1 or more times. Let's try an example using a repetition symbol. Remember the definition for a valid Java identifier? We define it as a sequence of alphanumeric characters, underscores, and dollar signs, with the first character being an alphabet. In regular expression, we can state this definition as

[a-zA-Z] [a-zA-Z0-9_ \$] *

Let's write a short program that will input a word and determine whether it is a valid Java identifier. The program stops when the word entered is STOP. Here's the program:

```

/*
Chapter 9 Sample Program: Checks whether the input
string is a valid identifier.

File: Ch9MatchJavaIdentifier.java
*/

import java.util.*;

class Ch9MatchJavaIdentifier {

    private static final String STOP    = "STOP";
    private static final String VALID   = "Valid Java identifier";
    private static final String INVALID = "Not a valid Java identifier";

    private static final String VALID_IDENTIFIER_PATTERN
        = "[a-zA-Z][a-zA-Z0-9_]*";

    public static void main (String[] args) {

        Scanner scanner = new Scanner (System.in);

        String str, reply;

        while (true) {

            System.out.print ("Identifier: ");
            str = scanner.next( );

            if (str.equals(STOP)) break;

            if (str.matches(VALID_IDENTIFIER_PATTERN)) {
                reply = VALID;
            } else {
                reply = INVALID;
            }

            System.out.println(str + ": " + reply + "\n");
        }
    }
}

```

It is also possible to designate a sequence of fixed length. For example, to specify four-digit numbers, we write `[0-9]{4}`. The number in the braces `{` and `}` denotes the number of repetitions. We can specify the minimum and maximum numbers of

repetitions also. Here are the rules:

Expression	Description
X{N}	Repeat X exactly N times, where X is a regular expression for a single character.
X{N,}	Repeat X at least N times.
X{N,M}	Repeat X at least N but no more than M times.

Here's an example of using a sequence of fixed length. Suppose we want to determine whether the input string represents a valid phone number that follows the pattern of

xxx-xxx-xxxx

where x is a single digit from 0 through 9. The following is a program that inputs a string continually and replies whether the input string conforms to the pattern. The program terminates when a single digit 0 is entered. Structurally this program is identical to the Ch9MatchJavaIdentifier class. Here's the program:

```

/*
Chapter 9 Sample Program: Checks whether the input
string conforms to the phone number
pattern xxx-xxx-xxxx.

File: Ch9MatchPhoneNumber.java
*/
import java.util.*;

class Ch9MatchPhoneNumber {

    private static final String STOP      = "0";
    private static final String VALID     = "Valid phone number";
    private static final String INVALID   = "Not a valid phone number";

    private static final String VALID_PHONE_PATTERN
        = "[0-9]{3}-[0-9]{3}-[0-9]{4}";

    public static void main (String[] args) {

        Scanner scanner = new Scanner (System.in);

        String phoneStr, reply;

        while (true) {

            System.out.print ("Phone#: ");
            phoneStr = scanner.next( );

```

```

    if (phoneStr.equals(STOP)) break;

    if (phoneStr.matches(VALID_PHONE_PATTERN)) {
        reply = VALID;
    } else {
        reply = INVALID;
    }

    System.out.println(phoneStr + ": " + reply + "\n");
}
}
}

```

Suppose, with the proliferation of cell phones, the number of digits used for a prefix increases from three to four in major cities. (In fact, Tokyo now uses a four-digit prefix. Phenomenal growth in the use of fax machines in both offices and homes caused the increase from three to four digits.) The valid format for phone numbers then becomes

xxx-xxx-xxxx or xxx-xxxx-xxxx

This change can be handled effortlessly by defining `VALID_PHONE_PATTERN` as

```

private static final String VALID_PHONE_PATTERN
    = "[0-9]{3}-[0-9]{3,4}-[0-9]{4}";

```

This is the power of regular expression and pattern-matching methods. All we need to do is to make one simple adjustment to the regular expression. No other changes are made to the program. Had we written the program without using the pattern-matching technique (i.e., written the program using repetition control to test the first to the last character individually), changing the code to handle both a three-digit and a four-digit prefix requires substantially greater effort.

The period symbol (`.`) is used to match any character except a line terminator such as `\n` or `\r`. (By using the `Pattern` class, we can make it match a line terminator also. We discuss more details on the `Pattern` class later.) We can use the period symbol with the zero-or-more-times notation `*` to check if a given string contains a sequence of characters we are looking for. For example, suppose a `String` object `document` holds the content of some document, and we want to check if the phrase “zen of objects” is in it. We can do it as follows:

```

String document;

document = ...; //assign text to 'document'

if (document.matches(".*zen of objects.*") {
    System.out.println("Found");
}

```

```

} else {
    System.out.println("Not found");
}

```

The brackets [and] are used for expressing a range of choices for a single character. If we need to express a range of choices for multiple characters, then we use the parentheses and the vertical bar. For example, if we search for the word *maximum* or *minimum*, we express the pattern as

```
(max|min)imum
```

Here are some more examples:

Expression	Description
[wb](ad eed)	Matches wad, weed, bad, and bead.
(pro anti)-oo?	Matches pro-ooP and anti-ooP.
(AZ CA CO)[0-9]{4}	Matches AZxxxx, CAxxxx, and COxxxx, where x is a single digit.

The replaceAll Method

Using the `replaceAll` method, we can replace all occurrences of a substring that matches a given regular expression with a given replacement string. For example, here's how to replace all vowels in the string with the @ symbol:

```

String originalText, modifiedText;
originalText = ...; //assign string to 'originalText'

modifiedText = originalText.replaceAll("[aeiou]", "@");

```

Notice the original text is unchanged. The `replaceAll` method returns a modified text as a separate string. Here are more examples:

Expression	Description
<code>str.replaceAll("OOP", "object-oriented programming")</code>	Replace all occurrences of OOP with object-oriented programming.
<code>str.replaceAll("[0-9]{3}-[0-9]{2}-[0-9]{4}", "xxx-xx-xxxx")</code>	Replace all social security numbers with xxx-xx-xxxx.
<code>str.replaceAll("o{2,}", "oo")</code>	Replace all occurrences of a sequence that has two or more of letter o with oo.

If we want to match only the whole word, we have to use the `\b` symbol to designate the word boundary. Suppose we write

```
str.replaceAll("temp", "temporary");
```

expecting to replace all occurrences of the abbreviated word `temp` by `temporary`. We will get a surprising result. All occurrences of the sequence of characters `temp` will be replaced; so, for example, words such as `attempt` or `tempting` would be replaced by `atemporaryt` or `temporaryting`, respectively. To designate the sequence `temp` as a whole word, we place the word boundary symbol `\b` in the front and end of the sequence.

```
str.replaceAll("\\btemp\\b", "temporary");
```

Notice the use of two backslashes. The symbol we use in the regular expression is `\b`. However, we must write this regular expression in a `String` representation. And remember that the backslash symbol in a string represents a control character such as `\n`, `\t`, and `\r`. To specify the regular expression symbol with a backslash, we must use additional backslash, so the system will not interpret it as some kind of control character. The regular expression we want here is

```
\btemp\b
```

To put it in a `String` representation, we write

```
"\\btemp\\b"
```

Here are the common backslash symbols used in regular expressions:

Expression	String Representation	Description
<code>\d</code>	<code>"\\d"</code>	A single digit. Equivalent to <code>[0–9]</code> .
<code>\D</code>	<code>"\\D"</code>	A single nondigit. Equivalent to <code>[^0–9]</code> .
<code>\s</code>	<code>"\\s"</code>	A white space character, such as space, tab, new line, etc.
<code>\S</code>	<code>"\\S"</code>	A non-white-space character.
<code>\w</code>	<code>"\\w"</code>	A word character. Equivalent to <code>[a-zA-Z_0–9]</code> .
<code>\W</code>	<code>"\\W"</code>	A nonword character.
<code>\b</code>	<code>"\\b"</code>	A word boundary (such as a white space and punctuation mark).
<code>\B</code>	<code>"\\B"</code>	A nonword boundary.

We also use the backslash if we want to search for a command character. For example, the plus symbol designates one or more repetitions. If we want to search for the plus symbol in the text, we use the backslash as `\+` and to express it as a

string, we write “\+”. Here’s an example. To replace all occurrences of C and C++ (not necessarily a whole word) with Java, we write

```
str.replaceAll("(C|C\\+\\+)", "Java");
```

Quick CHECK

1. Describe the string that the following regular expressions match.
 - a. `a*b`
 - b. `b[aiu]d`
 - c. `[Oo]bject(s|)`
2. Write a regular expression for a state vehicle license number whose format is a single capital letter, followed by three digits and four lowercase letters.
3. Which of the following regular expressions are invalid?
 - a. `(a-z)*+`
 - b. `[a|ab]xyz`
 - c. `abe-14`
 - d. `[a-z&&^a^b]`
 - e. `[//one]two`

9.4 | The Pattern and Matcher Classes

The `matches` and `replaceAll` methods of the `String` class are shorthand for using the `Pattern` and `Matcher` classes from the `java.util.regex` package. We will describe how to use these two classes for more efficient pattern matching.

The statement

```
str.matches(regex);
```

where `str` and `regex` are `String` objects is equivalent to

```
Pattern.matches(regex, str);
```

which in turn is equivalent to

```
Pattern pattern = Pattern.compile(regex);
Matcher matcher = pattern.matcher(str);
matcher.matches();
```

Similarly, the statement

```
str.replaceAll(regex, replacement);
```

where `replacement` is a replacement text is equivalent to

```
Pattern pattern = Pattern.compile(regex);
Matcher matcher = pattern.matcher(str);
matcher.replaceAll(replacement);
```

Explicit creation of `Pattern` and `Matcher` objects gives us more options and greater efficiency. We specify regular expressions as strings, but for the system to actually carry out the pattern-matching operation, the stated regular expression must first be converted to an internal format. This is done by the `compile` method of the `Pattern` class. When we use the `matches` method of the `String` or `Pattern` class, this conversion into the internal format is carried out every time the `matches` method is executed. So if we use the same pattern multiple times, then it is more efficient to convert just once, instead of repeating the same conversion, as was the case for the `Ch9MatchJavaIdentifier` and `Ch9MatchPhoneNumber` classes. The following is `Ch9MatchJavaIdentifierPM`, a more efficient version of `Ch9MatchJavaIdentifier`:

```

/*
   Chapter 9 Sample Program: Checks whether the input
   string is a valid identifier. This version
   uses the Matcher and Pattern classes.

   File: Ch9MatchJavaIdentifierPM.java
*/

import java.util.*;
import java.util.regex.*;

class Ch9MatchJavaIdentifierPM {

    private static final String STOP      = "STOP";
    private static final String VALID     = "Valid Java identifier";
    private static final String INVALID   = "Not a valid Java identifier";

    private static final String VALID_IDENTIFIER_PATTERN
        = "[a-zA-Z][a-zA-Z0-9_]*";

    public static void main (String[] args) {

        Scanner scanner = new Scanner(System.in);

        String str, reply;
        Matcher matcher;
        Pattern pattern
            = Pattern.compile(VALID_IDENTIFIER_PATTERN);

        while (true) {

            System.out.print("Identifier: ");
            str = scanner.next();

            if (str.equals(STOP)) break;

            matcher = pattern.matcher(str);

            if (matcher.matches()) {
                reply = VALID;
            }
        }
    }
}

```



```

System.out.println("Sentence: ");
document = scanner.next();

javaCount = 0;
matcher = pattern.matcher(document);

while (matcher.find()) {

    javaCount++;

}

System.out.println("The word 'java' occurred " +
                    javaCount + " times.");
}
}

```

When a matcher finds a matching sequence of characters, we can query the location of the sequence by using the `start` and `end` methods. The `start` method returns the position in the string where the first character of the pattern is found, and the `end` method returns the value 1 more than the position in the string where the last character of the pattern is found. Here's the code that prints out the matching sequences and their locations in the string when searching for the word `java` in a case-insensitive manner.

```

/*
Chapter 9 Sample Program:

    Displays the positions of the word 'java'
    in a given string using pattern-matching technique.

File: Ch9LocateJavaPM.java
*/

import javax.swing.*;
import java.util.regex.*;

class Ch9LocateJavaPM {

    public static void main (String[] args) {

        Scanner scanner = new Scanner(System.in);
        scanner.useDelimiter(System.getProperty("line.separator"));

        String document;

        Matcher matcher;
        Pattern pattern = Pattern.compile("java",
                                         Pattern.CASE_INSENSITIVE);
    }
}

```

```

System.out.println("Sentence: ");
document = scanner.next();

matcher = pattern.matcher(document);

while (matcher.find()) {
    System.out.println(document.substring(matcher.start(),
                                         matcher.end())
                      + " found at position "
                      + matcher.start());
}
}
}

```



1. Replace the following statements with the equivalent ones using the Pattern and Matcher classes.
 - a. `str.replaceAll("1", "one");`
 - b. `str.matches("alpha");`
2. Using the find method of the Matcher class, check if the given string document contains the whole word Java.

9.5 | Comparing Strings

We already discussed how objects are compared in Chapter 5. The same rule applies for the string, but we have to be careful in certain situations because of the difference in the way a new String object is created. First, we will review how the objects are compared. The difference between

```

String word1, word2;
...
if ( word1 == word2 ) ...

```

== versus
equals

and

```

if ( word1.equals(word2) ) ...

```

equivalence
test

is illustrated in Figure 9.2. The equality test `==` is true if the contents of variables are the same. For a primitive data type, the contents are values themselves; but for a reference data type, the contents are addresses. So for a reference data type, the equality test is true if both variables refer to the same object, because they both contain the same address. The `equals` method, on the other hand, is true if the String objects to which the two variables refer contain the same string value. To distinguish the two types of comparisons, we will use the term *equivalence test* for the `equals` method.

Case A: Referring to the same object.

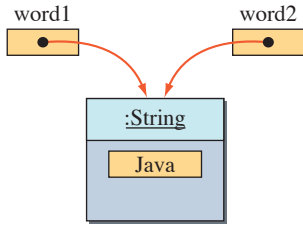

`word1 == word2` is **true**

`word1.equals(word2)` is **true**

Note: If `x == y` is **true**, then `x.equals(y)` is also **true**. The reverse is not always true.

Case B: Referring to different objects having identical string values.

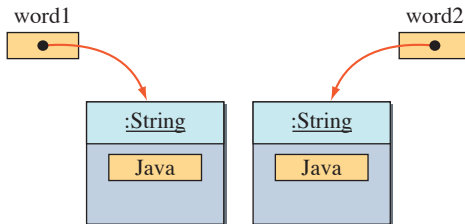

`word1 == word2` is **false**

`word1.equals(word2)` is **true**

Case C: Referring to different objects having different string values.

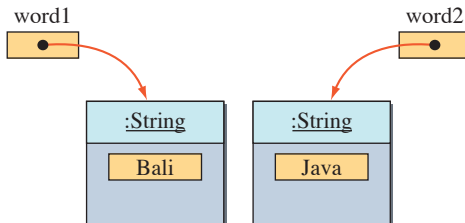

`word1 == word2` is **false**

`word1.equals(word2)` is **false**

Figure 9.2 The difference between the equality test and the **equals** method.

As long as we create a new String object as

```
String str = new String("Java");
```

using the new operator, the rule for comparing objects applies to comparing strings. However, when the new operator is not used, for example, in

```
String str = "Java";
```

we have to be careful. Figure 9.3 shows the difference in assigning a String object to a variable. If we do not use the new operator, then string data are treated as if they

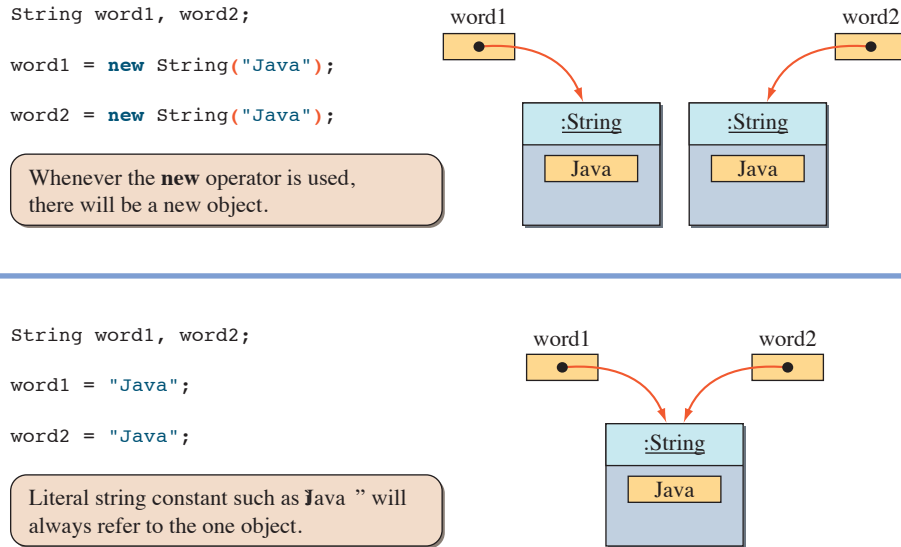

Figure 9.3 Difference between using and not using the **new** operator for **String**.

are primitive data type. When we use the same literal **String** constants in a program, there will be exactly one **String** object.



1. Show the state of memory after the following statements are executed.

```
String str1, str2, str3;
str1 = "Jasmine";
str2 = "Oolong";
str3 = str2;
str2 = str1;
```

9.6 | StringBuffer and StringBuilder

A **String** object is immutable, which means that once a **String** object is created, we cannot change it. In other words, we can read individual characters in a string, but we cannot add, delete, or modify characters of a **String** object. Remember that the methods of the **String** class, such as `replaceAll` and `substring`, do not modify the original string; they return a new string. Java adopts this immutability restriction to implement an efficient memory allocation scheme for managing **String** objects. The immutability is the reason why we can treat the string data much as a primitive data type.

string
manipulation

Creating a new string from the old one will work for most cases, but some times manipulating the content of a string directly is more convenient. When we need to compose a long string from a number of words, for example, being able to manipulate the content of a string directly is much more convenient than creating a new copy of a string. *String manipulation* here means operations such as replacing a character, appending a string with another string, deleting a portion of a string, and so forth. If we need to manipulate the content of a string directly, we must use either the `StringBuffer` or the `StringBuilder` class. Here's a simple example of modifying the string Java to Diva using a `StringBuffer` object:

```
StringBuffer word = new StringBuffer( "Java" );
word.setCharAt(0, 'D');
word.setCharAt(1, 'i');
```

Notice that no new string is created, the original string Java is modified. Also, we must use the new method to create a `StringBuffer` object.

The `StringBuffer` and `StringBuilder` classes behave exactly the same (i.e., they support the same set of public methods), but the `StringBuilder` class in general has a better performance. The `StringBuilder` class is new to Java 2 SDK version 1.5, so it cannot be used with the older versions of Java SDK. There are advanced cases where you have to use the `StringBuffer` class, but for the sample string processing programs in this book, we can use either one of them. Of course, to use the `StringBuilder` class, we must be using version 1.5 SDK. We can also continue to use the `StringBuffer` class with version 1.5.

Because the `StringBuffer` class can be used with all versions of Java SDK, and the string processing performance is not our major concern here, we will be using the `StringBuffer` class exclusively in this book. If the string processing performance is a concern, then all we have to do is to replace all occurrences of the word `StringBuffer` to `StringBuilder` in the program and run it with version 1.5 SDK.

StringBuffer

Let's look at some examples using `StringBuffer` objects. The first example reads a sentence and replaces all vowels in the sentence with the character X.

```
/*
Chapter 9 Sample Program: Replace every vowel in a given sentence
with 'X' using StringBuffer.

File: Ch9ReplaceVowelsWithX.java
*/
import java.util.*;

class Ch9ReplaceVowelsWithX {

    public static void main (String[] args) {

        Scanner scanner = new Scanner(System.in);
        scanner.useDelimiter(System.getProperty("line.separator"));
```

```

StringBuffer tempStringBuffer;
String      inSentence;

int         numberOfCharacters;
char        letter;

System.out.println("Sentence: ");
inSentence = scanner.next();

tempStringBuffer = new StringBuffer(inSentence);
numberOfCharacters = tempStringBuffer.length();

for (int index = 0; index < numberOfCharacters; index++) {
    letter = tempStringBuffer.charAt(index);

    if (letter == 'a' || letter == 'A' ||
        letter == 'e' || letter == 'E' ||
        letter == 'i' || letter == 'I' ||
        letter == 'o' || letter == 'O' ||
        letter == 'u' || letter == 'U' ) {
        tempStringBuffer.setCharAt(index, 'X');
    }
}

System.out.println("Input:  " + inSentence);
System.out.println("Output: " + tempStringBuffer);
}
}
}

```

Notice how the input routine is done. We are reading in a `String` object and converting it to a `StringBuffer` object, because we cannot simply assign a `String` object to a `StringBuffer` variable. For example, the following code is invalid:

```
StringBuffer strBuffer = scanner.next();
```

We are required to create a `StringBuffer` object from a `String` object as in

```
String      str      = "Hello";
StringBuffer strBuf = new StringBuffer( str );
```

Things to Remember



We cannot input **StringBuffer** objects. We have to input **String** objects and convert them to **StringBuffer** objects.

Our next example constructs a new sentence from input words that have an even number of letters. The program stops when the word STOP is read. Let's begin with the pseudocode:

```

    set tempStringBuffer to empty string;
    repeat = true;
    while ( repeat ) {
        read in next word;
        if (word is "STOP") {
            repeat = false;
        } else if (word has even number of letters) {
            append word to tempStringBuffer;
        }
    }

```

And here's the actual code:

```

/*
Chapter 9 Sample Program: Constructs a new sentence from
input words that have an even number of letters.

File: Ch9EvenLetterWords.java
*/
import javax.swing.*;

class Ch9EvenLetterWords {
    public static void main (String[] args) {
        Scanner scanner = new Scanner(System.in);
        boolean repeat = true;
        String word;
        StringBuffer tempStringBuffer = new StringBuffer("");
        while (repeat) {
            System.out.print("Next word: ");
            word = scanner.next( );
            if (word.equals("STOP")) {
                repeat = false;
            } else if (word.length() % 2 == 0) {
                tempStringBuffer.append(word + " ");
            }
        }
    }
}

```

Create **StringBuffer** object with an empty string.

Append **word** and a space to **tempStringBuffer**.

```

        System.out.println("Output: " + tempStringBuffer);
    }
}

```

We use the `append` method to append a `String` or a `StringBuffer` object to the end of a `StringBuffer` object. The method `append` also can take an argument of the primitive data type. For example, all the following statements are valid:

```

int    i    = 12;
float  x    = 12.4f;
char   ch   = 'W';

StringBuffer str = new StringBuffer("");

str.append(i);
str.append(x);
str.append(ch);

```

Any primitive data type argument is converted to a string before it is appended to a `StringBuffer` object.

Notice that we can write the second example using only `String` objects. Here's how:

```

boolean repeat = true;
String word, newSentence;

newSentence = ""; //empty string
while (repeat) {

    System.out.print("Next word: ");
    word = scanner.next();

    if (word.equals("STOP")) {
        repeat = false;
    } else if (word.length() % 2 == 0) {
        newSentence = newSentence + word;
        //string concatenation
    }
}

```

Although this code does not explicitly use any `StringBuffer` object, the Java compiler may use `StringBuffer` when compiling the string concatenation operator. For example, the expression

```
newSentence + word
```

can be compiled as if the expression were

```
new StringBuffer().append(word).toString()
```

Using the `append` method of `StringBuffer` is preferable to using the string concatenation operator `+` because we can avoid creating temporary string objects by using `StringBuffer`.

In addition to appending a string at the end of `StringBuffer`, we can insert a string at a specified position by using the `insert` method. The syntax for this method is

```
<StringBuffer> . insert ( <insertIndex>, <value> ) ;
```

where `<insertIndex>` must be greater than or equal to 0 and less than or equal to the length of `<StringBuffer>` and the `<value>` is an object or a value of the primitive data type. For example, to change the string

```
Java is great
```

to

```
Java is really great
```

we can execute

```
StringBuffer str = new StringBuffer("Java is great");
str.insert(8, "really ");
```



- Determine the value of `str` after the following statements are executed.
 - ```
StringBuffer str
 = new StringBuffer("Caffeine");
str.insert(0, "Dr. ");
```
  - ```
String str = "Caffeine";
StringBuffer str1 =
    new StringBuffer( str.substring(1, 3) );
str1.append('e');
str = "De" + str1;
```
 - ```
String str = "Caffeine";
StringBuffer str =
 new StringBuffer(str.substring(4, 8);
str1.insert (3, 'f');
str = "De" + str1
```
- Assume a `String` object `str` is assigned as a string value. Write a code segment to replace all occurrences of lowercase vowels in a given string to the letter `C` by using `String` and `StringBuffer` objects.
- Find the errors in the following code.

```
String str = "Caffeine";
StringBuffer str1 = str.substring(1, 3);
str1.append('e');
System.out(str1);
str1 = str1 + str;
```

## 9.7 | String Processing and Bioinformatics

Bioinformatics is a field of study that explores the use of computational techniques in solving biological problems. One of the well-known bioinformatics project is the Human Genome Project sponsored by the U.S. Department of Energy and the National Institutes of Health. The project was started in 1990 and concluded successfully in 2003, two years ahead of the schedule. One of the very challenging goals of the project was to identify all the genes in human body. The project has estimated that a human body contains 20,000–25,000 genes.

Genes are made of DNA (deoxyribonucleic acid), which is a sequence of molecules called *nucleotides* or *bases*. DNA contains genetic information used by the cell to produce proteins. Our bones, muscles, blood, and organs are all made of proteins. Our well-being, therefore, is determined by the cells functioning properly when creating proteins. DNA provides instructions to the cell, so it serves a role similar to a computer program. A cell is a computer that produces proteins (output) by reading instructions in DNA (program).

The genetic information in DNA is encoded as a sequence of four chemical bases—adenine (A), guanine (G), cytosine (C), and thymine (T). In contrast a computer program is a sequence of binary numbers 0 and 1. These four chemical bases are formed into *base pairs* by pairing A with T and G with C. Base pairs are arranged in two long strands (called *sugar phosphate backbone*) that form a spiral famously known as a *double helix*. Every cell (be it a nerve cell, skin cell, or muscle cell) contains the same DNA, and when a cell divides, the exact copy of DNA in the old cell is replicated in the new cell. What is amazing, ignoring the moral issues, is that, in theory, we can create a clone of a person from a single cell because the cell contains the DNA that encodes the complete genetic information of the person.

So what does computer programming, specifically string processing, have to do with DNA? DNA is encoded as a sequence of bases. This information can be represented as a string of four letters—A, T, G, and C, and common operations biologists perform on DNA sequences can be implemented as string processing programs. Let's look at some examples.

The first example is finding the GC-content of a given DNA sequence. The GC-content is simply the percentage of guanine (G) and cytosine (C) in the DNA sequence. If we let the expressions  $C_A$ ,  $C_G$ ,  $C_C$ , and  $C_T$  stand for the count of adenine, guanine, cytosine, and thymine, respectively, in the DNA sequence, then the GC-content is computed as follows:

$$\frac{C_G + C_C}{C_A + C_T + C_G + C_C} \times 100$$

Because any DNA sequence can contain only four types of bases, the length of string that represents a DNA sequence is equal to  $C_A + C_T + C_G + C_C$ . In other words, we only need to count the number of Gs and Cs. It's not necessary to count the number of As and Ts.

Here's the complete program. In the actual use, we would expect the DNA sequence (String) will be read from a file, as it will be quite long. Since we have not yet covered the file I/O, we will use a Scanner to input a DNA sequence.

```

/*
Chapter 9 Sample Program: Determine the GC-content of a given DNA sequence.
File: Ch9GCCContent.java
*/
import java.util.*;
class Ch9GCCContent {
 public static void main (String[] args) {
 Scanner scanner = new Scanner(System.in);
 String dna;
 int gcCount;
 int size;
 char base;
 double result;
 while (true) {
 System.out.print("Next DNA Sequence: ");
 dna = scanner.next();
 if (dna.equalsIgnoreCase("STOP")) {
 break;
 }
 size = dna.length();
 gcCount = 0;
 for (int i = 0; i < size; i++) {
 base = dna.charAt(i);
 if (base == 'G' || base == 'C') {
 gcCount++;
 }
 }
 result = gcCount * 100 / size;
 System.out.println("GC-Content:" + result + "%");
 System.out.println("");
 }
 }
}

```

In the next example, we will implement the transcription operation. DNA *transcription* is a process of synthesizing an RNA (ribonucleic acid), which is an intermediate step when creating proteins. Similar to DNA, RNA is composed of nucleotides. But unlike DNA, RNA is usually single-stranded and, instead of thymine, contains uracil (U). So, we transcribe a given DNA to an RNA by creating a new string that replaces Ts in the given DNA with Us. Here's the program:

```

/*
 Chapter 9 Sample Program: Transcribe DNA into RNA.
 File: Ch9TranscribedDNA.java
*/

import java.util.*;

class Ch9TranscribeDNA {

 public static void main (String[] args) {

 Scanner scanner = new Scanner(System.in);

 String dna;
 StringBuffer rna;

 int size;
 char base;

 while (true) {

 System.out.print("Next DNA Sequence: ");
 dna = scanner.next();

 if (dna.equalsIgnoreCase("STOP")) {
 break;
 }

 size = dna.length();
 rna = new StringBuffer();

 //scan through each letter and replace T with U
 for (int i = 0; i < size; i++) {

 base = dna.charAt(i);

 if (base == 'T') {
 base = 'U';
 }

 rna.append(base);
 }
 }
 }
}

```



```

 System.out.println("RNA:" + rna.toString());
 System.out.println("");
 }
}

```

We can use the pattern-matching approach here instead of the basic string processing approach shown in the program. The implementation of the pattern-matching approach is left as an exercise.

Let's try one more example. This time we output the reverse of a given DNA sequence. The program is actually very straightforward if we realize that the `StringBuffer` class includes the `reverse` method. (Note: You can, of course, implement the operation without using the `reverse` method.) Here's the program that uses the `reverse` method of the `StringBuffer` class:

```

/*
 Chapter 9 Sample Program: Output the reverse sequence of a given DNA.
 File: Ch9ReverseDNA.java
*/
import java.util.*;
class Ch9ReverseDNA {
 public static void main (String[] args) {
 Scanner scanner = new Scanner(System.in);
 String dna;
 StringBuffer result;
 while (true) {
 System.out.print("Next DNA Sequence: ");
 dna = scanner.next();
 if (dna.equalsIgnoreCase("STOP")) {
 break;
 }
 result = new StringBuffer(dna);
 result.reverse();
 System.out.println("RNA: " + result.toString());
 System.out.println("");
 }
 }
}

```

## 9.8 Sample Development

word concordance

### Building Word Concordance

One technique to analyze a historical document or literature is to track word occurrences. A basic form of **word concordance** is a list of all words in a document and the number of times each word appears in the document. Word concordance is useful in revealing the writing style of an author. For example, given a word concordance of a document, we can scan the list and count the numbers of nouns, verbs, prepositions, and so forth. If the ratios of these grammatical elements differ significantly between the two documents, there is a high probability that they are not written by the same person. Another application of word concordance is seen in the indexing of a document, which, for each word, lists the page numbers or line numbers where it appears in the document. In this sample development, we will build a word concordance of a given document, utilizing the string-processing technique we learned in this chapter.



One of the most popular search engine websites on the Internet today is Google ([www.google.com](http://www.google.com)). At the core of their innovative technology is a concordance of all Web pages on the Internet. Every month the company's Web crawler software visits 3 billion (and steadily growing) Web pages, and from these visits, a concordance is built. When the user enters a query, the Google servers search the concordance for a list of matching Web pages and return the list in the order of relevance.

### Problem Statement

*Write an application that will build a word concordance of a document. The output from the application is an alphabetical list of all words in the given document and the number of times they occur in the document. The documents are a text file (contents of the file are ASCII characters), and the output of the program is saved as an ASCII file also.*

### Overall Plan

As usual, let's begin the program development by first identifying the major tasks of the program. The first task is to get a text document from a designated file. We will use a helper class called **FileManager** to do this task. File processing techniques to implement the **FileManager** class will be presented in Chapter 12. The whole content of an ASCII file is represented in the program as a single **String** object. Using a pattern-matching technique, we extract individual words from the document. For each distinct word in the document, we associate a counter and increment it every time the word is repeated. We will use the second helper class called **WordList** for maintaining a word list. An entry in this list has two components—a word and how many times this word occurs in the

## 9.8 Sample Development—continued

document. A **WordList** object can handle an unbounded number of entries. Entries in the list are arranged in alphabetical order. We will learn how to implement the **WordList** class in Chapter 10.

We can express the program logic in pseudocode as

program  
tasks

```
while (the user wants to process another file) {
 Task 1: read the file;
 Task 2: build the word list;
 Task 3: save the word list to a file;
}
```

Let's look at the three tasks and determine objects that will be responsible for handling the tasks. For the first task, we will use the helper class **FileManager**. For the second task of building a word list, we will define the **Ch9WordConcordance** class, whose instance will use the **Pattern** and **Matcher** classes for word extraction, and another helper class **WordList** for maintaining the word list. The last task of saving the result is done by the **FileManager** class also.

Finally, we will define a top-level control object that manages all other objects. We will call this class **Ch9WordConcordanceMain**. This will be our instantiable main class. Here's our working design document:

program  
classes

| Design Document: Ch9WordConcordanceMain |                                                                                                                      |
|-----------------------------------------|----------------------------------------------------------------------------------------------------------------------|
| Class                                   | Purpose                                                                                                              |
| Ch9WordConcordanceMain                  | The instantiable main class of the program that implements the top-level program control.                            |
| Ch9WordConcordance                      | The key class of the program. An instance of this class manages other objects to build the word list.                |
| FileManager                             | A helper class for opening a file and saving the result to a file. Details of this class can be found in Chapter 12. |
| WordList                                | Another helper class for maintaining a word list. Details of this class can be found in Chapter 10.                  |
| Pattern/Matcher                         | Classes for pattern-matching operations.                                                                             |

Figure 9.4 is the working program diagram.

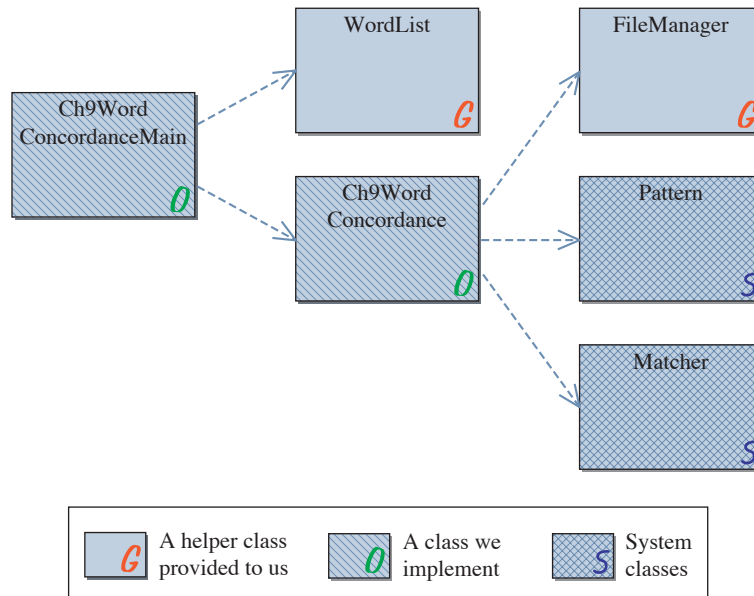

**Figure 9.4** The program diagram for the **Ch9WordConcordanceMain** program. Base system classes such as **String** and **JOptionPane** are not shown.



In lieu of the **Pattern** and **Matcher** classes, we could use the **String-Tokenizer** class. This class is fairly straightforward to use if the white space (tab, return, blank, etc.) is a word delimiter. However, using this class becomes a little more complicated if we need to include punctuation marks and others as a word delimiter also. Overall, the **Pattern** and **Matcher** classes are more powerful and useful in many types of applications than the **String-Tokenizer** class.

development  
steps

We will implement this program in four major steps:

1. Start with a program skeleton. Define the main class with data members. To test the main class, we will also define a skeleton **Ch9WordConcordance** class with just a default constructor.
2. Add code to open a file and save the result. Extend the step 1 classes as necessary.
3. Complete the implementation of the **Ch9WordConcordance** class.
4. Finalize the code by removing temporary statements and tying up loose ends.

## 9.8 Sample Development—continued

step 1  
design

## Step 1 Development: Skeleton

The design of **Ch9WordConcordanceMain** is straightforward, as its structure is very similar to that of other main classes. We will make this an instantiable main class and define the **start** method that implements the top-level control logic. We will define a default constructor to create instances of other classes. A skeleton **Ch9WordConcordance** class is also defined in this step so we can compile and run the main class. The skeleton **Ch9WordConcordance** class only has an empty default constructor. The working design document for the **Ch9WordConcordanceMain** class is as follows:

| Design Document: The Ch9WordConcordanceMain Class |                             |                                                                          |
|---------------------------------------------------|-----------------------------|--------------------------------------------------------------------------|
| <b>Method</b><br><constructor>                    | <b>Visibility</b><br>public | <b>Purpose</b><br>Creates the instances of other classes in the program. |
| start                                             | private                     | Implements the top-level control logic of the program.                   |

step 1 code

For the skeleton, the **start** method loops (doing nothing inside the loop in this step) until the user selects No on the confirmation dialog. Here's the skeleton:

```

/*
 Chapter 9 Sample Development: Word Concordance
 File: Step1/Ch9WordConcordanceMain.java
*/
import java.util.*;

class Ch9WordConcordanceMain {

 private static enum Response {YES, NO}

 private FileManager fileManager;
 private Ch9WordConcordance builder;
 private Scanner scanner;

 //-----
 // Main method
 //-----
 public static void main(String[] args) {
 Ch9WordConcordanceMain main = new Ch9WordConcordanceMain();
 main.start();
 }
}

```

```

public Ch9WordConcordanceMain() {
 fileManager = new FileManager();
 builder = new Ch9WordConcordance();
 scanner = new Scanner(System.in);
}

private void start() {
 Response userReply;
 while (true) {
 userReply = prompt("Run the program?");
 if (userReply == Response.NO) {
 break;
 }
 }
 System.out.println("Thank you for using the program. Good-Bye");
}

private Response prompt(String question) {
 String input;
 Response response = Response.NO;
 System.out.print(question + " (Yes - y; No - n): ");
 input = scanner.next();
 if (input.equals("Y") || input.equals("y")) {
 response = Response.YES;
 }
 return response;
}
}

```

The skeleton **Ch9WordConcordance** class has only an empty default constructor. Here's the skeleton class:

```

class Ch9WordConcordance {
 public Ch9WordConcordance() {
 }
}

```

## 9.8 Sample Development—continued

step 1 test

We run the program and verify that the constructor is executed correctly, and the repetition control in the **start** method works as expected.

**Step 2 Development: Open and Save Files**

step 2 design

In the second development step, we add routines to handle input and output. The tasks of opening and saving a file are delegated to the service class **FileManager**. We will learn the implementation details of the **FileManager** class in Chapter 12. Our responsibility right now is to use the class correctly. The class provides two key methods: one to open a file and another to save a file. So that we can create and view the content easily, the **FileManager** class deals only with text files. To open a text file, we call its **openFile** method. There are two versions. With the first version, we pass the filename. For example, the code

```
FileManager fm = new FileManager();
String doc = ...; //assign string data

fm.saveFile("output1.txt", doc);
```

will save the string data **doc** to a file named **output1.txt**. With the second version, we will let the end user select a file, using the standard file dialog. A sample file dialog is shown in Figure 9.5. With the second version, we pass only the string data to be saved as

```
fm.saveFile(doc);
```

When there's an error in saving a file, an **IOException** is thrown.

To open a text file, we use one of the two versions of the **openFile** method. The distinction is identical to the one for the **saveFile** methods. The first version requires the

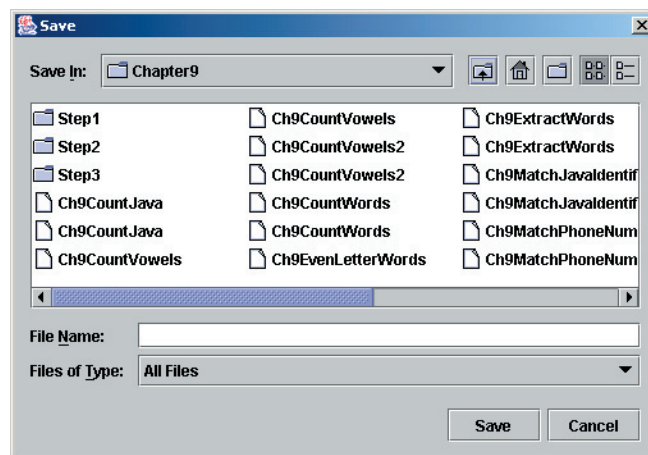

**Figure 9.5** A sample file dialog for opening a file.

filename to open. The second version allows the end user to select a file to save the data, so we pass no parameter. The **openFile** method will throw a **FileNotFoundException** when the designated file cannot be found and an **IOException** when the designated file cannot be opened correctly.

Here's the summary of the **FileManager** class:

| Public Methods of FileManager                                                                                           |                                                  |
|-------------------------------------------------------------------------------------------------------------------------|--------------------------------------------------|
| <b>public</b> String openFile(String filename)                                                                          | <b>throws</b> FileNotFoundException, IOException |
| Opens the text file filename and returns the content as a String.                                                       |                                                  |
| <b>public</b> String openFile( )                                                                                        | <b>throws</b> FileNotFoundException, IOException |
| Opens the text file selected by the end user, using the standard file open dialog, and returns the content as a String. |                                                  |
| <b>public</b> String saveFile(String filename, String data)                                                             | <b>throws</b> IOException                        |
| Save the string data to filename.                                                                                       |                                                  |
| <b>public</b> String saveFile(String data)                                                                              | <b>throws</b> IOException                        |
| Saves the string data to a file selected by the end user, using the standard file save dialog.                          |                                                  |

We modify the **start** method to open a file, create a word concordance, and then save the generated word concordance to a file. The method is defined as follows:

```
private void start() {
 Response userReply;
 String document, wordList;
 while (true) {
 userReply = prompt("Run the program?");
 if (userReply == Response.NO) {
 break;
 }
 document = inputFile(); //open file
 wordList = build(document); //build concordance
 saveFile(wordList); //save the generated concordance
 }
 ... //'Good-bye' message dialog
}
```

Added portion 



## 9.8 Sample Development—continued

The **inputFile** method is defined as follows:

```
private String inputFile() {
 String doc = "";

 try {
 doc = fileManager.openFile();
 } catch (FileNotFoundException e) {
 System.out.println("File not found.");
 } catch (IOException e) {
 System.out.println("Error in opening file: "
 + e.getMessage());
 }

 System.out.println("Input Document:\n" + doc); //TEMP
 return doc;
}
```

with a temporary output to verify the input routine. Because the **openFile** method of **FileManager** throws exceptions, we handle them here with the **try-catch** block.

The **saveFile** method is defined as follows:

```
private void saveFile(String list) {
 try {
 fileManager.saveFile(list);
 } catch (IOException e) {
 System.out.println("Error in saving file: "
 + e.getMessage());
 }
}
```

The method is very simple as the hard work of actually saving the text data is done by our **FileManager** helper object.

Finally, the **build** method is defined as

```
private String build(String document) {
 String concordance;

 concordance = builder.build(document);

 return concordance;
}
```

The **Ch9WordConcordanceMain** class is now complete. To run and test this class, we will define a stub **build** method for the **Ch9WordConcordance** class. The method is temporarily defined as

```
public String build(String document) {
 //TEMP
 String list
 = "one 14\ntwo 3\nthree 3\nfour 5\nfive 92\n";
 return list;
 //TEMP
}
```

We will implement the method fully in the next step.

Here's the final **Ch9WordConcordanceMain** class:

step 2 code

```
/*
 Chapter 9 Sample Development: Word Concordance
 File: Step2/Ch9WordConcordanceMain.java
*/
import java.io.*;
import java.util.*;

class Ch9WordConcordanceMain {
 ...
 private String build(String document) {
 String concordance;
 concordance = builder.build(document);
 return concordance;
 }
 private String inputFile() {
 String doc = "";

 try {
 doc = fileManager.openFile();
 } catch (FileNotFoundException e) {
 System.out.println("File not found.");
 } catch (IOException e) {
 System.out.println("Error in opening file: " + e.getMessage());
 }
 }
}
```

build

inputFile

## 9.8 Sample Development—continued

```

 System.out.println("Input Document:\n" + doc); //TEMP
 return doc;
 }

 private void saveFile(String list) {
 try {
 fileManager.saveFile(list);
 } catch (IOException e) {
 System.out.println("Error in saving file: " + e.getMessage());
 }
 }

 private void start() {
 while (true) {
 ...
 document = inputFile();

 wordList = build(document);

 saveFile(wordList);
 }
 ...
 }
}

```

saveFile

start

The temporary **Ch9WordConcordance** class now has the stub **build** method:

```

class Ch9WordConcordance {
 ...
 public String build(String document) {
 //TEMP
 String list = "one 14\ntwo 3\nthree 3\nfour 5\nfive 92\n";

 return list;
 //TEMP
 }
}

```

## step 2 test

We are ready to run the program. The step 2 directory contains several sample input files. We will open them and verify the file contents are read correctly by checking the temporary echo print output to **System.out**. To verify the output routine, we save to the output (the temporary output created by the **build** method of **Ch9WordConcordance**) and verify its content. Since the output is a text file, we can use any word processor or text editor to view its contents. (*Note:* If we use NotePad on the Windows platform to view the file, it may not appear correctly. See the box below on how to avoid this problem.)

Hints,  
& Tips,  
Pitfalls

The control characters used for a line separator are not the same for each platform (Windows, Mac, Unix, etc.). One platform may use `\n` for a line separator while another platform may use `\r\n` for a line separator. Even on the same platform, different software may not interpret the control characters in the same way. To make our Java code work correctly across all platforms, we do, for example,

```
String newline
 = System.getProperties().getProperty("line.separator");
String output = "line 1" + newline + "line 2" + newline;
```

instead of

```
String output = "line 1\nline 2\n";
```

### Step 3 Development: Generate Word Concordance

step 3  
design

In the third development step, we finish the program by implementing the **Ch9WordConcordance** class, specifically, its **build** method. Since we are using another helper class in this step, first we must find out how to use this helper class. The **WordList** class supports the maintenance of a word list. Every time we extract a new word from the document, we enter this word into a word list. If the word is already in the list, its count is incremented by 1. If the word occurs for the first time in the document, then the word is added to the list with its count initialized to 1. When we are done processing the document, we can get the word concordance from a **WordList** by calling its **getConcordance** method. The method returns the list as a single **String** with each line containing a word and its count in the following format:

```
2 Chapter
1 Early
1 However
2 In
1 already
1 also
1 an
```

## 9.8 Sample Development—continued

```

7 and
1 are
2 as
1 because

```

Because a single **WordList** object handles multiple documents, there's a method called **reset** to clear the word list before processing the next document. Here's the method summary:

| Public Methods of <b>WordList</b>                   |                                                                                                                                                                                                           |
|-----------------------------------------------------|-----------------------------------------------------------------------------------------------------------------------------------------------------------------------------------------------------------|
| <b>public void</b> <code>add(String word)</code>    | Increments the count for the given word. If the word is already in the list, its count is incremented by 1. If the word does not exist in the list, then it is added to the list with its count set to 1. |
| <b>public</b> <code>String getConcordance( )</code> | Returns the word concordance in alphabetical order of words as a single string. Each line consists of a word and its count.                                                                               |
| <b>public void</b> <code>reset( )</code>            | Clears the internal data structure so a new word list can be constructed. This method must be called every time before a new document is processed.                                                       |

The general idea behind the **build** method of the **Ch9WordConcordance** class is straightforward. We need to keep extracting a word from the document, and for every word found, we add it to the word list. Expressed in pseudocode, we have

```

while (document has more words) {
 word = next word in the document;
 wordList.add(word);
}
String concordance = wordList.getConcordance();

```

The most difficult part here is how to extract words from a document. We can write our own homemade routine to extract words, based on the technique presented in Section 9.2. However, this is too much work to get the task done. Writing a code that detects various kinds of word terminators (in addition to space, punctuation mark, control characters such as tab, new line, etc., all satisfy as the word terminator) is not that easy. Conceptually, it is not that hard, but it can be quite tedious to iron out all the details. Instead, we can use the pattern-matching technique provided by the **Pattern** and **Matcher** classes for a reliable and efficient solution.

The pattern for finding a word can be stated in a regular expression as

```
\w+
```

Putting it in a string format results in

```
"\\w+"
```

The **Pattern** and **Matcher** objects are thus created as

```
Pattern pattern = Pattern.compile("\\w+");
Matcher matcher = pattern.matcher(document);
```

and the control loop to find and extract words is

```
wordList.reset();
while (matcher.find()) {
 wordList.add(document.substring(matcher.start(),
 matcher.end()));
}
```

step 3 code

Here's the final **Ch9WordConcordance** class:

```
/*
Chapter 9 Sample Development: Word Concordance
File: Step3/Ch9WordConcordance.java
*/
import java.util.regex.*;
class Ch9WordConcordance {
 private static final String WORD = "\\w+";
 private WordList wordList;
 private Pattern pattern;
 public Ch9WordConcordance() {
 wordList = new WordList();
 pattern = Pattern.compile(WORD); //pattern is compiled only once
 }
 public String build(String document) {
 Matcher matcher = pattern.matcher(document);
 wordList.reset();
 while (matcher.find()){
 wordList.add(document.substring(matcher.start(),
 matcher.end()));
 }
 return wordList.getConcordance();
 }
}
```

build

## 9.8 Sample Development—*continued*

Notice how short the class is, thanks to the power of pattern matching and the helper **WordList** class.

### step 3 test

We run the program against varying types of input text files. We can use a long document such as the term paper for the last term's economy class (don't forget to save it as a text file before testing). We should also use some specially created files for testing purposes. One file may contain only one word repeated 7 times, for example. Another file may contain no words at all. We verify that the program works correctly for all types of input files.

### Step 4 Development: Finalize

### program review

As always, we finalize the program in the last step. We perform a critical review to find any inconsistency or error in the methods, any incomplete methods, places to add more comments, and so forth.

In addition, we may consider possible extensions. One is an integrated user interface where the end user can view both the input document files and the output word list files. Another is the generation of different types of list. In the sample development, we count the number of occurrences of each word. Instead, we can generate a list of positions where each word appears in the document. The **WordList** class itself needs to be modified for such extension.

## S u m m a r y

- The `char` data type represents a single character.
- The `char` constant is denoted by a single quotation mark, for example, `'a'`.
- The character coding scheme used widely today is ASCII (American Standard Code for Information Exchange).
- Java uses Unicode, which is capable of representing characters of diverse languages. ASCII is compatible with Unicode.
- A string is a sequence of characters, and in Java, strings are represented by `String` objects.
- The `Pattern` and `Matcher` classes are introduced in Java 2 SDK 1.4. They provide support for pattern-matching applications.
- Regular expression is used to represent a pattern to match (search) in a given text.
- The `String` objects are immutable. Once they are created, they cannot be changed.
- To manipulate mutable strings, use `StringBuffer`.

- Strings are objects in Java, and the rules for comparing objects apply when comparing strings.
- Only one String object is created for the same literal String constants.
- The standard classes described or used in this chapter are

|               |         |
|---------------|---------|
| String        | Pattern |
| StringBuffer  | Matcher |
| StringBuilder |         |

## Key Concepts

|                    |                    |
|--------------------|--------------------|
| characters         | pattern matching   |
| strings            | character encoding |
| string processing  | String comparison  |
| regular expression |                    |

## Chapter 9 Exercises

### Review Exercises

1. What is the difference between 'a' and "a"?
2. Discuss the difference between

```
str = str + word; //string concatenation
```

and

```
tempStringBuffer.append(word)
```

where str is a String object and tempStringBuffer is a StringBuffer object.

3. Show that if x and y are String objects and x == y is true, then x.equals(y) is also true, but the reverse is not necessarily true.
4. What will be the output from the following code?

```
StringBuffer word1, word2;
word1 = new StringBuffer("Lisa");
word2 = word1;
word2.insert(0, "Mona ");
System.out.println(word1);
```

5. Show the state of memory after the execution of each statement in the following code.

```
String word1, word2;
word1 = "Hello";
word2 = word1;
word1 = "Java";
```



6. Using a state-of-memory diagram, illustrate the difference between a null string and an empty string—a string that has no characters in it. Show the state-of-memory diagram for the following code. Variable `word1` is a null string, while `word2` is an empty string.

```
String word1, word2;
word1 = null;
word2 = "";
```

7. Draw a state-of-memory diagram for each of the following groups of statements.

|                                                                        |                                                                                 |
|------------------------------------------------------------------------|---------------------------------------------------------------------------------|
| <pre>String word1, word2; word1 = "French Roast"; word2 = word1;</pre> | <pre>String word1, word2; word1 = "French Roast"; word2 = "French Roast";</pre> |
|------------------------------------------------------------------------|---------------------------------------------------------------------------------|

8. The `Ch9ExtractWords` program for extracting words in a given sentence includes the test

```
if (beginIdx != endIdx) ...
```

Describe the type of input sentences that will result in the variables `beginIdx` and `endIdx` becoming equal.

### Level 1 Programming Exercises ★

9. Write a program that reads in a character and displays the character's ASCII. Accept the input as a string data and check the first character. Display an error message if more than one character is entered. Repeat the operation until the symbol `@` (ASCII 64) is entered.
10. Write a program that reads a sentence and prints out the sentence in reverse order using the reverse method of the `StringBuffer` class. For example, the method will display
- ```
?uoy era woH
```
- for the input
- ```
How are you?
```
- Repeat the operation until an empty string is entered.
11. Write a program that reads in a sentence and displays the count of individual vowels in the sentence. Use any output routine of your choice to display the result in this format. Count only the lowercase vowels. Repeat the operation until an empty string is entered.

```
Vowel counts for the sentence
 Mary had a little lamb.
of 'a' : 4
of 'e' : 1
of 'i' : 1
of 'o' : 0
of 'u' : 0
```

12. In the CH9TranscribeDNA program, we used the basic string processing approach. Rewrite the program by using the pattern-matching approach. Do not use the `replaceAll` method of the `String` class. Because we perform the transcription operation repeatedly, it is more efficient to use the `Pattern` and `Matcher` classes directly. Create an appropriate `Matcher` object before the while loop.

### Level 2 Programming Exercises ★★

13. Write a program that prints the number of uppercase letters in an input string. Use the class method `isUpperCase` of the `Character` class, which returns `true` if the passed parameter of type `char` is an uppercase letter. You need to explore the `Character` class from the `java.lang` package on your own. Repeat the operation until an empty string is entered.
14. Redo Exercise 13 without using the `Character` class. *Hint*: The ASCII of any uppercase letter will fall between 65 (code for 'A') and 90 (code for 'Z').
15. In the `Ch9ReverseDNA` program, we used the `reverse` method of the `StringBuffer` class to reverse a given DNA sequence (see also Exercise 10). Rewrite the `Ch9ReverseDNA` program without using the `reverse` method. You have to scan the input string and build a new (reversed) string.
16. Finding the complement of a given DNA strand is another common operation. The double helix of DNA is composed of two complementary strands. Because the base pairs are formed by pairing A with T and G with C, we can easily find the complement of a given DNA strand by simple substitutions. For example, the complement of `GATTCGATC` is `CTAAGCTAG`. Write a program that outputs the complement of a given DNA strand. Repeat the operation until an empty string is entered.
17. Write a program that outputs the reverse complement of a given DNA sequence. First you find the reverse of a given DNA sequence (see Exercise 15) and then output the complement (see Exercise 16) of the reversed sequence.
18. A codon is a triplet of nucleotides that specifies a single amino acids (a protein is a sequence of amino acids). Write a program that outputs codons given a DNA (or RNA) sequence. For example, if the input is `GATTCGATC`, the program outputs `GAT`, `TCG`, and `ATC`. Output one codon per line. If the length of an input string is not a multiple of 3, then ignore any leftover nucleotides. For example, if the input is `GATTCGA`, then output will be `GAT` and `TCG`. Repeat the operation until an empty string is entered.
19. Write a program that reads a sentence and prints out the sentence with all uppercase letters changed to lowercase and all lowercase letters changed to uppercase. Repeat the operation until an empty string is entered.
20. Write a program that transposes words in a given sentence. For example, given an input sentence

The gate to Java nirvana is near

the method outputs

```
ehT etag ot avaJ anavrin si raen
```

Repeat the operation until an empty string is entered. To simplify the problem, you may assume the input sentence contains no punctuation marks. You may also assume that the input sentence starts with a nonblank character and that there is exactly one blank space between the words.

21. Write a program that determines if an input word is a palindrome. A palindrome is a string that reads the same forward and backward, for example, *noon* and *madam*. Ignore the case of the letter. So, for example, *maDaM*, *MadAm*, and *mAdaM* are all palindromes. Repeat the operation until an empty string is entered.

### Level 3 Programming Exercises ★★★

22. Improve the program in Exercise 20 by removing the assumptions. For example, an input sentence could be

```
Hello, how are you? I use JDK 1.2.2. Bye-bye.
```

An input sentence may contain punctuation marks and more than one blank space between two words. Transposing the above will result in

```
olleH, woh era uoy? I esu KDJ 1.2.2. eyB-eyb.
```

Notice the position of punctuation marks does not change and only one blank space is inserted between the transposed words.

23. The `Ch9CountWords` program that counts the number of words in a given sentence has a bug. If the input sentence has one or more blank spaces at the end, the value for `wordCount` will be 1 more than the actual number of words in the sentence. Correct this bug in two ways: one with the `trim` method of the `String` class and another without using this method.
24. Write a program that determines if an input sentence is a palindrome, for example, *A man, a plan, a canal, Panama!* You ignore the punctuation marks, blanks, and case of the letters. Repeat the operation until an empty string is entered.

### Development Exercises

For the following exercises, use the incremental development methodology to implement the program. For each exercise, identify the program tasks, create a design document with class descriptions, and draw the program diagram. Map out the development steps at the start. Present any design alternatives and justify your selection. Be sure to perform adequate testing at the end of each development step.

25. Write an *Eggy-Peggy* program. Given a string, convert it to a new string by placing `egg` in front of every vowel. For example, the string

```
I Love Java
```

becomes

eggI Leegoveege Jeegaveega

26. Write a variation of the Eggy-Peggy program. Implement the following four variations:

- Sha            Add sha to the beginning of every word.
- Na             Add na to the end of every word.
- Sha Na Na    Add sha to the beginning and na na to the end of every word.
- Ava            Move the first letter to the end of the word and add ava to it.

Allow the user to select one of four possible variations.

27. Write a word guessing game. The game is played by two players, each taking a turn in guessing the secret word entered by the other player. Ask the first player to enter a secret word. After a secret word is entered, display a hint that consists of a row of dashes, one for each letter in the secret word. Then ask the second player to guess a letter in the secret word. If the letter is in the secret word, replace the dashes in the hint with the letter at all positions where this letter occurs in the word. If the letter does not appear in the word, the number of incorrect guesses is incremented by 1. The second player keeps guessing letters until either

- The player guesses all the letters in the word.        or
- The player makes 10 incorrect guesses.

Here's a sample interaction with blue indicating the letter entered by the player:

```

- - - -
S
- - - -
A
- A - A
V
- A V A
D
- A V A
J
J A V A
Bingo! You won.

```

Support the following features:

- Accept an input in either lowercase or uppercase.
- If the player enters something other than a single letter (a digit, special character, multiple letters, etc.), display an error message. The number of incorrect guesses is not incremented.
- If the player enters the same correct letter more than once, reply with the previous hint.

- Entering an incorrect letter the second time is counted as another wrong guess. For example, suppose the letter W is not in the secret word. Every time the player enters W as a guess, the number of incorrect guesses is incremented by 1.

After a game is over, switch the role of players and continue with another game. When it is the first player's turn to enter a secret word, give an option to the players to stop playing. Keep the tally and announce the winner at the end of the program. The tally will include for each player the number of wins and the total number of incorrect guesses made for all games. The player with more wins is the winner. In the case where both players have the same number of wins, the one with the lower number of total incorrect guesses is the winner. If the total numbers of incorrect guesses for both players are the same also, then it is a draw.

28. Write another word guessing game similar to the one described in Exercise 27. For this word game, instead of using a row of dashes for a secret word, a hint is provided by displaying the letters in the secret word in random order. For example, if the secret word is COMPUTER, then a possible hint is MPTUREOC. The player has only one chance to enter a guess. The player wins if he guessed the word correctly. Time how long the player took to guess the secret word. After a guess is entered, display whether the guess is correct or not. If correct, display the amount of time in minutes and seconds used by the player.

The tally will include for each player the number of wins and the total amount of time taken for guessing the secret words correctly (amount of time used for incorrect guesses is not tallied). The player with more wins is the winner. In the case where both players have the same number of wins, the one who used the lesser amount of time for correct guesses is the winner. If the total time used by both players is the same also, then it is a draw.

29. The word game Eggy-Peggy is an example of encryption. Encryption has been used since ancient times to communicate messages secretly. One of the many techniques used for encryption is called a *Caesar cipher*. With this technique, each character in the original message is shifted  $N$  positions. For example, if  $N = 1$ , then the message

I d r i n k o n l y d e c a f

becomes

J ! e s j o l ! p o m z ! e f d b g

The encrypted message is decrypted to the original message by shifting back every character  $N$  positions. Shifting  $N$  positions forward and backward is achieved by converting the character to ASCII and adding or subtracting  $N$ . Write an application that reads in the original text and the value for  $N$  and displays the encrypted text. Make sure the ASCII value resulting from

encryption falls between 32 and 126. For example, if you add 8 (value of  $N$ ) to 122 (ASCII code for 'z'), you should “wrap around” and get 35.

Write another application that reads the encrypted text and the value for  $N$  and displays the original text by using the Caesar cipher technique. Design a suitable user interface.

30. Another encryption technique is called a *Vignere cipher*. This technique is similar to a Caesar cipher in that a key is applied cyclically to the original message. For this exercise a key is composed of uppercase letters only. Encryption is done by adding the code values of the key's characters to the code values of the characters in the original message. Code values for the key characters are assigned as follows: 0 for A, 1 for B, 2 for C, . . . , and 25 for Z. Let's say the key is COFFEE and the original message is I drink only decaf. Encryption works as follows:

|   |   |   |   |   |   |   |   |   |   |   |   |   |   |   |   |   |   |
|---|---|---|---|---|---|---|---|---|---|---|---|---|---|---|---|---|---|
| I | d | r | i | n | k |   | o | n | l | y |   | d | e | c | a | f |   |
|   |   |   |   |   |   |   |   |   |   |   |   |   |   |   |   |   |   |
| + | + | + | + |   |   |   | . | . | . |   |   |   |   |   |   | + |   |
|   |   |   |   |   |   |   |   |   |   |   |   |   |   |   |   |   |   |
| C | O | F | F | E | E | C | O | F | F | E | E | C | O | F | F | E | E |
| ↓ | ↓ | ↓ | ↓ |   |   |   |   |   |   |   |   |   |   |   |   |   | ↓ |
| K | - | i | W |   |   |   | . | . | . |   |   |   |   |   |   |   | j |

Decryption reverses the process to generate the original message. Write an application that reads in a text and displays the encrypted text. Make sure the ASCII value resulting from encryption or decryption falls between 32 and 126. You can get the code for key characters by  $(\text{int}) \text{keyChar} - 65$ .

Write another application that reads the encrypted text and displays the original text, using the Vignere cipher technique.

31. A public-key cryptography allows anyone to encode messages while only people with a secret key can decipher them. In 1977, Ronald Rivest, Adi Shamir, and Leonard Adleman developed a form of public-key cryptography called the *RSA system*.

To encode a message using the RSA system, one needs  $n$  and  $e$ . The value  $n$  is a product of any two prime numbers  $p$  and  $q$ . The value  $e$  is any number less than  $n$  that cannot be evenly divided into  $y$  (that is,  $y \div e$  would have a remainder), where  $y = (p - 1) \times (q - 1)$ . The values  $n$  and  $e$  can be published in a newspaper or posted on the Internet, so anybody can encrypt messages. The original character is encoded to a numerical value  $c$  by using the formula

$$c = m^e \bmod n$$

where  $m$  is a numerical representation of the original character (for example, 1 for A, 2 for B, and so forth).

Now, to decode a message, one needs  $d$ . The value  $d$  is a number that satisfies the formula

$$e \cdot d \bmod y = 1$$

where  $e$  and  $y$  are the values defined in the encoding step. The original character  $m$  can be derived from the encrypted character  $c$  by using the formula

$$m = c^d \bmod n$$

Write a program that encodes and decodes messages using the RSA system. Use large prime numbers for  $p$  and  $q$  in computing the value for  $n$ , because when  $p$  and  $q$  are small, it is not that difficult to find the value of  $d$ . When  $p$  and  $q$  are very large, however, it becomes practically impossible to determine the value of  $d$ . Use the ASCII values as appropriate for the numerical representation of characters. Visit <http://www.rsasecurity.com> for more information on how the RSA system is applied in the real world.

# Arrays and Collections

# 10

## O b j e c t i v e s

---

*After you have read and studied this chapter, you should be able to*

- Manipulate a collection of data values, using an array.
- Declare and use an array of primitive data types in writing a program.
- Declare and use an array of objects in writing a program.
- Define a method that accepts an array as its parameter and a method that returns an array.
- Describe how a two-dimensional array is implemented as an array of arrays.
- Manipulate a collection of objects, using lists and maps.



## Introduction



# P

People collect all sorts of items from bottle caps to exotic cars. For proof, just go to eBay ([www.ebay.com](http://www.ebay.com)) and see millions and millions of collectibles up for auction. With computers, people amass intangible items such as music files. Exactly how many MP3 files do you have on your computer? Probably in the hundreds and you lost track of exactly how many. You may want to develop a custom software, so you can store the information you want in the format you like, to keep track of all MP3 files downloaded from the Web.

When we write a program to deal with a collection of items, say, 500 Student objects, 200 integers, 300 MP3 files, and so forth, simple variables will not work. It is just not practical or feasible to use 500 variables to process 500 Student objects. In theory, you can, but honestly, do you want to type in identifiers for 500 variables (student1, student2, . . .)? A feature supported by programming languages to manipulate a collection of values is an array.

In this chapter we will learn about Java arrays. We will learn the basics of array manipulation and how to use different types of arrays properly and effectively. In addition, we will study several collection classes from the `java.util` package that provide more advanced data management features not found in the basic Java arrays.

## 10.1 | Array Basics

Suppose we want to compute the annual average rainfall from 12 monthly averages. We can use three variables and compute the annual average as follows (in this and other code fragment examples, we assume `scanner` is a properly declared and created `Scanner` object):

```
double sum, rainfall, annualAverage;

sum = 0.0;

for (int i = 0; i < 12; i++) {
 System.out.print("Rainfall for month " + (i+1) + ": ");
 rainfall = scanner.nextDouble();

 sum += rainfall;
}

annualAverage = sum / 12.0;
```

Now suppose we want to compute the difference between the annual and monthly averages for every month and display a table with three columns, similar to the one shown in Figure 10.1.

| Annual Average Rainfall: 15.03 mm |         |           |
|-----------------------------------|---------|-----------|
| Month                             | Average | Variation |
| 1                                 | 13.3    | 1.73      |
| 2                                 | 14.9    | 0.13      |
| 3                                 | 14.7    | 0.33      |
| 4                                 | 23.0    | 7.97      |
| 5                                 | 25.8    | 10.77     |
| 6                                 | 27.7    | 12.67     |
| 7                                 | 12.3    | 2.73      |
| 8                                 | 10.0    | 5.03      |
| 9                                 | 9.8     | 5.23      |
| 10                                | 8.7     | 6.33      |
| 11                                | 8.0     | 7.03      |
| 12                                | 12.2    | 2.83      |

**Figure 10.1** Monthly rainfall figures and their variation from the annual average.

To compute the difference between the annual and monthly averages, we need to remember the 12 monthly rainfall averages. Without remembering the 12 monthly averages, we won't be able to derive the monthly variations after the annual average is computed. Instead of using 12 variables `januaryRainfall`, `februaryRainfall`, and so forth to solve this problem, we use an array.

array

An *array* is a collection of data values of the same type. For example, we may declare an array consisting of `double`, but not an array consisting of both `int` and `double`. The following declares an array of `double`:

```
double[] rainfall;
```

array  
declaration

The square brackets indicate the *array declaration*. The brackets may be attached to a variable instead of the data type. For example, the declaration

```
double rainfall[];
```

is equivalent to the previous declaration. In Java, an array is a reference data type. Unlike the primitive data type, the amount of memory allocated to store an array varies, depending on the number and type of values in the array. We use the `new` operator to allocate the memory to store the values in an array. Although we use the same reserved word `new` for the array memory allocation as for the creation of a new instance of a class, strictly speaking, an array is not an object.

### Things to Remember



*In Java, an array is a reference data type. We need to use the **new** operator to allocate the memory for an array.*

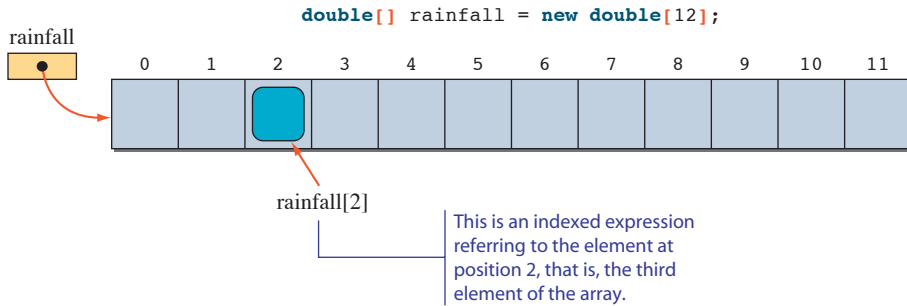

**Figure 10.2** An array of 12 **double** values.

The following statement allocates the memory to store 12 **double** values and associates the identifier `rainfall` to it.

```
rainfall = new double[12]; //create an array of size 12
```

Figure 10.2 shows this array.

We can also declare and allocate memory for an array in one statement, as in

```
double[] rainfall = new double[12];
```

indexed  
expression

array element

The number 12 designates the size of the array—the number of values the array contains. We use a single identifier to refer to the whole collection and use an *indexed expression* to refer to the individual values of the collection. An individual value in an array is called an *array element*. Zero-based indexing is used to indicate the positions of an element in the array. They are numbered 0, 1, 2, . . . , and `size - 1`, where `size` is the size of an array. For example, to refer to the third element of the `rainfall` array, we use the indexed expression

```
rainfall[2]
```

Instead of a literal constant such as 2, we can use an expression such as

```
rainfall[i+3]
```

Notice that the index for the first position in an array is zero. As for a `String` object, Java uses zero-based indexing for an array.

## Things to Remember



The index of the first position in an array is 0.

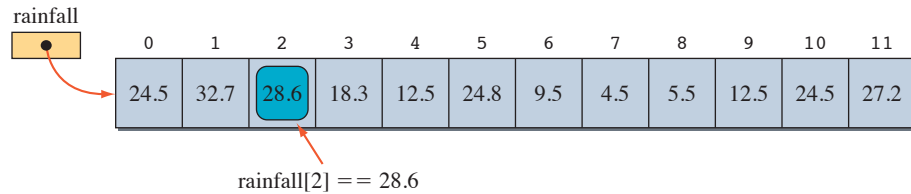

**Figure 10.3** An array of 12 **double** values after all 12 are assigned values.

Using the rainfall array, we can input 12 monthly averages and compute the annual average as

```
double[] rainfall = new double[12];
double annualAverage,
 sum = 0.0;

for (int i = 0; i < 12; i++) {

 System.out.print("Rainfall for month " + (i+1) + ": ");
 rainfall[i] = scanner.nextDouble();

 sum += rainfall[i];
}

annualAverage = sum / 12.0;
```

Can also be declared as  
**double** rainfall[]  
 = **new double**[12];

Figure 10.3 shows how the array will appear after all 12 values are entered.

After the 12 monthly averages are stored in the array, we can print out the table (alignment of the columns is not done here, but will be in the complete program listing).

```
double difference;

for (int i = 0; i < 12; i++) {
 System.out.print(i+1); //month #

 //average rainfall for the month
 System.out.print(" " + rainfall[i]);

 //difference between the monthly and annual averages
 difference = Math.abs(rainfall[i] - annualAverage);
 System.out.println(" " + difference);
}

}
```

Here's the complete program:

```
/*
Chapter 10 Sample Program: Compute the annual average rainfall
and the variation from monthly average.

File: Ch10Rainfall.java
*/
```

```

import java.util.*;

class Ch10Rainfall {

 public static void main (String[] args) {

 Scanner scanner = new Scanner (System.in);

 double[] rainfall = new double[12];

 double annualAverage,
 sum,
 difference;

 sum = 0.0;

 for (int i = 0; i < 12; i++) {

 System.out.print("Rainfall for month " + (i+1) + ": ");
 rainfall[i] = scanner.nextDouble();

 sum += rainfall[i];
 }

 annualAverage = sum / 12.0;

 System.out.format("Annual Average Rainfall:%5.2f\n\n",
 annualAverage);

 for (int i = 0; i < 12; i++) {

 System.out.format("%3d", i+1); //month #

 //average rainfall for the month
 System.out.format("%15.2f", rainfall[i]);

 //difference between the monthly and annual averages
 difference = Math.abs(rainfall[i] - annualAverage);
 System.out.format("%15.2f\n", difference);
 }
 }
}

```

Notice that the values displayed in the columns are aligned by formatting the string. An array has a public constant **length** for the size of an array. Using this constant, we can rewrite the for loop as

**length**

```

for (int i = 0; i < rainfall.length; i++) {
 ...
}

```

This for loop is more general since we do not have to modify the loop statement when the size of an array is changed. Also, the use of `length` is necessary when the size of an array is not known in advance. This happens, for example, when we write a method with an array as its parameter. We will provide an example of such a method in Section 10.3.

Notice the prompts for getting the values in the previous example are Rainfall for month 1, Rainfall for month 2, and so forth. A better prompt will spell out the month name, for example, Rainfall for January, Rainfall for February, and so forth. We can easily achieve a better prompt by using an array of strings. Here's how:

```
double[] rainfall = new double[12]; //an array of double
String[] monthName = new String[12]; //an array of String
double annualAverage,
 sum = 0.0;

monthName[0] = "January";
monthName[1] = "February";
monthName[2] = "March";
monthName[3] = "April";
monthName[4] = "May";
monthName[5] = "June";
monthName[6] = "July";
monthName[7] = "August";
monthName[8] = "September";
monthName[9] = "October";
monthName[10] = "November";
monthName[11] = "December";

for (int i = 0; i < rainfall.length; i++) {
 System.out.print("Rainfall for month" +
 monthName[i] + ": ");
 rainfall[i] = scanner.nextDouble();

 sum += rainfall[i];
}

annualAverage = sum / 12.0;
```

### Hints, & Tips, Pitfalls



It is very easy to mix up the **length** value of an array and the **length** method of a **String** object. The **length** is a method for a **String** object, so we use the syntax for calling a method.

```
String str = "This is a string";
int size = str.length();
```

But for an array, which is not an object but a reference data type, we do not use the syntax of method calling. We refer to the **length** value as

```
int size = rainfall.length;
```

Instead of assigning array elements individually, we can initialize the array at the time of declaration. We can, for example, initialize the `monthName` array by

No size is specified.

```
String[] monthName = { "January", "February", "March",
 "April", "May", "June", "July",
 "August", "September", "October",
 "November", "December" };
```

Notice that we do not specify the size of an array if the array elements are initialized at the time of declaration. The size of an array is determined by the number of values in the list. In the above example, there are 12 values in the list, so the size of the array `monthName` is set to 12.

Let's try some more examples. We assume the `rainfall` array is declared, and all 12 values are read in. The following code computes the average rainfall for the odd months (January, March, . . .) and the even months (February, April, . . .).

```
double oddMonthSum, oddMonthAverage,
 evenMonthSum, evenMonthAverage;

oddMonthSum = 0.0;
evenMonthSum = 0.0;

//compute the average for the odd months
for (int i = 0; i < rainfall.length; i += 2) {
 oddMonthSum += rainfall[i];
}
oddMonthAverage = oddMonthSum / 6.0;

//compute the average for the even months
for (int i = 1; i < rainfall.length; i += 2) {
 evenMonthSum += rainfall[i];
}
evenMonthAverage = evenMonthSum / 6.0;
```

We can compute the same result by using one for loop.

```
for (int i = 0; i < rainfall.length; i += 2) {
 oddMonthSum += rainfall[i];
 evenMonthSum += rainfall[i+1];
}

oddMonthAverage = oddMonthSum / 6.0;
evenMonthAverage = evenMonthSum / 6.0;
```

To compute the average for each quarter (quarter 1 has January, February, and March; quarter 2 has April, May, and June; and so forth), we can write

```
for (int i = 0; i < 3; i++) {
 quarter1Sum += rainfall[i];
 quarter2Sum += rainfall[i+3];
 quarter3Sum += rainfall[i+6];
 quarter4Sum += rainfall[i+9];
}
```

```

quarter1Average = quarter1Sum / 3.0;
quarter2Average = quarter2Sum / 3.0;
quarter3Average = quarter3Sum / 3.0;
quarter4Average = quarter4Sum / 3.0;

```

We can use another array to store the quarter averages instead of using four variables:

```

double[] quarterAverage = new double[4];

for (int i = 0; i < 4; i++) {
 sum = 0;

 for (int j = 0; j < 3; j++) { //compute the sum of
 sum += rainfall[3*i + j]; //one quarter
 }

 quarterAverage[i] = sum / 3.0; //average for quarter i+1
}

```

Notice how the inner for loop is used to compute the sum of one quarter. The following table illustrates how the values for the variables *i* and *j* and the expression  $3*i + j$  change.

| <i>i</i> | <i>j</i> | $3*i + j$ |
|----------|----------|-----------|
| 0        | 0        | 0         |
|          | 1        | 1         |
|          | 2        | 2         |
| 1        | 0        | 3         |
|          | 1        | 4         |
|          | 2        | 5         |
| 2        | 0        | 6         |
|          | 1        | 7         |
|          | 2        | 8         |
| 3        | 0        | 9         |
|          | 1        | 10        |
|          | 2        | 11        |

Here's the complete program:

```

/*
Chapter 10 Sample Program: Compute different statistics
from monthly rainfall averages.

File: Ch10RainfallStat.java
*/

```



```

import java.util.*;

class Ch10RainfallStat {

 public static void main(String[] args) {

 Scanner scanner = new Scanner(System.in);

 String[] monthName = { "January", "February", "March",
 "April", "May", "June", "July",
 "August", "September", "October",
 "November", "December" };

 double[] rainfall = new double[12];

 double[] quarterAverage = new double[4];

 double annualAverage,
 sum,
 difference;

 double oddMonthSum, oddMonthAverage,
 evenMonthSum, evenMonthAverage;

 sum = 0.0;

 for (int i = 0; i < rainfall.length; i++) {

 System.out.print("Rainfall for month " + monthName[i] + ": ");
 rainfall[i] = scanner.nextDouble();

 sum += rainfall[i];

 }

 annualAverage = sum / 12.0;

 System.out.format("Annual Average Rainfall:%6.2f\n\n",
 annualAverage);

 oddMonthSum = 0.0;
 evenMonthSum = 0.0;

 /////////////// Odd and Even Month Averages ///////////////////

 //compute the average for the odd months
 for (int i = 0; i < rainfall.length; i += 2) {

 oddMonthSum += rainfall[i];

 }

 oddMonthAverage = oddMonthSum / 6.0;

 //compute the average for the even months
 for (int i = 1; i < rainfall.length; i += 2) {

 evenMonthSum += rainfall[i];

 }
 }
}

```

```

evenMonthAverage = evenMonthSum / 6.0;

System.out.format("Odd Month Rainfall Average: %6.2f\n",
 oddMonthAverage);

System.out.format("Even Month Rainfall Average:%6.2f\n\n",
 evenMonthAverage);

////////// Quarter Averages //////////

for (int i = 0; i < 4; i++) {
 sum = 0;

 for (int j = 0; j < 3; j++) { //compute the sum of
 sum += rainfall[3*i + j]; //one quarter
 }

 quarterAverage[i] = sum / 3.0; //average for quarter i+1

 System.out.format("Rainfall Average Qtr.%3d:%6.2f\n",
 i+1, quarterAverage[i]);
}
}
}

```

In the previous examples, we used a constant to specify the size of an array, such as the literal constant 12 in the following declaration:

```
double[] rainfall = new double[12];
```

fixed-size array  
declaration

Using constants to declare array sizes does not always lead to efficient space usage. We call the declaration of arrays with constants a *fixed-size array declaration*. There are two potential problems with fixed-size array declarations. Suppose, for example, we declare an integer array of size 100:

```
int[] number = new int[100];
```

The first problem is that the program can process only up to 100 numbers. What if we need to process 101 numbers? We have to modify the program and compile it again. The second problem is a possible underutilization of space. The above declaration allocates 100 spaces whether they are used or not. Suppose the program on average processes 20 numbers. Then the program's average space usage is only 20 percent of the allocated space. With Java, we are not limited to fixed-size array declaration. We can declare an array of different size every time we run the

program. The following code prompts the user for the size of an array and declares an array of designated size:

```
int size;
int[] number;

System.out.print("Size of an array: ");
size = scanner.nextInt();

number = new int[size];
```

With this approach, every time the program is executed, only the needed amount of space is allocated for the array. Any valid integer arithmetic expression is allowed for size specification, for example,

```
System.out.print("Enter int: ");
size = scanner.nextInt();

number = new int[size*size + 2* size + 5];
```

variable-size  
array creation

We call the creation of arrays with nonconstant values a *variable-size array creation*. This capability comes very handy, for example, when an array runs out of space and we need to create a new, larger array. Suppose we start with an array of 20 elements. What would happen when we had to add the 21st element? We can create a new, larger array, say, twice as large as the original array. We then copy the values from the original array to the new array and finally add the 21st element to the new array. We will show you a concrete example of this scenario in Section 10.7.

Hints,  
& Tips,  
Pitfalls



Notice the first index position of an array is 0. Java adopted this feature from the programming language C. Using the zero-based indexing, the index value of an element indicates the number of elements in front of the element. For example, an index value of 0 for the first element indicates that there are zero elements in front of it; an index value of 4 for the fifth element indicates that there are four elements in front of it. Zero-based indexing allows a simpler formula to compute the actual memory address of array elements.

Quick  
CHECK  
✓

- Which of the following statements are invalid?
  - `float`    `number[23];`
  - `float`    `number = { 1.0f, 2.0f, 3.0f };`
  - `int`        `number;`  
              `number = new Array[23];`
  - `int[]`     `number = [ 1, 2, 3, 4 ];`

2. Write a code fragment to compute the sum of all positive real numbers stored in the following array.

```
double[] number = new double[25];
```

3. Describe the difference between the following two code fragments.

```
//code fragment 1
for (int i = 0; i < number.length; i++) {
 if (i % 2 == 0) {
 System.out.println(number[i]);
 }
}

//code fragment 2
for (int i = 0; i < number.length; i++) {
 if (number[i] % 2 == 0) {
 System.out.println(number[i]);
 }
}
```

## 10.2 Arrays of Objects

Array elements are not limited to primitive data types. Indeed, since a `String` is actually an object, we have already seen an example of an array of objects in Section 10.1. In this section we will explore arrays of objects in detail. To illustrate the processing of an array of objects, we will use the `Person` class in the following examples. We will define this `Person` class later in the chapter to introduce additional object-oriented concepts. Here's the portion of the `Person` class definition we will use in this section:

| Public Methods of the <code>Person</code> Class |                                                                                                                                                                                                                                                |
|-------------------------------------------------|------------------------------------------------------------------------------------------------------------------------------------------------------------------------------------------------------------------------------------------------|
| <code>public int</code>                         | <code>getAge ( )</code><br>Returns the age of a person. Default age of a person is set to 0.                                                                                                                                                   |
| <code>public char</code>                        | <code>getGender( )</code><br>Returns the gender of a person. The character <code>F</code> stands for female and <code>M</code> for male. Default gender of a person is set to the character <code>U</code> for unknown.                        |
| <code>public String</code>                      | <code>getName ( )</code><br>Returns the name of a person. Default name of a person is set to <code>Not Given</code> .                                                                                                                          |
| <code>public void</code>                        | <code>setAge ( int age )</code><br>Sets the age of a person.                                                                                                                                                                                   |
| <code>public void</code>                        | <code>setGender( char gender )</code><br>Sets the gender of a person to the argument <code>gender</code> . The character <code>F</code> stands for female and <code>M</code> for male. The character <code>U</code> designates unknown gender. |
| <code>public void</code>                        | <code>setName ( String name )</code><br>Sets the name of a person to the argument <code>name</code> .                                                                                                                                          |

The following code creates a `Person` object:

```
Person latte;

latte = new Person();
latte.setName("Ms. Latte");
latte.setAge(20);
latte.setGender('F');

System.out.println("Name: " + latte.getName());
System.out.println("Age : " + latte.getAge());
System.out.println("Sex : " + latte.getGender());
```

Now let's study how we can create and manipulate an array of `Person` objects. An array of objects is declared and created just as an array of primitive data types is. The following are a declaration and a creation of an array of `Person` objects.

```
Person[] person; //declare the person array
person = new Person[20]; //and then create it
```

Execution of the above code will result in a state shown in Figure 10.4.

Notice that the elements, that is, `Person` objects, are not yet created; only the array is created. Array elements are initially null. Since each individual element is an object, it also must be created. To create a `Person` object and set it as the array's first element, we write

```
person[0] = new Person();
```

Figure 10.5 shows the state after the first `Person` object is added to the array.

Notice that no data values are assigned to the object yet. The object has default values at this point. To assign data values to this object, we can execute

```
person[0].setName ("Ms. Latte");
person[0].setAge (20);
person[0].setGender('F');
```

The indexed expression

```
person[0]
```

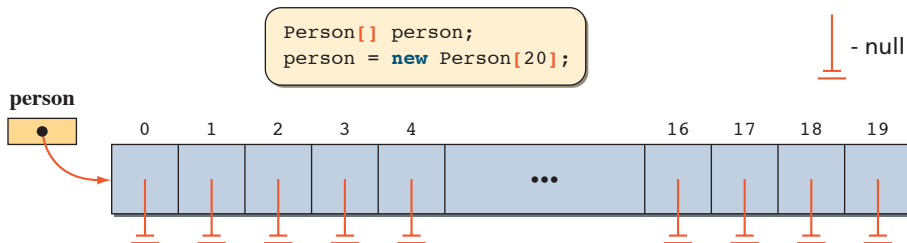

**Figure 10.4** An array of `Person` objects after the array is created.

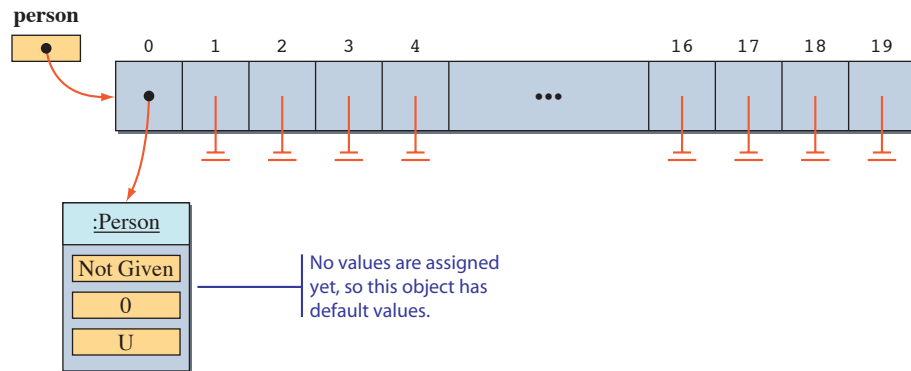

**Figure 10.5** The `person` array with one `Person` object added to it.

refers to the first object in the `person` array. Since this expression refers to an object, we write

```
person[0].setAge(20);
```

to call this `Person` object's `setAge` method, for example. This is the syntax we use to call an object's method. We are just using an indexed expression to refer to an object instead of a simple variable.

Let's go through typical array processing to illustrate the basic operations. The first is to create `Person` objects and set up the `person` array. We assume that the `person` array is already declared and created.

```
String name, inpStr;
int age;
char gender;

for (int i = 0; i < person.length; i++) {
 //read in data values
 System.out.print("Enter name: ");
 name = scanner.next();

 System.out.print("Enter age: ");
 age = scanner.nextInt();

 System.out.print("Enter gender: ");
 inpStr = scanner.next();
 gender = inpStr.charAt(0);

 //create a new Person and assign values
 person[i] = new Person();

 person[i].setName (name);
 person[i].setAge (age);
 person[i].setGender(gender);
}
```

*Note:* To focus on array processing, we used the most simplistic input routine. For instance, we did not perform any input error checking, but this is not to say that input error checking is unimportant. We simply want to focus on array processing here.

To find the average age, we execute

find the average age

```
double sum = 0, averageAge;

for (int i = 0; i < person.length; i++) {
 sum += person[i].getAge();
}

averageAge = sum / person.length;
```

To print out the name and age of the youngest and the oldest persons, we can execute

find the youngest and the oldest persons

```
String nameOfYoungest, nameOfOldest;
int min, max, age;

nameOfYoungest = nameOfOldest = person[0].getName();
min = max = person[0].getAge();

for (int i = 1; i < person.length; i++) {
 age = person[i].getAge();

 if (age < min) { //found a younger person
 min = age;
 nameOfYoungest = person[i].getName();
 } else if (age > max) { //found an older person
 max = age;
 nameOfOldest = person[i].getName();
 }
}

System.out.println("Oldest : " + nameOfOldest + " is "
 + max + " years old.");

System.out.println("Youngest: " + nameOfYoungest + " is "
 + min + " years old.");
```

Instead of using separate String and int variables, we can use the index to the youngest and the oldest persons. Here's the code:

```
int minIdx, //index to the youngest person
 maxIdx; //index to the oldest person

minIdx = maxIdx = 0;

for (int i = 1; i < person.length; i++) {

 if (person[i].getAge() < person[minIdx].getAge()) {
 //found a younger person
 minIdx = i;
 }
}
```

```

 }else if (person[i].getAge() > person[maxIdx.getAge()]){
 //found an older person
 maxIdx = i;
 }
}

System.out.println("Oldest : " + person[maxIdx].getName()
 + " is "
 + person[maxIdx].getAge()
 + " years old.");

System.out.println("Youngest: " + person[minIdx].getName()
 + " is "
 + person[minIdx].getAge()
 + " years old.");

```

Yet another approach is to use variables for `Person` objects. Figure 10.6 shows how the `Person` variables `oldest` and `youngest` point to objects in the `person` array. Here's the code using `Person` variables:

```

Person youngest, //points to the youngest person
 oldest; //points to the oldest person

youngest = oldest = person[0];

for (int i = 1; i < person.length; i++) {

 if (person[i].getAge() < youngest.getAge()) {
 //found a younger person
 youngest = person[i];
 }
}

```

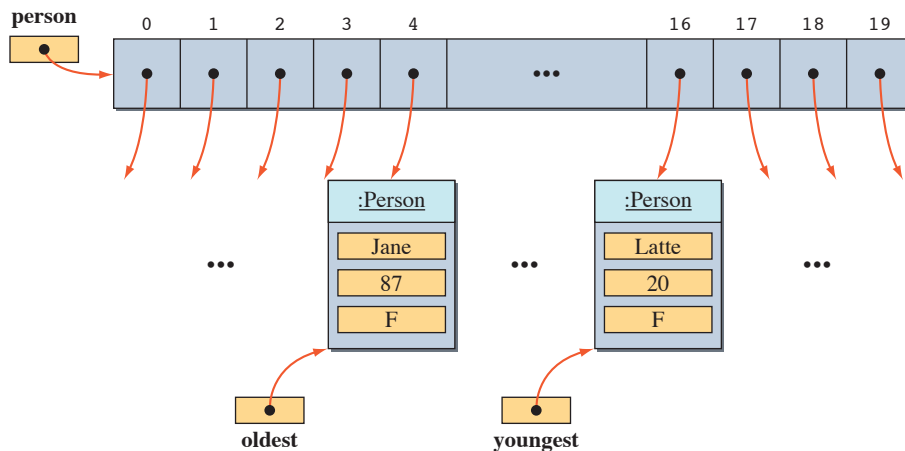

**Figure 10.6** An array of `Person` objects with two `Person` variables.



```

 else if (person[i].getAge() > oldest.getAge()) {
 //found an older person
 oldest = person[i];
 }
 }

 System.out.println("Oldest : " + oldest.getName()
 + " is " + oldest.getAge() + " years old.");

 System.out.println("Youngest: " + youngest.getName()
 + " is " + youngest.getAge() + " years old.");

```

find a particular person

Our next example is to search for a particular person. We can scan through the array until the desired person is found. Suppose we want to search for a person whose name is Latte. If we assume the person is in the array, then we can write

```

int i = 0;
while (!person[i].getName().equals("Latte")) {
 i++;
}

System.out.println("Found Ms. Latte at position " + i);

```

The expression

```
person[i].getName().equals("Latte")
```

is evaluated left to right and is equivalent to

```

Person p = person[i];
String str= p.getName();

str.equals("Latte");

```

In this example, we assume that the person for whom we are searching is in the array. If we cannot assume this, then we need to rewrite the terminating condition to take care of the case when the person is not in the array. Here's how:

```

int i = 0;

while (i < person.length && //still more persons to search
 !person[i].getName().equals("Latte")) {
 i++;
}

if (i == person.length) {
 //not found - unsuccessful search
 System.out.println("Ms. Latte was not in the array");
} else {
 //found - successful search
 System.out.println("Found Ms. Latte at position " + i);
}

```

Here's the complete program that summarizes the topics covered so far in this section:

```

/*
Chapter 10 Sample Program: Illustrate the processing
 of an array of Person objects

File: Ch10ProcessPersonArray.java
*/
import java.util.*;

class Ch10ProcessPersonArray {
 public static void main (String[] args) {
 Person[] person; //declare the person array
 person = new Person[5]; //and then create it

 //----- Create person Array -----//

 String name, inpStr;
 int age;
 char gender;

 for (int i = 0; i < person.length; i++) {
 //read in data values
 System.out.print("Enter name: ");
 name = scanner.next();

 System.out.print("Enter age: ");
 age = scanner.nextInt();

 System.out.print("Enter gender: ");
 inpStr = scanner.next();
 gender = inpStr.charAt(0);

 //create a new Person and assign values
 person[i] = new Person();

 person[i].setName (name);
 person[i].setAge (age);
 person[i].setGender(gender);
 }

 //----- Compute Average Age -----//

 float sum = 0, averageAge;

 for (int i = 0; i < person.length; i++) {
 sum += person[i].getAge();
 }
 }
}

```

```

averageAge = sum / (float) person.length;

System.out.println("Average age: " + averageAge);
System.out.println("\n");

//----- Find the youngest and oldest persons -----//
//----- Approach No. 3: Using person reference -----//

Person youngest, //points to the youngest person
 oldest; //points to the oldest person

youngest = oldest = person[0];

for (int i = 1; i < person.length; i++) {
 if (person[i].getAge() < youngest.getAge()) {
 //found a younger person
 youngest = person[i];
 }
 else if (person[i].getAge() > oldest.getAge()) {
 //found an older person
 oldest = person[i];
 }
}

System.out.println("Oldest : " + oldest.getName()
 + " is " + oldest.getAge() + " years old.");

System.out.println("Youngest: " + youngest.getName()
 + " is " + youngest.getAge() + " years old.");

//----- Search for a particular person -----//

System.out.print("Name to search: ");
String searchName = scanner.next();

int i = 0;

while (i < person.length && //still more persons to search
 !person[i].getName().equals(searchName)) {
 i++;
}

if (i == person.length) {
 //not found - unsuccessful search
 System.out.println(searchName + " was not in the array");
} else {
 //found - successful search
 System.out.println("Found " + searchName + " at position " + i);
}
}
}

```

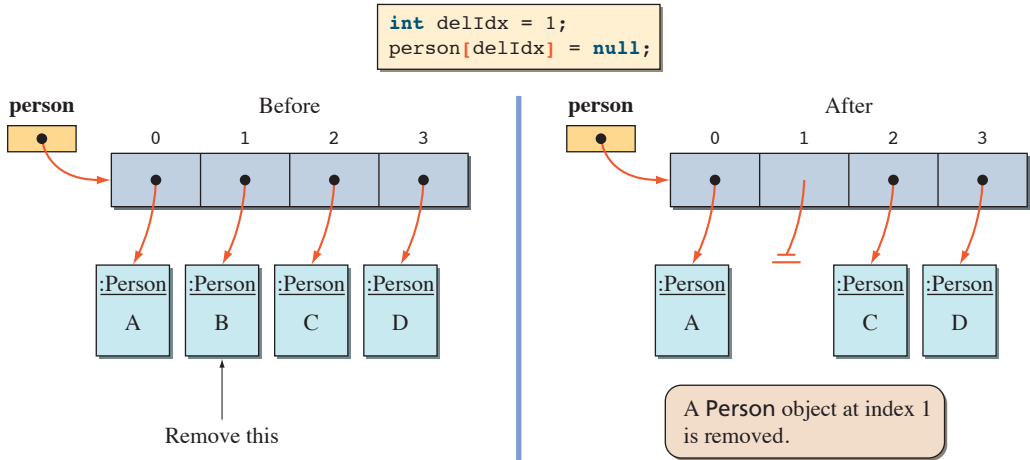
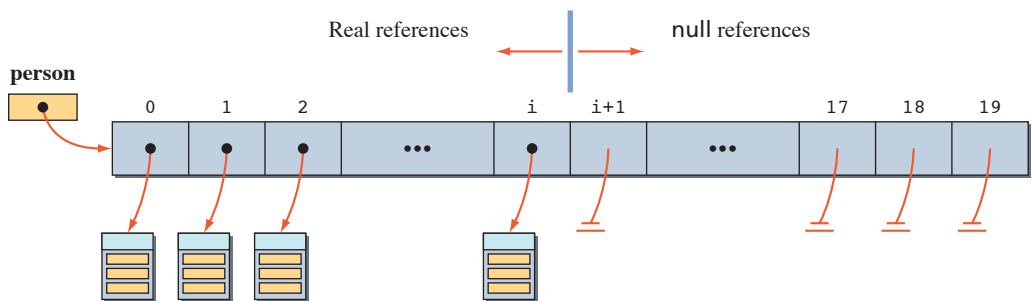

**Figure 10.7** Approach 1 deletion: setting a reference to **null**. The array length is 4.

delete a particular person

Now let’s consider the deletion operation. The deletion operation requires some kind of a search routine to locate the **Person** object to be removed. To concentrate on the deletion operation, we will assume there’s a search method that returns the index of the **Person** object in the array to be removed. There are two possible ways to remove an object from the array. The first approach is to reset the array element to null. Remember that each element in an array of objects is a reference to an object, so removing an object from an array could be accomplished by setting the reference to null. Figure 10.7 illustrates how the object at position 1 is deleted by using approach 1.

With approach 1, any index position can be set to null, so there can be “holes,” that is, null references, anywhere in the array. Instead of intermixing real and null references, the second approach will pack the elements so that the real references occur at the beginning and the null references at the end:



With approach 2, we must fill the hole. There are two possible solutions. The first solution is to pack the elements. If an object at position **J** is removed

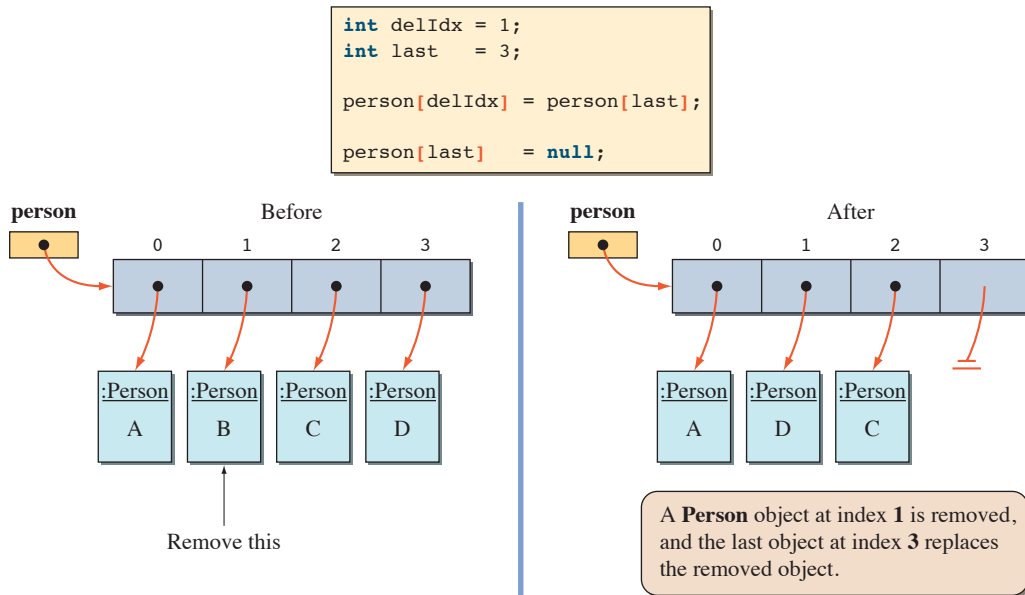

**Figure 10.8** Approach 2 deletion: replace the removed element with the last element in the array. The array length is 4.

(i.e., this position is set to null), then elements from position  $J+1$  up to the last non-null reference are shifted one position lower. And, finally, the last non-null reference is set to null. The second solution is to replace the removed element by the last element in the array. The first solution is necessary if the `Person` objects are arranged in some order (e.g., in ascending order of age). The second solution is a better one if the `Person` objects are not arranged in any order. Since we are not arranging them in any order, we will use the second solution. Figure 10.8 illustrates how the object at position 1 is replaced by the last element.

The search routine we presented earlier in this section assumes the full array; that is, all elements are non-null references. With the deletion routine, either approach 1 or 2, given above, an array element could be a null. The search routine must therefore be modified to skip the null references (for approach 1) or to stop the search when the first null reference is encountered (for approach 2).

In both Figures 10.7 and 10.8, we removed the icon for `Person B` in the diagrams when the array element was set to null as though the object were erased from the memory. Eventually, the object will indeed be erased, but the operation of assigning null to the array element will not erase the object by itself. The operation simply initiates a chain reaction that will eventually erase the object from the memory.

As we have shown several times already, a single object can have multiple references pointing to it. For example, the following code will result in two references

pointing to a single Person object:

```
Person p1, p2;
p1 = new Person();
p2 = p1;
```

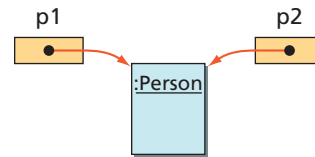

garbage  
collection

When an object has no references pointing to it, then the system will erase the object and make the memory space available for other uses. We call the erasing of an object *deallocation* of memory, and the process of deallocating memory is called *garbage collection*. Garbage collection is done automatically in Java, but in other programming languages, such as C++, you must include a statement in the program to deallocate memory.



1. Which of these statements are invalid?

- a. `Person[25] person;`
- b. `Person[ ] person;`
- c. `Person person[] = new Person[25];`
- d. `Person person[25] = new Person[25];`

2. Write a code fragment to print out the names of those who are older than 20. Assume the following declaration and that the array is already set up correctly.

```
Person[] friend = new Person[100];
```

## 10.3 The For-Each Loop

In Chapter 6, we mentioned a new form of the for loop that is introduced in Java 5.0. There is no official name to this for loop, but the term *for-each* is used most often. The term *enhanced for loop* is also used by many to refer to this for loop. We will use both terms interchangeably in this book.

We will show here how to use the for-each loop in processing an array. We will show how to use it in processing a collection in Section 10.5. Let's assume `number` is an `int` array of 100 integers. Using the standard for loop, we compute the sum of all elements in the `number` array as follows:

```
int sum = 0;
for (int i = 0; i < number.length; i++) {
 sum = sum + number[i];
}
```

By using a for-each loop, we can compute the sum as follows:

```
int sum = 0;
for (int value : number) {
 sum = sum + value;
}
```

The loop iterates over every element in the `number` array, and the loop body is executed for each iteration. The variable `value` refers to each element in the array during the iteration. So we can interpret this loop as saying something like “For each value in `number`, execute the following loop body.”

The general syntax for the for-each loop is

```
for (<type> <variable> : <array>)
 <loop body>
```

where `<type>` is the data type of `<variable>`, `<array>` the name of the array, and `<loop body>` is a sequence of 0 or more statements (the left and right braces are required if there is more than one statement in the loop body).

### Hints, & Tips, Pitfalls



We cannot use the for-each loop directly to a string to access individual characters in it. However, the **String** class includes a method named **toCharArray** that returns a string data as an array of **char** data, and we can use the for-each loop on this array of char data. Here’s an example:

```
String sample = "This is a test";
char[] charArray = sample.toCharArray();
for (char ch: charArray) {
 System.out.print(ch + " ");
}
```

If we do not need to access the **char** array later, then we can write the code in a slightly less verbose way as follows:

```
String sample = "This is a test";
for (char ch: sample.toCharArray()) {
 System.out.print(ch + " ");
}
```

Let’s look at another example. This time we use an array of objects. Suppose we have an array of 100 `Person` objects called `person`:

```
Person[] person = new Person[100];
```

The `Person` class is defined in Section 10.2. Assuming that 100 `Person` objects are created and assigned to `person[0]` to `person[99]`, we can list the name of every person in the array by using the following for-each loop:

```
for (Person p : person) {
 System.out.println(p.getName());
}
```

Contrast this to the standard for loop:

```
for (int i = 0; i < person.length; i++) {
 System.out.println(person[i].getName());
}
```

The for-each loop is, in general, cleaner and easier to read.

There are several restrictions on using the for-each loop. First, you cannot change an element in the array during the iteration. The following code does not reset the array elements to 0:

```
int [] number = {10, 20, 30, 40, 50};
for (int value : number){
 value = 0;
}
for (int value : number) {
 System.out.println(value);
}
```

This loop has no effect.

The first for-each loop has no effect, so the output from this code will be

```
10
20
30
40
50
```

We can characterize the for-each loop as a read-only iteration of the elements.

### Hints, & Tips, Pitfalls



The for-each loop only allows access to the elements. The elements cannot be changed.



For an array of objects, an element is actually a reference to an object, so the following for-each loop is ineffective. Specifically, it does not reset the elements to null.

```
Person[] person = new Person[100];

for (int i = 0; i < person.length; i++) {
 person[i] = ...; //code to create a new Person object
}

for (Person p : person) {
 p = null;
}
```

This loop has no effect.

Although we cannot change the elements of an array, we can change the content of an object if the element is a reference to an object. For example, the following for-each loop will reset the names of all objects to Java:

```
Person[] person = new Person[100];

for (int i = 0; i < person.length; i++) {
 person[i] = ...; //code to create a new Person object
}

for (Person p : person) {
 p.setName("Java");
}
```

This loop is effective. The name of every Person object is set to Java.

Notice that we are not changing the elements (references to objects) themselves, but the content of the objects referenced by these elements. Thus, the code is effective.

The second restriction is that we cannot access more than one array using a single for-each loop. Suppose we have two integer arrays num1 and num2 of length 200 and want to create a third array num3 whose elements are sum of the corresponding elements in num1 and num2. Here's the standard for loop:

```
int[] num1 = new int[200];
int[] num2 = new int[200];
int[] num3 = new int[200];

//code to assign values to the elements of num1 and num2

//compute the sums
for (int i = 0; i < num3.length; i++) {
 num3[i] = num1[i] + num2[i];
}
```

Such a loop cannot be written with a for-each loop.



The for-each loop allows access to only a single array.

The third restriction is that we must access all elements in an array from the first to the last element. We cannot, for example, access only the first half or the last half of the array. We cannot access elements in reverse order either.



The for-each loop iterates over every element of an array from the first to the last element. We cannot use the for-each loop to access only a portion of an array or to access the elements in reverse order.

This restriction complicates the matter when we try to access elements in an array of objects. Consider the following code:

```
Person[] person = new Person[100];

for (int i = 0; i < 50; i++) {
 person[i] = ...; //code to create a new Person object
}

for (Person p : person) {
 System.out.println(
 p.getName());
}
```

This loop will result in a  
**NullPointerException** error.

This code will crash when the variable `p` is set to the 51st element (i.e., an element at index position 50), because the element is null. Notice that only the first 50 elements actually point to `Person` objects. The elements in the second half of the array are all null.



1. Rewrite the following for loop by using a for-each loop.

```
for (int i = 0; i < number.length; i++) {
 System.out.println(number[i]);
}
```

2. Rewrite the following for loop by using the standard for loop.

```
for (Person p : person) {
 System.out.println(p.getName());
}
```

3. Why can't the following for loop be expressed as a for-each loop?

```
for (int i = 0; i < number.length; i++) {
 number[i] = number[i] + 50;
}
```

## 10.4 | Passing Arrays to Methods

We discussed the passing of an object to a method by using String objects as illustrations in Chapter 4. Since both an array and an object are a reference data type, the rules for passing an object to a method and returning an object from the method apply to arrays also. However, there are some additional rules we need to remember in passing an array to a method and returning it from a method. We will cover these topics in this section.

Let's define a method that returns the index of the smallest element in an array of real numbers. The array to search for the smallest element is passed to the method. Here's the method:

```
public int searchMinimum(double[] number) {
 int indexOfMinimum = 0;
 for (int i = 1; i < number.length; i++) {
 if (number[i] < number[indexOfMinimum]) { //found a
 indexOfMinimum = i; //smaller element
 }
 }
 return indexOfMinimum;
}
```

Notice that we use the square brackets to designate that `number` is an array. The square brackets may also be attached to the parameter, as in

```
public int searchMinimum(double number[])
```

To call this method (from a method of the same class), we write something like this:

```
double[] arrayOne, arrayTwo;

//create and assign values to arrayOne and arrayTwo
...
//get the index of the smallest element of arrayOne
int minOne = searchMinimum(arrayOne);

//get the index of the smallest element of arrayTwo
int minTwo = searchMinimum(arrayTwo);

//output the result
System.out.print("Minimum value in Array One is ");
System.out.print(arrayOne[minOne] + " at position "
 + minOne);

System.out.print("\n\n");

System.out.print("Minimum value in Array Two is ");
System.out.print(arrayTwo[minTwo] + " at position "
 + minTwo);
```

Just like other objects, an array is a reference data type, so we are passing the reference to an array, not the whole array, when we call the `searchMinimum` method. For example, when the method is called with `arrayOne` as its argument, the states of memory illustrated in Figures 10.9 and 10.10 will result. There are two references to the same array. The method does not create a separate copy of the array.

## Things to Remember



*When an array is passed to a method, only its reference is passed. A copy of the array is not created in the method.*

Now let's try another example in which we return an array (actually the reference to the array) from a method. Suppose we want to define a method that inputs double values and returns the values as an array of double. We can define the method as follows:

```
public double[] readDoubles() {
 double[] number;
 System.out.print("How many input values? ");
 int N = scanner.nextInt();
 number = new double[N];
}
```

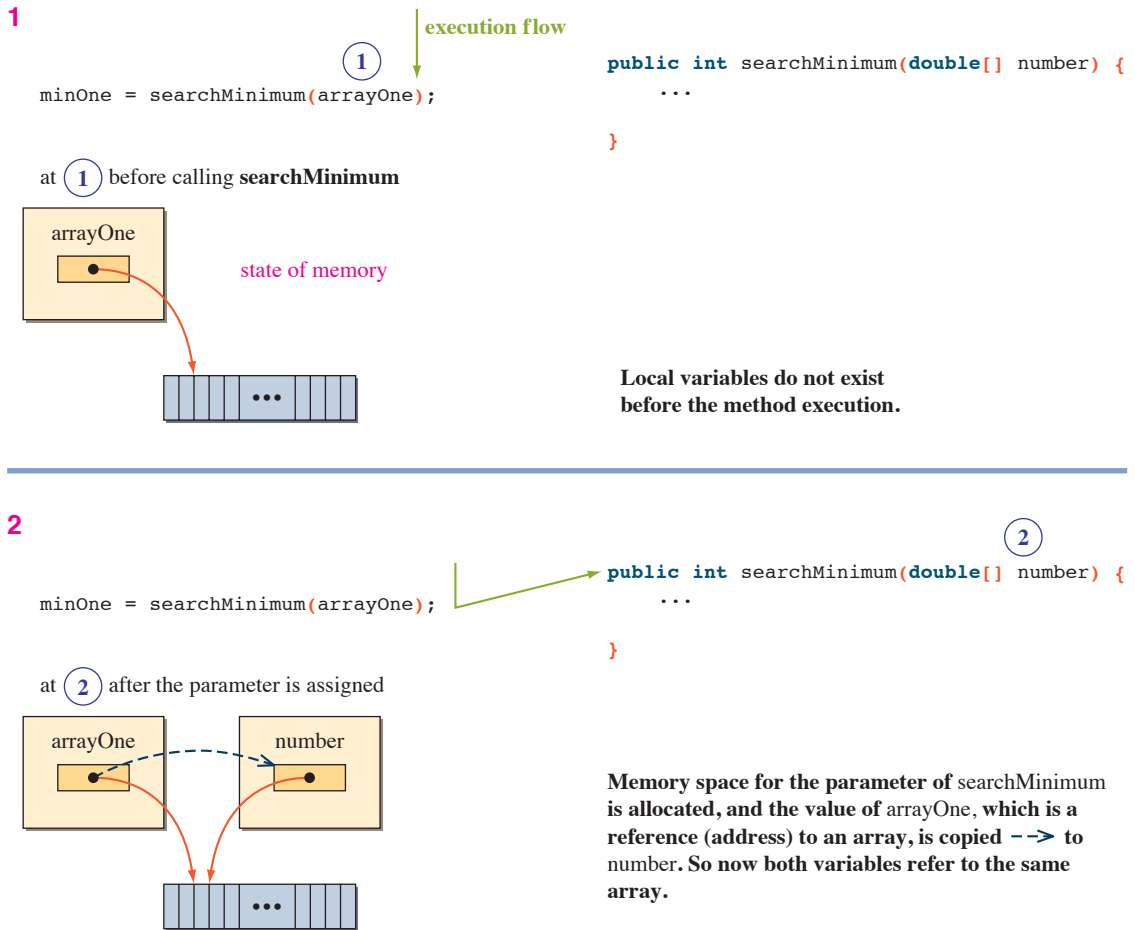

**Figure 10.9** Passing an array to a method means we are passing a reference to an array. We are not passing the whole array.

```

for (int i = 0; i < N; i++) {
 System.out.print("Number " + i + ": ");
 number[i] = scanner.nextDouble();
}
return number;
}

```

The square brackets beside the method return type `double` indicate that the method returns an array of `double`. Because an array is a reference data type, when we say “returns an array of `double`,” we are really saying “returns the reference to

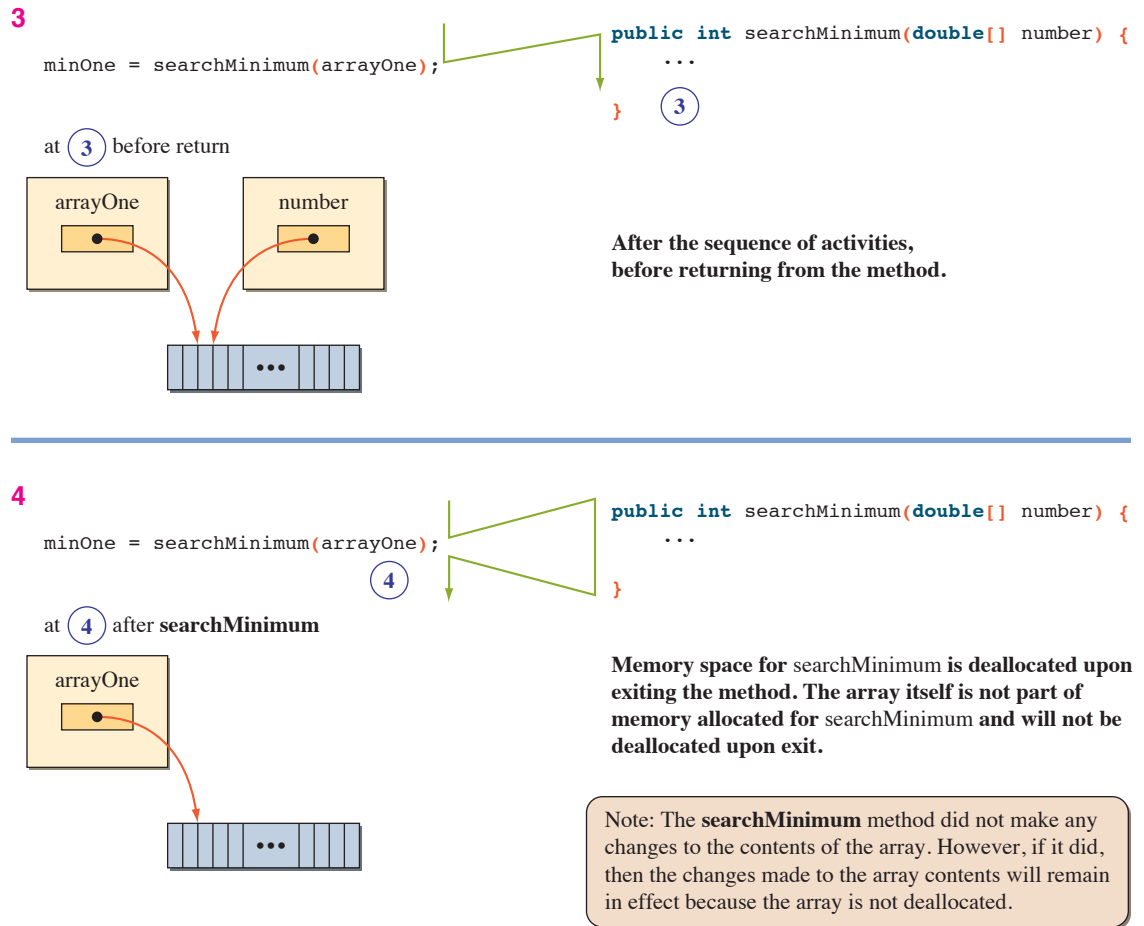

**Figure 10.10** Continuation of Figure 10.9.

an array of double.” We will use the shorter expression in general and use the longer expression only when we need to be precise.

The `readDoubles` method is called in this manner:

```
double[] arrayOne, arrayTwo;

//assign values to arrayOne and arrayTwo
arrayOne = readDoubles();

arrayTwo = readDoubles();
```

Since a new array is created by the method, we do not have to create an array from the calling side. In other words, we don't have to do this:

```
double[] arrayOne, arrayTwo;

arrayOne = new double[30]; //this is NOT necessary

arrayOne = readDoubles();
```

It won't cause an error if we create an array from the calling side, but we are doing a very wasteful operation. First, it takes up extra memory space. Second, it slows down the whole operation because the computer must garbage-collect the extra memory space that is not being used.

Let's try an alternative approach. This time, instead of creating an array inside the method and returning the array, the calling side creates an array and passes this array to the method:

```
int[] myIntArray = new int[50];

readIntegers(myIntArray);
```

The method `readIntegers` fills the passed array with integers. The method is defined as follows:

```
public void readIntegers(int[] number) {
 for (int i = 0; i < number.length; i++) {
 System.out.print("Number " + i + ": ");
 number[i] = scanner.nextDouble();
 }
}
```

Notice the return type of `readIntegers` is `void` because we are not returning an array. The method modifies the array that is passed to it.

Be careful not to mix the two alternative approaches. The following method will not work:

```
public void badMethod(double[] number) {
 System.out.print("How many input values? ");
 int N = scanner.nextInt();
 number = new double[N];

 for (int i = 0; i < N; i++) {
 System.out.print("Number " + i + ": ");
 number[i] = scanner.nextDouble();
 }
}
```

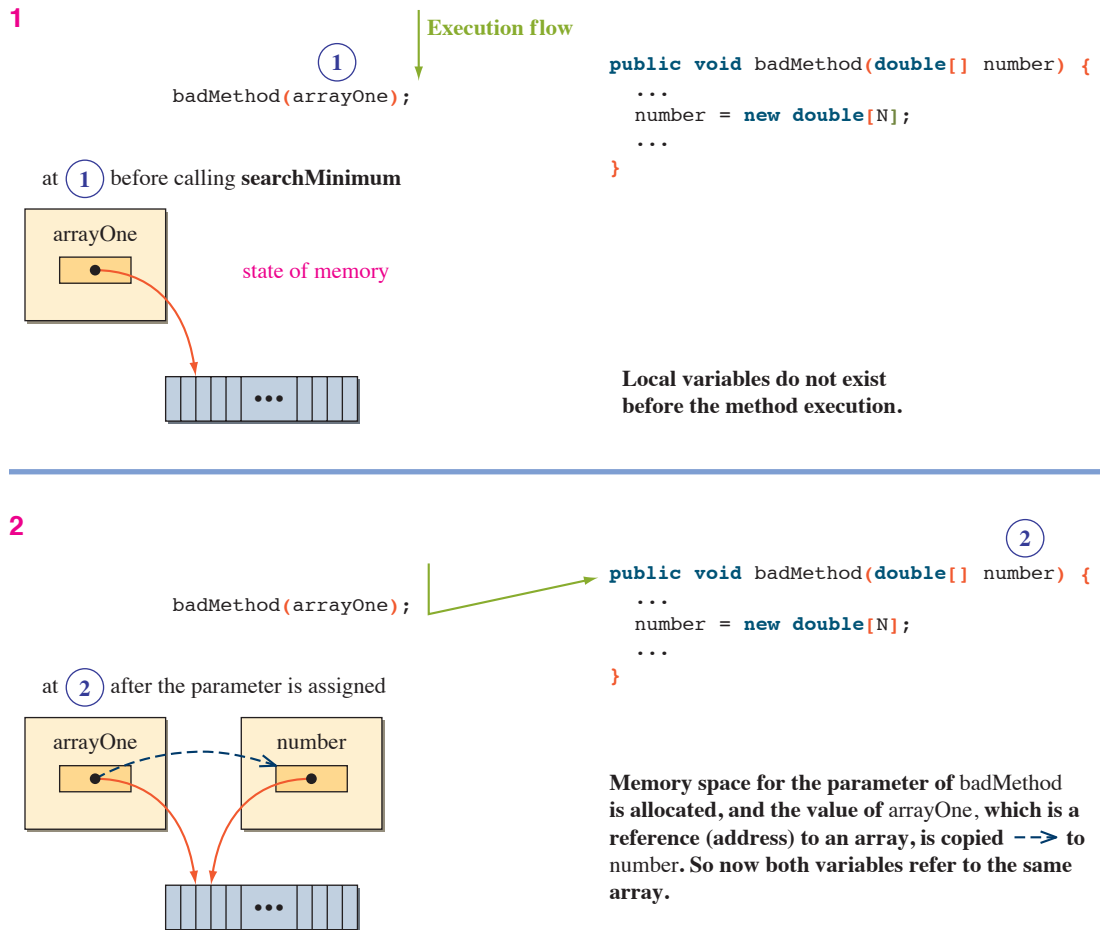

**Figure 10.11** Effect of creating a local array and not returning it.

Code such as

```
double[] arrayOne = new double[30];
badMethod(arrayOne);
```

will leave arrayOne unchanged. Figures 10.11 and 10.12 show the effect of creating a local array in badMethod and not returning it. (*Note:* The return type of badMethod is void.)



1. What will be an output from the following code?

```
int[] list = {10, 20, 30, 40 };
myMethod(list);
System.out.println(list[1]);
```



3

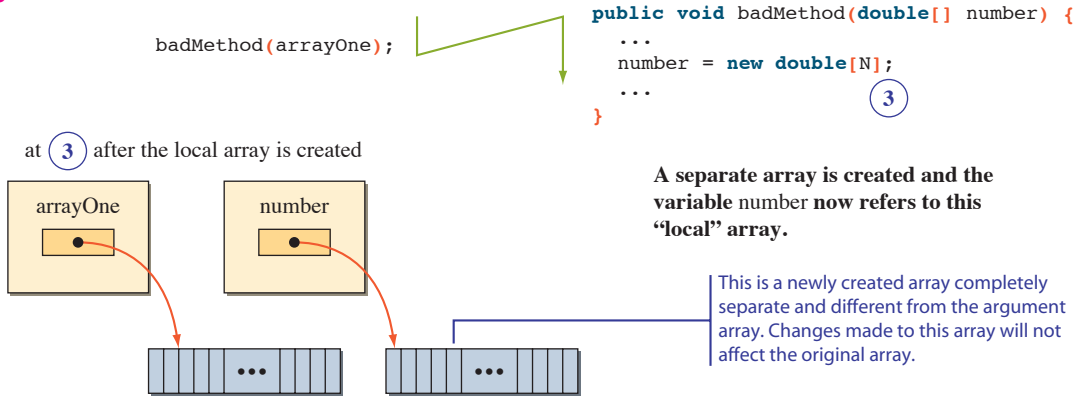

4

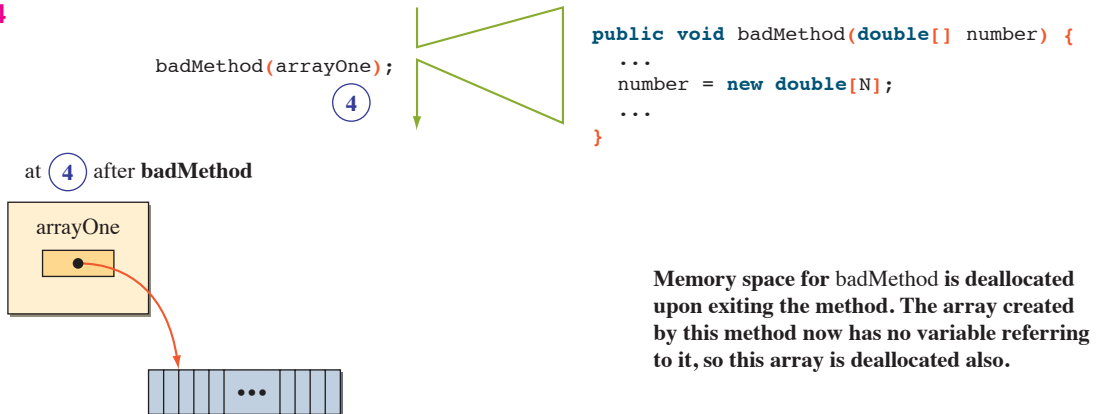

**Figure 10.12** Continuation of Figure 10.11.

```
System.out.println(list[3]);
...
public void myMethod(int[] intArray) {
 for (int i = 0; i < intArray.length; i+=2) {
 intArray[i] = i;
 }
}
```

2. If we replace `myMethod` of question 1 with the following, what will be an output?

```
public void myMethod(int[] intArray)
{
 int[] local = intArray;
 for (int i = 0; i < local.length; i+=2) {
 local[i] = i;
 }
}
```

## 10.5 Two-Dimensional Arrays

two-dimensional array

A table organized in rows and columns is a very effective means for communicating many different types of information. Figure 10.13 shows sample data displayed in a tabular format. In Java, we represent tables as *two-dimensional arrays*. The arrays we have discussed so far are *one-dimensional arrays* because they have only one index. In this section, we describe how two-dimensional arrays are used in Java.

Let's begin with an example. Consider the following table with four rows and five columns. The table contains the hourly rate of programmers based on their skill level. The rows (horizontal) represent the grade levels, and the columns (vertical)

**Distance Table (in miles)**

|               | Los Angeles | San Francisco | San Jose | San Diego | Monterey |
|---------------|-------------|---------------|----------|-----------|----------|
| Los Angeles   | —           | 600           | 500      | 150       | 450      |
| San Francisco | 600         | —             | 100      | 750       | 150      |
| San Jose      | 500         | 100           | —        | 650       | 50       |
| San Diego     | 150         | 750           | 650      | —         | 600      |
| Monterey      | 450         | 150           | 50       | 600       | —        |

**Multiplication Table**

|   | 1 | 2  | 3  | 4  | 5  | 6  | 7  | 8  | 9  |
|---|---|----|----|----|----|----|----|----|----|
| 1 | 1 | 2  | 3  | 4  | 5  | 6  | 7  | 8  | 9  |
| 2 | 2 | 4  | 6  | 8  | 10 | 12 | 14 | 16 | 18 |
| 3 | 3 | 6  | 9  | 12 | 15 | 18 | 21 | 24 | 27 |
| 4 | 4 | 8  | 12 | 16 | 20 | 24 | 28 | 32 | 36 |
| 5 | 5 | 10 | 15 | 20 | 25 | 30 | 35 | 40 | 45 |
| 6 | 6 | 12 | 18 | 24 | 30 | 36 | 42 | 48 | 54 |
| 7 | 7 | 14 | 21 | 28 | 35 | 42 | 49 | 56 | 63 |
| 8 | 8 | 16 | 24 | 32 | 40 | 48 | 56 | 64 | 72 |
| 9 | 9 | 18 | 27 | 36 | 45 | 54 | 63 | 72 | 81 |

**Tuition Table**

|             | Day Students | Boarding Students |
|-------------|--------------|-------------------|
| Grades 1–6  | \$16,000.00  | \$28,000.00       |
| Grades 7–8  | \$19,000.00  | \$31,000.00       |
| Grades 9–12 | \$22,500.00  | \$34,500.00       |

**Figure 10.13** Examples of information represented as tables.

represent the steps within a grade level. Reading the table, we know a programmer with skill grade level 2, step 1 earns \$36.50 per hour.

| Grade | Step  |       |       |       |       |
|-------|-------|-------|-------|-------|-------|
|       | 0     | 1     | 2     | 3     | 4     |
| 0     | 10.50 | 12.00 | 14.50 | 16.75 | 18.00 |
| 1     | 20.50 | 22.25 | 24.00 | 26.25 | 28.00 |
| 2     | 34.00 | 36.50 | 38.00 | 40.35 | 43.00 |
| 3     | 50.00 | 60.00 | 70.00 | 80.00 | 99.99 |

We declare the pay scale table as

```
double[][] payScaleTable;
```

or

```
double payScaleTable[][];
```

and create the array as

```
payScaleTable = new double[4][5];
```

The `payScaleTable` array is a *two-dimensional array* because two indices—one for the row and another for the column—are used to refer to an array element. For example, to refer to the element at the second column (column 1) of the third row (row 2), we say

```
payScaleTable[2][1]
```

Figure 10.14 illustrates how the two indices are used to access an array element of a two-dimensional array.

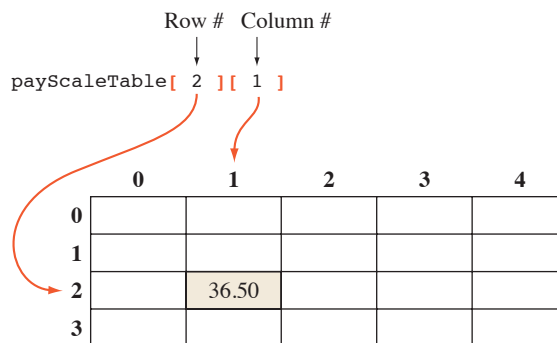

**Figure 10.14** Accessing an element of a two-dimensional array.

Let's go over some examples to see how the elements of two-dimensional arrays are manipulated. This code finds the average pay of the grade 2 programmers.

```
double average, sum = 0.0;

for (int j = 0; j < 5; j++) {
 sum += payScaleTable[2][j];
}

average = sum / 5;
```

The next example prints out the pay difference between the lowest and highest steps for each grade level.

```
double difference;

for (int i = 0; i < 4; i++) {
 difference = payScaleTable[i][4] - payScaleTable[i][0];
 System.out.println("Pay difference at Grade Level " +
 i + " is " + difference);
}
```

This code adds \$1.50 to every skill level.

```
for (int i = 0; i < 4; i++) {
 for (int j = 0; j < 5; j++) {
 payScaleTable[i][j] += 1.50;
 }
}
```

In the previous examples, we used literal constants such as 5 and 4 to keep them simple. For real programs, we need to write a loop that will work for two-dimensional arrays of any size, not just with the one with four rows and five columns. We can use the length field of an array to write such a loop. Using the length field, we can rewrite the third example as

```
for (int i = 0; i < payScaleTable.length; i++) {
 for (int j = 0; j < payScaleTable[i].length; j++) {
 payScaleTable[i][j] += 1.50;
 }
}
```

Do you notice a subtle difference in the code? Let's examine the difference between the expressions

```
payScaleTable.length
```

and

```
payScaleTable[i].length
```

First, there is actually no explicit structure called *two-dimensional array* in Java. We only have one-dimensional arrays in Java. However, we can have an array of arrays, and this is how the conceptual two-dimensional array is implemented in Java. The sample array creation

```
payScaleTable = new double[4][5];
```

is really a shorthand for

```
payScaleTable = new double[4][];
payScaleTable[0] = new double[5];
payScaleTable[1] = new double[5];
payScaleTable[2] = new double[5];
payScaleTable[3] = new double[5];
```

which is equivalent to

```
payScaleTable = new double[4][];
for (int i = 0; i < 4; i++) {
 payScaleTable[i] = new double[5];
}
```

Figure 10.15 shows the effect of executing the five statements. The expression

```
payScaleTable.length
```

refers to the length of the `payScaleTable` array itself.

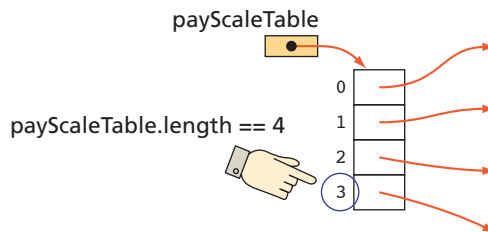

And the expression

```
payScaleTable[1].length
```

refers to the length of an array stored at row 1 of `payScaleTable`.

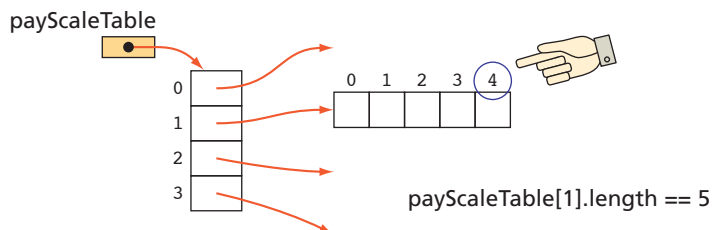

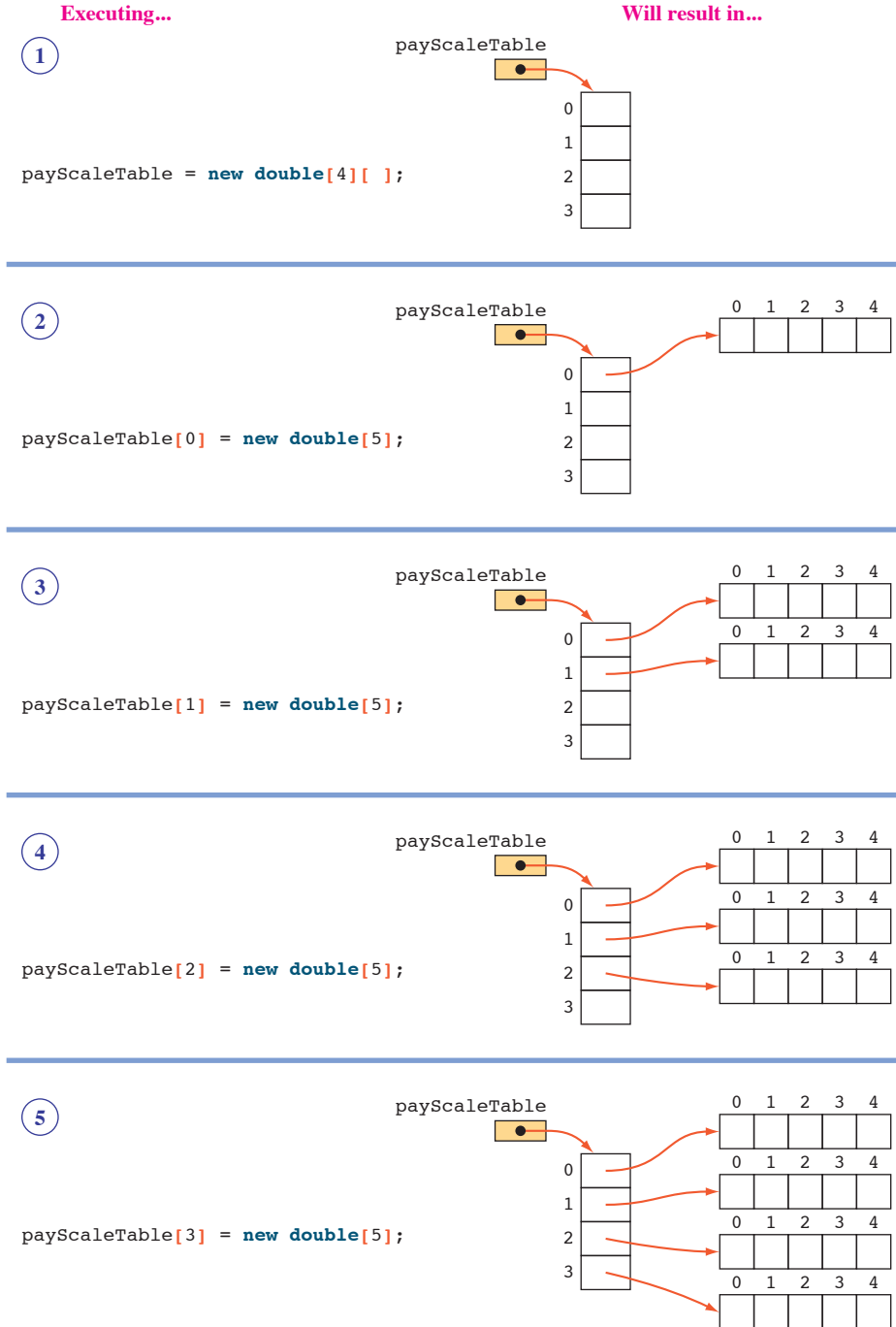
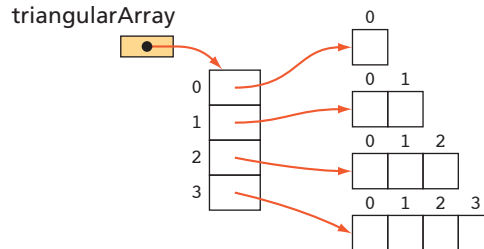

**Figure 10.15** Executing the statements on the left in sequence will create the array of arrays shown on the right.

We call an array that is part of another a *subarray*. The `payScaleTable` has four subarrays of the same length. Since we allocate the subarrays individually, we can create subarrays of different lengths. The following code creates a triangular array whose subarray `triangularArray[i]` has length `i`.

```
triangularArray = new double[4][];
for (int i = 0; i < 4; i++)
 triangularArray[i] = new double[i+1];
```

The resulting `triangularArray` looks like this:



An array of arrays can be initialized at the time of declaration. The following declaration initializes the `payScaleTable` array:

```
double[][] payScaleTable
= { {10.50, 12.00, 14.50, 16.75, 18.00},
 {20.50, 22.25, 24.00, 26.25, 28.00},
 {34.00, 36.50, 38.00, 40.35, 43.00},
 {50.00, 60.00, 70.00, 80.00, 99.99} };
```

Here's the complete sample program:

```
/*
Chapter 10 Sample Program: Sample program for processing
2-D array of double.

File: Ch10PayScaleTable.java
*/
class Ch10PayScaleTable {
 public static void main (String[] args) {
 double[][] payScaleTable
 = { {10.50, 12.00, 14.50, 16.75, 18.00},
 {20.50, 22.25, 24.00, 26.25, 28.00},
 {34.00, 36.50, 38.00, 40.35, 43.00},
 {50.00, 60.00, 70.00, 80.00, 99.99} };
```

```

//Find the average pay of level 2 employees
double sum = 0.0, average;

for (int j = 0; j < 5; j++) {
 sum += payScaleTable[2][j];
}

average = sum / 5;

System.out.println(" Average of Level 2 Employees: " + average);
System.out.println("\n");

//Display the pay difference at each grade level
double difference;

for (int i = 0; i < 4; i++) {
 difference = payScaleTable[i][4] - payScaleTable[i][0];
 System.out.println("Pay difference at Grade Level " +
 i + " is " + difference);
}

//Print out the pay scale table
System.out.println("\n");

for (int i = 0; i < payScaleTable.length; i++) {
 for (int j = 0; j < payScaleTable[i].length; j++) {
 System.out.print(payScaleTable[i][j] + " ");
 }
 System.out.println("");
}

//Increase the pay by 1.50 for every level/step
//and display the resulting table
System.out.println("\n");

for (int i = 0; i < payScaleTable.length; i++) {
 for (int j = 0; j < payScaleTable[i].length; j++) {
 payScaleTable[i][j] += 1.50;
 System.out.print(payScaleTable[i][j] + " ");
 }
 System.out.println("");
}
}
}
}

```



We can nest for-each loops to process a two-dimensional array. Remember that the two-dimensional array is structurally an array of arrays (as illustrated in Figure 10.15), and the nested for-each loops will make this fact explicit. To print out the pay scale table, for example, we write

```
for (double[] row : payScaleTable) {
 for (double pay : row) {
 System.out.print(pay + " ");
 }
 System.out.println("");
}
```

The outer loop iterates over the rows in the `payScaleTable` two-dimensional array. Each row is one-dimensional array of double, so the type is declared as `double[]`. And the inner loop iterates over the elements in each row. Notice that we cannot rewrite the other loop statements in the `Ch10PayScaleTable` program by using the for-each loop.

There is no limit to the number of dimensions an array can have. We can declare three-dimensional, four-dimensional, and higher-dimensional arrays. However, arrays with a dimension higher than 2 are not frequently used in object-oriented languages. For example, data that were represented as a three-dimensional array in a non-object-oriented language can be represented more naturally as a one-dimensional array of objects with each object containing an array or some other form of data structure (see Exercise 12 on page 615).



1. Write a code fragment to compute the average pay of the pays stored in the `payScaleTable` array.
2. Write a code fragment that finds the largest integer in this two-dimensional array.

```
int[][] table = new int[10][10];
```

3. What is an output from this code?

```
int[][] table = new int[10][5];
System.out.println(table.length);
System.out.println(table[4].length);
```

## 10.6 Lists and Maps

Once an array is created, its capacity cannot be changed. For example, if we create an array of 20 elements, then we are limited to store at most 20 elements in using this array. If we need to add elements, then we have to create a new array. (*Note:* We will learn how to do this in Section 10.7.) We call the condition in which an array does not have any unused position left to add another element an *array overflow*.

array overflow

Whenever we use arrays in an application, we need to consider the possibility of an array overflow. We can usually avoid an array overflow by declaring its capacity to be a large number. However, if we declare the capacity of an array too large, we may avoid an array overflow but end up underutilizing the space (e.g., using only 20 positions in an array with the capacity of 500). If we do not want our application to be limited to some fixed capacity, we need to write code that handles an array overflow by allocating a larger array.

If we need to handle an array overflow for multiple arrays we use in an application, we can define a class that handles the array overflow so we don't have to implement an overflow-handling code for individual arrays. We might call the new class `ExpandableArray`. By using this class, we can keep adding new elements without worrying about the overflow condition, because the class handles the overflow condition automatically.

It turns out there's no need for us to write such an `ExpandableArray` class because the Java standard library `java.util` already includes various classes and (interfaces) for maintaining a collection of objects. They are collectively referred as the *Java Collection Framework*, or *JCF*. We will study the basic ones in this section.

The first is the `List` interface. Like a class, an *interface* is a reference data type; but unlike a class, an interface includes only constants and abstract methods. An *abstract method* has only the method header (or, more formally, the *method prototype*); that is, it has no method body. The abstract methods of an interface define a behavior. For example, the `List` interface includes 25 abstract methods that collectively define a behavior of a linear list, such as adding an element, removing an element, and so forth.

We cannot create an instance of a Java interface. (*Note:* To differentiate a user interface from a reference data type interface, we will use the term *Java interface* to refer to the latter.) For example, the following will result in a compile-time error:

```
List myList = new List ();
```

To create an instance that will support a `List` behavior, we need a class that implements the `List` interface. We say a class implements an interface if it provides the method body to all the abstract methods defined in the Java interface.

There are two classes in JCF that implement the `List` interface: `ArrayList` and `LinkedList`. Because they implement the same interface, they behave exactly the same. That is, there's no difference in using them (as long as we use the methods defined in the `List` interface). They differ in the internal data structure they use to implement the interface. The `ArrayList` class uses an array, and the `LinkedList` class uses a technique called *linked-node representation*. We choose one over the other depending on the nature of application (e.g., choose `LinkedList` if the application requires frequent insertions and deletions of elements but occasional searching for elements in the list). It is beyond our scope to provide an in-depth comparative analysis here. In most situations, the `ArrayList` class would be preferable so we will use it for the examples in this chapter.

java.util

JCF

interface

abstract  
method

You  
Might  
Want to  
Know



There is another “expandable array” in the JCF called **Vector**. The **Vector** class pre-dates the JCF classes, but from Java 2 SDK 1.2, the class was modified to implement the **List** interface. Because it was designed before the JCF classes, it includes many methods in addition to the **List** methods. In general, the **ArrayList** class is recommended for most situations.

Let’s study how we can use the methods of the List interface. First we need to declare and create an instance of a class that implements the List interface. Let’s use the ArrayList class. From what we have learned so far about declaring and creating an instance of a class, we would write something like

```
ArrayList myList;
...
myList = new ArrayList();
```

Not recommended

if the class is ArrayList. This would work (you’ll get only a compiler warning), but it is not a recommended style of programming. There are two improvements we should make. The first is to declare the variable as the Java interface and to assign an instance of the class that implements the interface. Applying this improvement will result in

```
List myList;
...
myList = new ArrayList();
```

myList is declared as  
type List

Basically this style of declaration improves the ease of program modification. Suppose, for example, there are many methods that accept an ArrayList object

```
public void myMethod(ArrayList aList)
```

With this declaration, we can only pass an instance of ArrayList. Now suppose at a later time we decide to use LinkedList to improve performances for certain types of operations. We have to go back and make changes to all those method headers. But what if we declare the method from the beginning as follows?

```
public void myMethod(List aList)
```

Since we can pass an instance of either ArrayList or LinkedList (or an instance of any class that implements the List interface), no changes are required. We will study the Java interface in greater detail in Chapter 13.

The second improvement is specific to Java 5.0 and later JCF classes. If we declare a list object as

```
List myList = new ArrayList();
```

there are no restrictions on the type of objects we can add to the list. For example, we can add String objects, Person objects, Vehicle objects, and so forth to this myList.

heterogeneous  
listhomogeneous  
list

We call such list a *heterogeneous list*. In most applications, there is no need to maintain such heterogeneous lists. What we need is a *homogeneous list*, where the elements are restricted to a specific type such as a list of `Person` objects, a list of `String` objects, a list of `Book` objects, and so forth. Specifying the element type improves the program reliability because an error such as trying to add a wrong type of object to a list can be caught during the compile time. It is strongly recommended to use homogeneous lists.

To specify a homogeneous list, we must include the type of elements in the declaration and creation statements. Here's an example that declares and creates a list of `Person` objects:

```
List<Person> friends;
...
friends = new ArrayList<Person>();
```

The general syntax for the declaration is

```
interface-or-class-name < element-type > identifier;
```

And the general syntax for the creation is

```
identifier = new class-name < element-type > (parameters) ;
```

We can combine the two into a single statement as

```
interface-or-class-name < element-type > identifier
= new class-name < element-type > (parameters) ;
```

for example,

```
List<Person> friends = new ArrayList<Person>{ };
```

Now we are ready to study the basic operations of the `List` interface. Once a list is created properly, we can start adding elements. In the following example, we create a list named `friends` and **add** four `Person` objects to the list:

add

```
List<Person> friends = new ArrayList<Person>{ };
Person person;

person = new Person("Jane", 10, 'F');
friends.add(person);

person = new Person("Jack", 16, 'M');
friends.add(person);

person = new Person("Jill", 8, 'F');
friends.add(person);

person = new Person("John", 12, 'M');
friends.add(person);
```

## size

To find out the number of elements in a list, we use its `size` method. The following code will print out 3:

```
List<String> sample = new ArrayList<String>{ };
sample.add("One Java");
sample.add("One Java");
sample.add("One Java");

System.out.println(sample.size());
```

## get

We can access objects in a list by giving their index position in the list, much as we did with the array. We use the `get` method to access an object at index position *i*. For example, to access the `Person` object at position 3 (*note*: the first element is at position 0) in the `friends` list, we write

```
Person p = friends.get(3);
```

An invalid argument, such as a negative value or a value greater than `size() - 1`, will result in an `IndexOutOfBoundsException` error.

## traversal

One of the most common operations we perform on a list is *traversal*. This operation, also called *scanning* or *iteration*, accesses all elements in a list. To traverse a list from the first to the last element, we can use the for-each loop. Here's how we can print out the names of all those in the `friends` list by using the for-each loop:

```
for (Person p : friends) {
 System.out.println(p.getName());
}
```

## iterator

This for-each loop is actually a shortcut for using an iterator pattern. When we call the `iterator` method of a list, it returns an `Iterator` object (an instance of a class that implements the `Iterator` interface) that supports the two methods `hasNext` and `next`. Here's the code to print out the names of all those in the `friends` list by using an iterator:

```
Person p;

Iterator<Person> itr = friends.iterator();

while (itr.hasNext()) {
 p = itr.next();
 System.out.println(p.getName());
}
```

Again, the for-each loop is built on top of the iterator pattern as a syntactical shortcut, and wherever the iterator pattern is available, we can (and should) use the cleaner and less error-prone for-each loop.

The traversal operation is necessary to search a list for elements that meet some criterion. Let's say we want to print out the names of those in the friends list who are older than 10. Here's the code:

```
for (Person p : friends) {
 if (p.age() > 10) {
 System.out.println(p.getName());
 }
}
```

Instead of simply printing out their names, we could create another list to keep track of those who are older than 10:

```
List<Person> olderThan10List = new ArrayList<Person>();
for (Person p : friends) {
 if (p.age() > 10) {
 olderThan10List.add(p);
 }
}
```

The original friends list remains unchanged; that is, no objects are removed from the list. We simply have a second list that points to a subset of elements in the friends list. The situation can be illustrated as follows (two Person objects are older than 10):

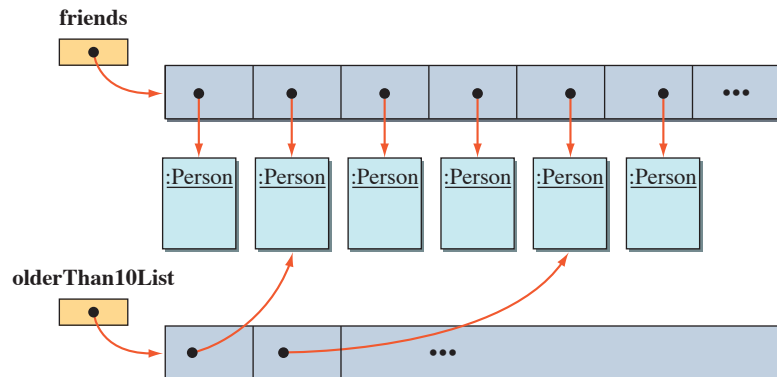

### remove

To remove an element from a list, we use the **remove** method. There are two versions: one specifies the index position of the object to remove, and the other specifies the object itself (i.e., the reference to this object). If we use the first version, here's how we remove the Person object at index position 2 in the friends list:

```
friends.remove(2);
```

The second version of the remove method requires a reference to an object. One way to acquire a reference to an object we want to remove is via traversal.

Here's the code that traverses the friends list and removes all Person objects who are older than 10:

```
List<Person> tempList = new ArrayList<Person>();

//first we collect those we want to remove from the
//friends list in a separate list
for (Person p : friends) {

 if (p.age() > 10) {
 tempList.add(p);
 }
}

//then we remove every element in tempList
//from the friends list
for (Person p : tempList) {

 friends.add(p);
}
```

Some of you might have thought about the following code:

```
for (Person p : friends) {

 if (p.age() > 10) {
 friends.remove(p);
 }
}
```

This is an invalid operation. We are not allowed to modify the list we are traversing. The for-each loop (and the underlying iterator pattern) is a read-only traversal.

### Hints, & Tips, & Pitfalls



No changes can be made to a list while traversing it with an iterator or a for-each loop.

### Lists and Primitive Data Types

With an array, we can store either primitive data values (int, double, etc.) or objects. With a list, we can store only objects. If we need to store primitive data values

in a list, then we must use wrapper classes such as `Integer`, `Float`, and `Double`. To specify a homogeneous list of integers, we have to do something like this:

```
List<Integer> intList = new ArrayList<Integer>();

intList.add(new Integer(15));
intList.add(new Integer(30));
...
```

When we access the elements of `intList`, which are `Integer` objects, we need to use the `intValue` method to get the integer value. The following code computes the sum of integer values stored in `intList`:

```
int sum = 0;

for (Integer intObj : intList) {
 sum = sum + intObj.intValue();
}
```

Instead of this tedious way of dealing with primitive data values, we can use automatic boxing and unboxing features (introduced in Java 5.0). We can write the code as if we could store primitive data values in lists. For example, the following code is valid:

```
List<Integer> intList = new ArrayList<Integer>();

intList.add(15);
intList.add(30);
...

int sum = 0;

for (int value : intList) {
 sum = sum + value;
}
```

Keep in mind that there are no structural changes. We are still adding `Integer` objects to `intList` (see the declaration for `intList`). It is just a syntactical shortcut. When we write, for example,

```
intList.add(30);
```

the compiler translates it to

```
intList.add(new Integer(30));
```

This is called *auto boxing*. And when we write

```
int num = intList.get(1);
```



the compiler translates it to

```
int num = intList.get(1).intValue();
```

This is called *auto unboxing*.

Let's conclude our discussion of the List interface with the BookTracker helper class we used in the Sample Development section of Chapter 7. The BookTracker class uses an ArrayList to keep track of library books. Here's the definition:

```

/*
Chapter 7 Sample Development: Library Overdue Checker
File: BookTracker.java
*/
import java.util.*;

class BookTracker {

 public static final int ERROR = -1;

 private List<LibraryBook> books;

 public BookTracker() {
 books = new LinkedList<LibraryBook>();
 }

 public void add(LibraryBook book) {
 books.add(book);
 }

 public double getCharge() {
 return getCharge(new GregorianCalendar()); //set today as due date
 }

 public double getCharge(GregorianCalendar returnDate) {

 if (books.isEmpty()) {
 return ERROR;
 } else {
 return totalCharge(returnDate);
 }
 }

 public String getList() {

 StringBuffer result = new StringBuffer("");
 String lineSeparator = System.getProperty("line.separator");

 for (LibraryBook book: books) {
 result.append(book.toString() + lineSeparator);
 }
 }
}

```

Constructor

add

getCharge

getList

```

 return result.toString();
}
private double totalCharge(GregorianCalendar returnDate) {
 double totalCharge = 0.0;
 for (LibraryBook book: books) {
 totalCharge += book.computeCharge(returnDate);
 }
 return totalCharge;
}
}

```



## Map

Let's move on to another useful interface called `Map`. There are two classes that implement this interface: `HashMap` and `TreeMap`. We will describe the `TreeMap` class in this section because this is the class we used in implementing the helper `WordList` class in Chapter 9. The `TreeMap` class actually implements a subinterface of `Map` called `SortedMap`, where the entries in the map are sorted.

A map consists of entries, with each entry divided into two parts: key and value. No duplicate keys are allowed in the map. Both key and value can be an instance of any class. The main advantage of a map is its performance in locating an entry, given the key. Consider, for example, that we want to maintain a table of course evaluations. For each course offered on campus, we want to keep an evaluation that is summarized from the student opinion poll collected at the end of the term. The course number (e.g., CS0101) is the key, and the evaluation is the value. We would want to store the information as a map because we need to look up the evaluation of a course efficiently, as there are hundreds or thousands of courses. The search would take too long if we used other data structures.

### Hints, & Tips, Pitfalls



As we know, a Java array allows only integer indices. In some situations we may want to use an array with indices other than integers. For example, a `WordList` from Chapter 9 can be viewed as an array of numbers with words (**String**) as its indices. A map can be characterized as an expandable array with nonintegers (i.e., instances of any class) as its indices. So whenever we need an array of values with noninteger indices, a map is a possible solution.

When declaring and creating a map, we must specify the type for the key and the value. For example, to declare and create a map with `String` as both its key and value, we write

```

Map<String,String> table;
table = new TreeMap<String,String>();

```

**put**

We use its **put** method to add the key-value pairs to the map as

```
table.put("CS0101", "Great course. Take it");
```

where the first argument is the key and the second argument is the value. To remove an entry, we use the **remove** method with the key of an entry to remove from the map, for example,

**remove**

```
table.remove("CS2300");
```

Instead of removing individual elements, we can remove all of them at once by calling the **clear** method. The statement

**clear**

```
table.clear();
```

removes everything from the map, making it an empty map.

**get**

To retrieve the value associated to a key, we call the map's **get** method.

```
String courseEval = table.get("CS102");
```

**contains key**

We can ask the map if it contains a given key. To check, for example, whether the map contains an evaluation for course number CS0455, we write

```
boolean result = table.containsKey("CS0455");
```

If there's no matching entry, then the value null is returned.

**entrySet**

To traverse a map, we must first call its **entrySet** method to get a set of elements. The method returns an instance of a class that implements the **Set** interface, another interface in JCF, that models a mathematical set. Those interested in using the **Set** interface are referred to the Java API documentation. The methods defined in the **Set** interface are very similar to those defined in the **List** interface. If we know how to use the **List** interface, then it won't take long for us to understand the **Set** interface.

An element in a map is a key-value pair, so the **entrySet** method returns a set of key-value pairs. A key-value pair is an instance of a class that implements the **Map.Entry** interface. The dot notation indicates that the **Entry** interface is defined in the declaration of the **Map** interface. Such a nested declaration is useful in avoiding a naming conflict.

Two useful methods defined in the **Map.Entry** interface are the **getKey** and **getValue**, whose purpose is to retrieve the key and the value of an entry, respectively. To put it all together, here's an example that outputs the course numbers and their evaluations stored in the table map:

```
for (Map.Entry<String,String> entry : table.entrySet()) {
 System.out.println(entry.getKey() + ":\n" +
 entry.getValue() + "\n");
}
```

Notice the type declaration for the loop variable `entry` is `Map.Entry<String, String>`. Because the key and value component of `Map.Entry` can be of any class, we need to indicate the actual type for the key and the value specific to this entry.

We are now ready to present the `WordList` class. It uses a `TreeMap` object to keep track of distinct words in a document and how many times they occur in the document. Notice the `TreeMap` class actually implements a more specialized map interface called `SortedMap`, a subinterface of the `Map` interface that adds the behavior of sorting the elements in ascending key order. This is exactly the data structure we want to use here because we want to access and display the words and their count in alphabetical order. Here's the definition:

```

/*
 Chapter 9 Sample Development: Word Concordance
 File: WordList.java
*/
import java.util.*;

class WordList {
 SortedMap<String, Integer> table;

 public WordList() {
 table = new TreeMap<String, Integer>();
 }

 public void add(String word) {
 int val;

 if (table.containsKey(word)) {
 val = table.get(word) + 1;
 } else {
 //word occurs for the first time
 val = 1;
 }

 table.put(word, val);
 }

 public String getConcordance(){
 String line;
 String lineTerminator
 = System.getProperties().getProperty("line.separator");
 StringBuffer strBuf = new StringBuffer("");

 for (Map.Entry<String,Integer> entry : table.entrySet()) {

```

Constructor

add

Auto boxing and unboxing are used in this method.

getConcordance

```

 line = entry.getValue().toString() + "\t" +
 entry.getKey() + lineTerminator;

 strBuf.append(line);
 }
 return strBuf.toString();
}
public void reset() {
 table.clear();
}
}

```



Compared to the amount of work the class has to perform, the length of its source code is rather short. This is so because the hard part of maintaining the data structure is done by the `TreeMap` class. Had we tried to implement the `WordList` class without using the `TreeMap` class, the source code would have been much longer. A little effort to study the JCF classes pays handsomely when the time comes for us to implement an efficient data manager class, such as the `WordList` class.



1. What is the output from the following code?

```

List<String> list = new ArrayList<String>();
for(int i = 0; i < 6; i++) {
 list.add("element " + i);
 System.out.println(list.size());
}

```

2. What is the output from the following code?

```

List<String> list = new ArrayList<String>();
for(int i = 0; i < 6; i++) {
 list.add("element " + i);
}

list.remove(1);
list.remove(3);

System.out.println(list.get(2));

```

3. Identify all errors in the following code.

```

List<String> list = new ArrayList<Integer>();
List<Person> people = new List<Person>();
Map<String> table = new Map();

```

## 10.7 Sample Development

## The Address Book

In this section, we will design a class called an **AddressBook** to maintain a collection of **Person** objects. The **AddressBook** class is implemented by using an array. We will use the **Person** class defined in Section 10.2. Through the design of the **AddressBook** class, we will reiterate the key principles of object-oriented design.

Notice that we are not developing a complete program here. We are designing only one of the many classes we need for a complete address book program. For the complete program, we need a main class, objects for doing input and output, and so forth. In this section, we will concentrate on one class that is only responsible for maintaining a collection of **Person** objects. This class will not perform, for example, input and output of **Person** objects, following the *single-task object* (STO) principle introduced in Chapter 4. We will discuss the importance of the STO principle while we develop the **AddressBook** class. One objective we have in designing the **AddressBook** class is to make the class reusable in many different programs. Many of the design decisions we will make during the development are based on implementing a reusable class.

### Problem Statement

*Write an **AddressBook** class that manages a collection of **Person** objects. An **AddressBook** object will allow the programmer to add, delete, or search for a **Person** object in the address book.*

### Overall Plan

Our first task is to come up with an overall design of the class. Let's begin by first identifying the core operations that an address book object must support. The problem statement indicated three major operations: add, delete, and search. These three operations are pretty much a standard in any collection of data values. For any kind of collections, you will always want to be able to add a new item, delete an old item, and search for an item or items. An address book is no exception as it is a collection of information about people for whom you would want to add, delete, and search data.

Our task here is to design a class that will maintain an address book by supporting these three operations. We will define three methods for the class: **add**, **delete**, and **search**.

Our working design document for the **AddressBook** class is therefore as follows:

| Design Document: The Public Methods of the AddressBook Class |                                                                                                     |
|--------------------------------------------------------------|-----------------------------------------------------------------------------------------------------|
| Method                                                       | Purpose                                                                                             |
| AddressBook                                                  | A constructor to initialize the object. We will include multiple constructors as necessary.         |
| add                                                          | Adds a new <b>Person</b> object to the address book.                                                |
| delete                                                       | Deletes a specified <b>Person</b> object from the address book.                                     |
| search                                                       | Searches for a specified <b>Person</b> object in the address book and returns this person if found. |

## 10.7 Sample Development—*continued*

develop-  
ment steps

We will implement the class in this order:

1. Implement the constructor(s).
2. Implement the **add** method.
3. Implement the **search** method.
4. Implement the **delete** method.
5. Finalize the class.

This order of development follows a natural sequence. To implement any instance method of a class, we need to be able to create a properly initialized object, so we will begin the class implementation by defining a constructor. As a part of defining a constructor, we will identify necessary data members. We will add more data members as we progress through the development steps. The second step is to implement the add routine, because without being able to add a new **Person** object, we won't be able to test other operations. For the third step, we will implement the search routine. And for the fourth step, we will implement the last routine. Although we could implement the delete routine before the search routine, we need some form of searching to test the correctness of the delete routine. In other words, we delete a person and attempt to search for this person, verifying that the search will not find the deleted person. So we will implement the search routine before the delete routine.

### Step 1 Development: Skeleton with Constructors

step 1  
design

In step 1, we will identify the data members and define the constructor(s) to initialize them. The key data member for the class is a structure we will use to keep track of a collection of **Person** objects. We will use an array for this data structure. Our decision to use an array is based on pedagogy. Using a **List** from JCF will simplify our development effort, but it is more important to learn how to use arrays.

We will create an array of **Person** objects in the constructor. At the time we create an array, we must declare its size. Remember that the size of an array is the maximum number of elements this array can hold. The actual number of **Person** objects stored in the array will be anywhere from zero to the size of the array.

We have two possible alternatives for specifying the size of an array. First, we can let the programmer pass the size as an argument to the constructor. Second, we can set the size to a default value. Both alternatives are useful. If the programmer has a good estimate of the number of **Person** objects to manage, she can specify the size in the constructor. Otherwise, she can use the default size by not specifying the size in the constructor. We will define two constructors to support both alternatives. This will give programmers flexibility in creating an **AddressBook** object.

If we are going to provide a constructor in which the programmer can pass the size of an array, then we need to write the constructor so it won't crash when an

invalid value is passed as an argument. What would be an invalid argument value? Since we are dealing with a collection of objects and the size of a collection cannot be negative, an argument value of less than zero is invalid. Also, even though a collection whose size is zero may make sense in theory, such a collection makes no sense in practice. Therefore, we will consider zero also as an invalid argument value. We will require an argument to a constructor to be a positive integer. We will throw an **IllegalArgumentException** for an invalid value.

step 1 code

At this point, we have only one data member—an array of **Person** objects. We will call it **entry** and set its default size to 25. There is no particular reason for selecting this size. We simply picked a number that is not too small or too big. We can change this value later if we need to.

We will define two constructors. The first constructor will call the second constructor with the value 25 (default size) as its argument. The second constructor creates an array of **Person** objects of the size passed as its parameter. Inside the second constructor, we include a temporary test output statement. The class is defined as follows:

```
/**
 * This class is designed to manage an address book that contains
 * Person objects. The user can specify the size of the address book
 * when it is created. If no size is specified, then the default size
 * is set to 25 Person objects.
 *
 * @author Dr. Caffeine
 */
class AddressBook {
 private static final int DEFAULT_SIZE = 25;
 private Person[] entry;

 public AddressBook() {
 this(DEFAULT_SIZE);
 }

 public AddressBook(int size) {
 if (size <= 0) { //invalid data value, use default
 throw new IllegalArgumentException("Size must be positive.");
 }
 entry = new Person[size];

 System.out.println("array of "+ size + " is created."); //TEMP
 }
}
```

Data members

Constructors



## 10.7 Sample Development—continued

step 1 test

To test this class, we have included a temporary output statement inside the second constructor. We will write a test program to verify that we can create an **AddressBook** object correctly. The test data are as follows:

| Step 1 Test Data |                                    |
|------------------|------------------------------------|
| Data Value       | Purpose                            |
| Negative numbers | Test the invalid data.             |
| 0                | Test the end case of invalid data. |
| 1                | Test the end case of valid data.   |
| >= 1             | Test the normal cases.             |

We will use a very simple test program:

```

/*
 Chapter 10 Sample Program: A test main program for
 verifying the step 1 AddressBook class.

 File: TestAddressBook.java
*/
import java.util.*;

class TestAddressBook { //Step 1 Test Main

 public static void main(String args[]) {

 AddressBook myBook;
 String inputStr;
 int size;

 Scanner scanner = new Scanner(System.in);

 while (true) {

 System.out.print("Array size: ");
 inputStr = scanner.next();

 if (inputStr.equalsIgnoreCase("stop")) {
 break;
 }
 }
 }
}

```



## 10.7 Sample Development—continued

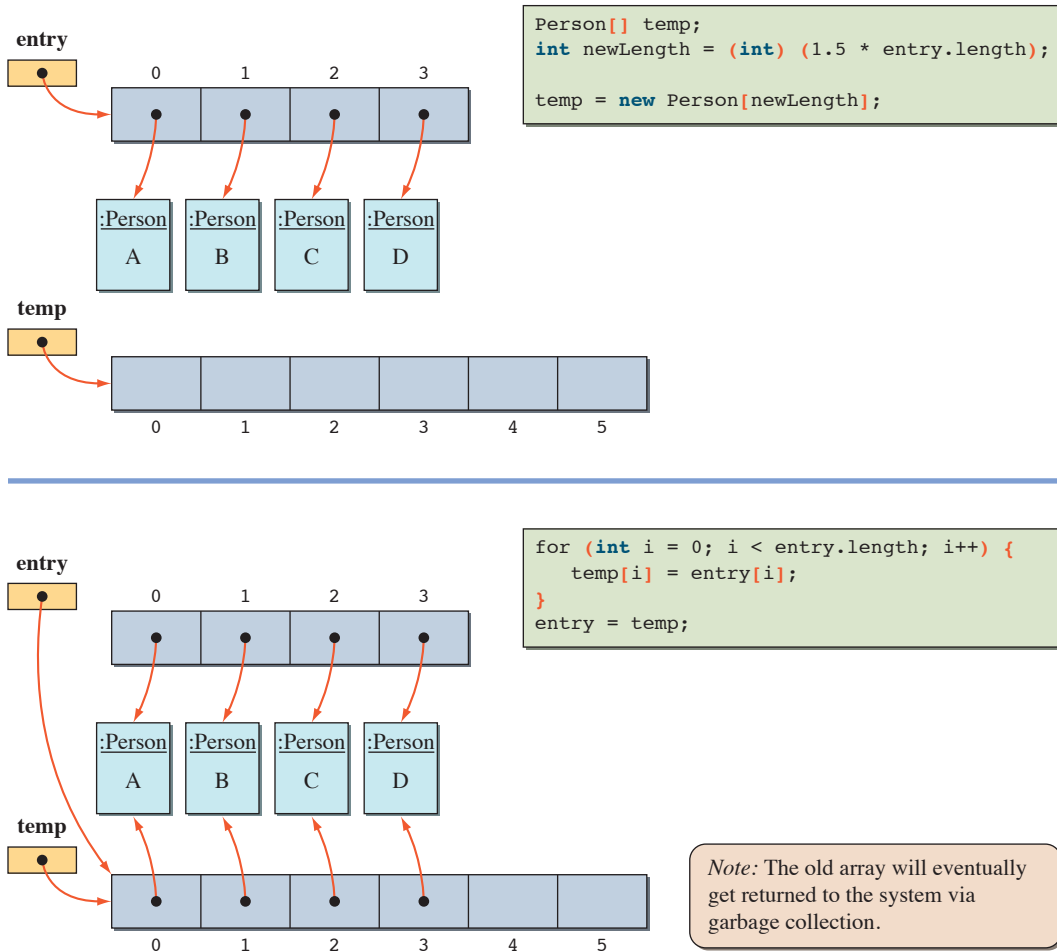

**Figure 10.16** How a new array that is 150 percent of the original array is created. The size of the original array is 4.

1.5 times larger than the original array. This size increment is just an estimate. Any value between 125 and 200 percent of the old array is reasonable. You don't want to make it too small, say, 105 percent, since that will cause the **expand** method to be called too frequently. You don't want to make it too large either, since that will likely result in wasted space. Figure 10.16 illustrates the process of creating a larger array.

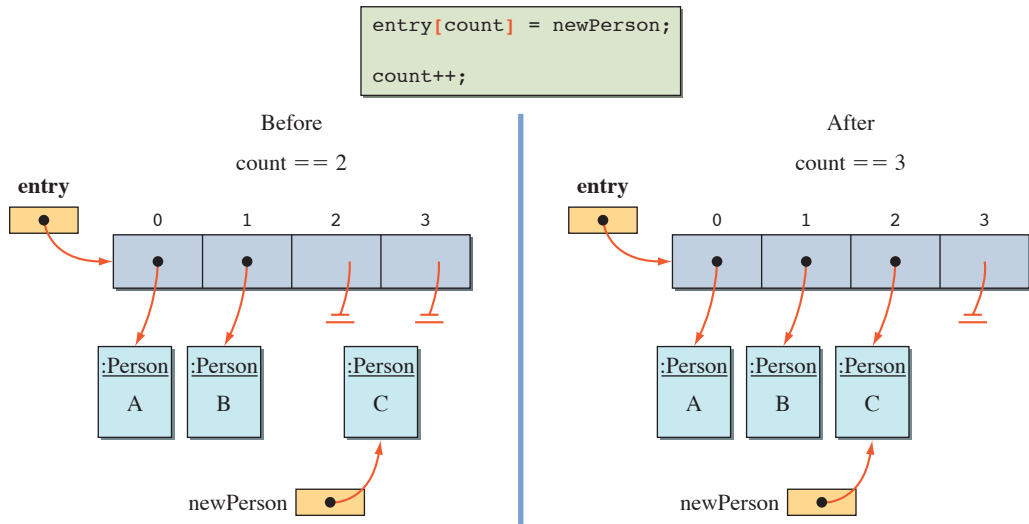

**Figure 10.17** Adding a new **Person** object to the next available location. The array length is 4.

Now let's think about how to add a **Person** object to the array. To add a new object, we need to locate a position where we can insert the object. Since we are not maintaining **Person** objects in any particular order, we will add a new person at the first available position. If we fill the positions from the low to high indices (**0, 1, 2, ...**), we can use a variable to remember the index of the next available position. Since we are using an array, the index of the next available position is also the number of **Person** objects currently in the array, so we will call this variable **count**. Figure 10.17 illustrates the **add** operation.

step 2 code

First we add a new instance variable **count** to the class:

```
//-----
// Data Members
//-----
private int count; //number of elements in the array,
 //which is also the position at which to add
 //the next Person object
```

We modify the constructor to initialize this data member:

```
public AddressBook(int size) {
 count = 0;
 //same as before
}
```

## 10.7 Sample Development—continued

(Note: Because we defined the first constructor to call the second constructor, we can implement this change by rewriting only one constructor instead of two.) The **add** method is defined as follows:

```
public void add(Person newPerson) {
 assert count >= 0 &&
 count <= entry.length;

 if (count == entry.length) { //no more space left,
 expand(); //create a new, larger array
 }

 //at this point, entry refers to a new, larger array
 entry[count] = newPerson;
 count++;
}
```

Notice the use of the assertion feature here.

Notice the use of the assertion feature. We place the **assert** statement to make sure the value of **count** is valid. The **expand** method is a new private method that creates a new, larger array.

| Design Document: The AddressBook Class |            |                                                           |
|----------------------------------------|------------|-----------------------------------------------------------|
| Method                                 | Visibility | Purpose                                                   |
| ...                                    | ...        | ...                                                       |
| expand                                 | private    | Creates a new array that is 150 percent of the old array. |

```
private void expand() {
 //create a new array whose size is 150% of
 //the current array
 int newLength = (int) (1.5 * entry.length);
 Person[] temp = new Person[newLength];

 //now copy the data to the new array
 for (int i = 0; i < entry.length; i++) {
 temp[i] = entry[i];
 }

 //finally set the variable entry to point to the new array
 entry = temp;

 System.out.println("Inside the method enlarge"); //TEMP
}
```

```

 System.out.println("Size of a new array: "
 + entry.length); //TEMP
 }

```

## step 2 test

We will write a test program to verify that a new **Person** object is added to the array correctly. In addition, we need to test that a new array 150 percent larger than the old one is created when there are no more spaces left in the array. The test data are as follows:

| Step 2 Test Data                                                                                                                   |                                                                                                                                                                                                                                        |
|------------------------------------------------------------------------------------------------------------------------------------|----------------------------------------------------------------------------------------------------------------------------------------------------------------------------------------------------------------------------------------|
| <p><b>Test Sequence</b></p> <p>Create the array of size 4.</p> <p>Add four Person objects.</p> <p>Add the fifth Person object.</p> | <p><b>Purpose</b></p> <p>Test that the array is created correctly.</p> <p>Test that the Person objects are added correctly.</p> <p>Test that the new array is created and the Person object is added correctly (to the new array).</p> |

The step 2 test program is as follows:

```

/*
 Chapter 10 Sample Program: A test main program for
 verifying the step 2 AddressBook class.

 File: TestAddressBook.java
*/

class TestAddressBook {

 public static void main(String[] args) {

 AddressBook myBook;
 Person person;

 myBook = new AddressBook(4);

 //add four Person objects
 for (int i = 0; i < 4; i++) {
 person = new Person("Ms. X" + i, 10, 'F');
 myBook.add(person);
 }

 //add the fifth person and see if
 //a new array is created

```

## 10.7 Sample Development—continued

```

 person = new Person("fifth one", 10, 'F');
 myBook.add(person);
}
}

```

Run the program several times with different sizes for the address book and verify that we get the correct results.

### Step 3 Development: Implement the search Method

step 3  
design

In the third development step, we implement the **search** method. This method can return one or more **Person** objects that meet the search criteria. We have several options for the search criteria. Since we keep track of name, age, and gender for each person, we can use any one of these values as the search criterion. In this implementation, we will use the person's name. The search routine for the other two criteria will be left as an exercise (see Exercise 14).

To implement the **search** method, we will make an assumption that the name is unique so that there will be at most one matching **Person** object. If the name is not unique, then there are two possibilities. The **search** method can return one **Person** object (among many) that matches the given name or return all **Person** objects that match the given name. We will leave the case when the name is not unique as an exercise (see Exercise 14). Notice that the **add** method we implemented in step 2 does not check the person data. In other words, there is no mechanism to disallow the addition of a **Person** object with a duplicate name. We will leave the implementation of the modified **add** method as an exercise (see Exercise 16).

There are two possible outcomes with the **search** method—a successful or an unsuccessful search. The method has to return a value by which the programmer can verify the result of the search. We will define the **search** method so that it will return a matching **Person** object if it is found and will return **null** otherwise. The search routine will start scanning the array from the first position until the desired **Person** object is found (successful search) or until no more **Person** objects are left in the array (unsuccessful search). Expressing the search routine in pseudocode, we have

```

loc = 0;
while (loc < count &&
 name of Person at entry[loc] != searchName) {
 loc++;
}
if (loc == count) {
 foundPerson = null;
} else {

```

```

 foundPerson = entry[loc];
 }
 return foundPerson;

```

## step 3 code

Translating the pseudocode to an actual method will result in the following method:

```

public Person search(String searchName) {
 Person foundPerson;
 int loc = 0;

 assert count >= 0 && count <= entry.length;

 while (loc < count &&
 !searchName.equals(entry[loc].getName())) {
 loc++;
 }

 if (loc == count) {
 foundPerson = null;
 } else {
 foundPerson = entry[loc];
 }

 return foundPerson;
}

```

## step 3 test

To test the **search** method, we will build an address book that contains five **Person** objects. We will give names **Ms.X0**, **Ms.X1**, . . . , and **Ms.X4** to them. After the address book is set up, we test various cases of the search. We test for successful and unsuccessful searches. For the successful searches, we test for the end cases and normal cases. The end cases involve searching for persons stored in the first and last positions of the array. Off-by-1 error (OBOE) is very common in processing an array, so it is very important to test these end cases.

After a successful execution, we will test the class again by changing the size of the array. One test size we should not forget to test is the end case for the array size, which is 1. Also, we need to test the cases where the array is not fully filled, such as an array of size 5 containing only two **Person** objects.

The test data are as follows:

| Step 3 Test Data                                                                                                                                                                     |                                                                                                                                                                                                                               |
|--------------------------------------------------------------------------------------------------------------------------------------------------------------------------------------|-------------------------------------------------------------------------------------------------------------------------------------------------------------------------------------------------------------------------------|
| <p><b>Test Sequence</b></p> <p>Create the array of size 5 and add five <b>Person</b> objects with unique names.</p> <p>Search for the person in the first position of the array.</p> | <p><b>Purpose</b></p> <p>Test that the array is created and set up correctly. Here, we will test the case where the array is 100 percent filled.</p> <p>Test that the successful search works correctly for the end case.</p> |



## 10.7 Sample Development—continued

|                                                                                                                                                                                                                                                                                                                                                                                                                                    |                                                                                                                                                                                                                                                              |
|------------------------------------------------------------------------------------------------------------------------------------------------------------------------------------------------------------------------------------------------------------------------------------------------------------------------------------------------------------------------------------------------------------------------------------|--------------------------------------------------------------------------------------------------------------------------------------------------------------------------------------------------------------------------------------------------------------|
| <p>Search for the person in the last position of the array.</p> <p>Search for a person somewhere in the middle of the array.</p> <p>Search for a person not in the array.</p> <p>Repeat the above steps with an array of varying sizes, especially the array of size 1.</p> <p>Repeat the testing with the cases where the array is not fully filled, say, array length is 5 and the number of objects in the array is 0 or 3.</p> | <p>Test another version of the end case.</p> <p>Test the normal case.</p> <p>Test for the unsuccessful search.</p> <p>Test that the routine works correctly for arrays of different sizes.</p> <p>Test that the routine works correctly for other cases.</p> |
|------------------------------------------------------------------------------------------------------------------------------------------------------------------------------------------------------------------------------------------------------------------------------------------------------------------------------------------------------------------------------------------------------------------------------------|--------------------------------------------------------------------------------------------------------------------------------------------------------------------------------------------------------------------------------------------------------------|

The step 3 test program is written as follows:

```

/*
Chapter 10 Sample Program: A test main program for
verifying the step 3 AddressBook class.

File: TestAddressBook.java
*/
class TestAddressBook {
 AddressBook myBook;
 Person person;

 public static void main(String[] args) {
 TestAddressBook tester = new TestAddressBook();
 tester.setupArray(5);
 tester.testSearch();
 }

 public void setupArray(int N) {
 myBook = new AddressBook(N);

 //add N Person objects
 for (int i = 0; i < N; i++) {
 person = new Person("Ms. X"+i, 10, 'F');
 myBook.add(person);
 }
 }
}

```

```

public void testSearch() {
 //test for the end case
 person = myBook.search("Ms. X2");

 if (person == null) {
 System.out.println
 ("Error: Didn't find the person it should");
 } else {
 System.out.println
 (person.getName() + " is found okay.");
 }
}
}
}

```

Notice the **TestAddressBook** class is now an instantiable main class. Since the code for testing is getting longer, it is not practical anymore to do everything in a single **main** method. For testing, we will modify the method body of **setupArray** and **testSearch** as necessary to test all other cases described in the test data table.

#### Step 4 Development: Implement the delete Method

step 4  
design

In the fourth development step, we implement the **delete** method. To delete a **Person** object, the programmer must somehow specify which **Person** object to remove from the address book. As we did with the **search** method, we will use the name of a person to specify which person to delete. Since we assume the name is unique, the **delete** method will remove at most one **Person** object. There are two possible outcomes: the specified person is removed from the address book (successful operation) and the specified person is not removed because he or she is not in the address book (unsuccessful operation). We will define the **delete** method so that it will return **true** if the operation is successful and **false** otherwise.

The removal of an element in an array of objects is done by setting the element to **null**. This will leave a "hole." We will fill this hole by replacing the removed element with the last element, as explained earlier (see Figure 10.8). This filling operation is necessary for other methods, specifically the **add** method, to work correctly.

To fill the hole, we need to know the location of the hole. To find this location, we write a private search method called **findIndex**. The method is very similar to the **search** method. The only difference is that the return value of **findIndex** is an index of an element in the array, whereas the return value of **search** is a **Person** object. By using this **findIndex** method, the **delete** method can be expressed as

```

boolean status;
int loc;

loc = findIndex(searchName);

```

## 10.7 Sample Development—continued

```

if (loc is not valid) {
 status = false;
} else { //found, pack the hole
 replace the element at index loc+1 by the last element
 at index count;

 status = true;

 count--; //decrement count,
 //since we now have one less element

 assert count is valid;
}

return status;

```

step 4 code

The private **findIndex** method will look like this:

```

private int findIndex(String searchName) {
 int loc = 0;

 assert count >=0 && count <= entry.length;

 while (loc < count &&
 !searchName.equals(entry[loc].getName())) {
 loc++;
 }

 if (loc == count) {
 loc = NOT_FOUND;
 }

 return loc;
}

```

The constant **NOT\_FOUND** is set in the data member section as

```

//-----
// Data Members
//-----

private static final int NOT_FOUND = -1;

```

By using this **findIndex** method, the **delete** method is defined as follows:

```

public boolean delete(String searchName) {
 boolean status;
 int loc;

 loc = findIndex(searchName);

 if (loc == NOT_FOUND) {

```

```

 status = false;
 } else { //found, pack the hole
 entry[loc] = entry[count-1];

 status = true;
 count--; //decrement count,
 //since we now have one less element

 assert count >= 0 && count <= entry.length;
 }
 return status;
}

```

## step 4 test

To test the **delete** method, we will build an address book that contains five **Person** objects, as before. Test cases are to delete the first person in the array, delete the last person in the array, delete someone in the middle (normal case), and try to delete a nonexistent person.

After a successful execution, we will test the class again by changing the size of an array. One test size we should not forget to test is the end case for the array size, which is 1. Also, we need to test the cases where the array is not fully filled, such as an array of size 5 containing only two **Person** objects.

The test data are as follows:

| Step 4 Test Data                                                                                                                |                                                                                                                                           |
|---------------------------------------------------------------------------------------------------------------------------------|-------------------------------------------------------------------------------------------------------------------------------------------|
| <b>Test Sequence</b><br>Create the array of size 5 and add five <b>Person</b> objects with unique names.                        | <b>Purpose</b><br>Test that the array is created and set up correctly. Here, we will test the case where the array is 100 percent filled. |
| Search for a person to be deleted next.                                                                                         | Verify that the person is in the array before deletion.                                                                                   |
| Delete the person in the array.                                                                                                 | Test that the <code>delete</code> method works correctly.                                                                                 |
| Search for the deleted person.                                                                                                  | Test that the <code>delete</code> method works correctly by checking that the value <code>null</code> is returned by the search.          |
| Attempt to delete a nonexistent person.                                                                                         | Test that the unsuccessful operation works correctly.                                                                                     |
| Repeat the above steps by deleting persons at the first and last positions.                                                     | Test that the routine works correctly for arrays of different sizes.                                                                      |
| Repeat testing where the array is not fully filled, say, an array length is 5 and the number of objects in the array is 0 or 3. | Test that the routine works correctly for other cases.                                                                                    |

## 10.7 Sample Development—continued

The step 4 test program is written as follows:

```

/*
Chapter 10 Sample Program: A test main program for
verifying the step 4 AddressBook class.

File: TestAddressBook.java
*/

class TestAddressBook {
 AddressBook myBook;
 Person person;

 public static void main(String[] args) {
 TestAddressBook tester = new TestAddressBook();
 tester.setupArray(5);
 tester.testDelete();
 }

 public void setupArray(int N) {
 myBook = new AddressBook(N);

 //add N Person objects
 for (int i = 0; i < N; i++) {
 person = new Person("Ms. X" + i, 10, 'F');
 myBook.add(person);
 }
 }

 public void testDelete() {
 //first make sure the person is in the array

 person = myBook.search("Ms. X2");

 if (person == null) {
 System.out.println("Error: Didn't find the person it should");
 } else {

 System.out.println(person.getName() + " is found okay.");

 boolean success = myBook.delete("Ms. X2");

 if (success) {

 person = myBook.search("Ms. X2");

 if (person == null) {

```



- When an array is passed to a method as an argument, only a reference to an array is passed. A copy of an array is not created. *Note:* The reference to an array we are passing is a value of an array variable, and therefore the call-by-value scheme is used here also.
- The standard classes and interfaces described or used in this chapter are
 

|            |          |
|------------|----------|
| List       | Iterator |
| ArrayList  | Map      |
| LinkedList | HashMap  |
|            | TreeMap  |
- The Java Collection Framework includes many data structure classes such as lists and maps.
- The List interface represents a linear ordered collection of objects.
- The ArrayList and LinkedList classes are two implementations of the List interface.
- The Map interface represents a collection of key-value pairs.
- The TreeMap and HashMap classes are two implementations of the Map interface.

## Key Concepts

|                               |                         |
|-------------------------------|-------------------------|
| arrays                        | arrays of objects       |
| array elements                | multidimensional arrays |
| index expression              | lists                   |
| arrays of primitive data type | maps                    |

## Chapter 10 Exercises

### Review Exercises

1. Identify problems with this code:

```
public int searchAccount(int[25] number) {
 number = new int[15];

 for (int i = 0; i < number.length; i++) {
 number[i] = number[i-1] + number[i+1];
 }
 return number;
}
```

2. Declare an array of double of size 365 to store daily temperatures for one year. Using this data structure, write a code fragment to find
  - The hottest and coldest days of the year.
  - The average temperature of each month.

- The difference between the hottest and coldest days of every month.
  - The temperature of any given day. The day is specified by two input values: month (1, . . . , 12) and day (1, . . . , 31). Reject invalid input values (e.g., 13 for month and 32 for day).
3. Repeat Exercise 2, using a two-dimensional array of double with 12 rows and each row having 28, 30, or 31 columns.
  4. Repeat Exercise 2, using an array of Month objects with each Month object having an array of double of size 28, 30, or 31.
  5. For Exercises 2 to 4, the following three data structures are used:
    - One-dimensional array of double of size 365.
    - Two-dimensional array of double with 12 rows. Each row has 28, 30, or 31 columns.
    - An array of Month objects with each Month object having an array of double of size 28, 30, or 31.

Discuss the pros and cons of each approach.

6. Suppose you want to maintain the highest and lowest temperatures for every day of the year. What kind of data structure would you use? Describe the alternatives and list their pros and cons.
7. If a car dealer's service department wants a program to keep track of customer appointments, which data structure should they choose, an array or a list? If the number of appointments the service department accepts is fixed on any given day, which data structure is appropriate? What are the criteria you use to decide which data structure to use? Explain.
8. In Figure 10.8, the last statement
 

```
person[last] = null;
```

 is significant. Show the state-of-memory diagram when the last statement is not executed.
9. Declare a two-dimensional array for the tuition table shown in Figure 10.13.
10. Suppose you want to maintain information on the location where a product is stored in a warehouse. Would you use a three-dimensional array such as location[i][j][k], where i is the warehouse number, j is the aisle number, and k is the bin number? Or would you define three classes Warehouse, Aisle, and Bin? Describe the alternatives and list their pros and cons.

### Level 1 Programming Exercises ★

11. Write a program that computes the standard deviation of  $N$  real numbers. The standard deviation  $s$  is computed according to

$$s = \sqrt{\frac{(x_1 - \bar{x})^2 + (x_2 - \bar{x})^2 + \cdots + (x_N - \bar{x})^2}{N}}$$



The variable  $\bar{x}$  is the average of  $N$  input values  $x_1$  through  $x_N$ . The program first prompts the user for  $N$  and then declares an array of size  $N$ .

12. Repeat Exercise 11, using an ArrayList.
13. Using the `payScaleTable` two-dimensional array from Section 10.4, write a program to find
  - The average pay for every grade level
  - The average pay for every step (i.e., average of every column)

You do not have to input the data values. Just assign the values to the `payScaleTable` array in the program.

14. The search method of the `AddressBook` class returns only one `Person` object. Modify the method so that it will return all `Person` objects that match the search criteria. You can use an array to return multiple `Person` objects.
15. Write new search routines for the `AddressBook` class. The search method given in the chapter finds a person with a given name. Add second and third search methods that find all persons, given an age and a gender, respectively.
16. Modify the add method of the `AddressBook` class. The method given in the chapter does not check for any duplicate names. Modify the method so that no `Person` object with a duplicate name is added to the address book.

### Level 2 Programming Exercises ★★

17. Modify the `AddressBook` class to allow the programmer to access all `Person` objects in the address book. Make this modification by adding two methods: `getFirstPerson` and `getNextPerson`. The `getFirstPerson` method returns the first `Person` object in the book. The `getNextPerson` method returns the next `Person` object if there is one. If there is no next person in the book, `getNextPerson` returns null. The `getFirstPerson` method must be called before the `getNextPerson` method is called.
18. Using a list (either an `ArrayList` or a `LinkedList`), write a fortune telling program. Repeatedly prompt the user with the message

Fortune (y/N)?

If the user enters Y, then display a randomly selected fortune from the list. If the user enters N, then stop the program. Define the class named `Fortune`. You can define and use a separate main class or include the main method in the `Fortune` class. Create the fortune list in the constructor. Include at least 10 fortunes. The following are sample fortunes you can use:

```
You will get 4.0 GPA this semester.
Happiness is programming.
Satisfaction follows hard work.
Patience is virtue.
```

19. A codon is a triplet of nucleotides that specifies a single amino acid (a protein is a sequence of amino acids). Write a program that extracts codons found in an input DNA (or RNA) sequence and stores them in an `ArrayList`. For example, if the input is `GATTCGATC`, the program stores `GAT`, `TCG`, and `ATC` in an `ArrayList`. If the length of an input string is not a multiple of 3, then ignore any leftover nucleotides. For example, if the input is `GATTCGA`, then store `GAT` and `TCG`. Output codons in the list using the for-each loop. Repeat the operation until an empty string is entered.

### Level 3 Programming Exercises ★★★

20. In addition to the `List` and `Map` interface, the third interface in the Java Collection Framework is `Set`. A `Set` is an unordered collection of objects with no duplicates. This interface models, as expected, the mathematical set. Two classes that implement the `Set` interface in JCF are `TreeSet` and `HashSet`. Here's a simple example of using `Set`:

```
Set<String> = new HashSet <String>();
set.add("ape");
set.add("bee");
set.add("ape"); //duplicate, so it won't be added
set.add("cat");
set.remove("bee");
set.remove("dog"); //not in the set, nothing happens
System.out.println("Set = " + set);
```

The output from the code will be

```
Set = [ape, cat]
```

To access the individual elements of a set, call the iterator method in the manner identical to the one we used for the `List` interface.

Rewrite the `AddressBook` class by using the `HashSet` instead of an array to maintain a collection of `Person` object.

21. Consider the following `Thesaurus` class:

```
class Thesaurus {
 //Returns all synonyms of the word as a Set
 //Returns null if there is no such word
 public java.util.Set<String> get (String word){...}

 //Returns all key words in this thesaurus as a Set
 //returns an empty set if there are no keys (if you
 //don't do anything, default behavior of the
 //underlying JCF class will handle it)
 public java.util.Set<String> keys(){...}

 //Adds 'synonym' to the synonym set of 'word'
 //Pay close attention to this method.
 public void put (String word, String synonym){...}
}
```

The `get` method returns a set of all synonyms of a given word. The `keys` method returns all key words in the thesaurus. The `put` method adds a new synonym to the given word. Make sure to handle the cases when the word already has a synonym list and when the word is added for the first time. Using this `Thesaurus` class, we can write, for example, this program:

```
class SampleMain {
 public static void main(String[] args) {
 Thesaurus t = new Thesaurus();
 t.put("fast", "speedy");
 t.put("fast", "swift");
 t.put("slow", "sluggish");

 Set<String> synonyms = t.get("fast");
 System.out.println(synonyms);
 System.out.println(t.keys());
 }
}
```

When the sample program is executed, the output will be

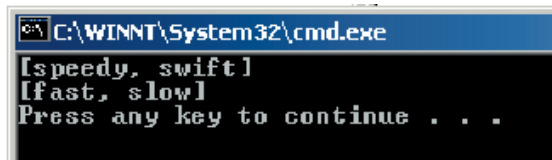

```
C:\WINNT\System32\cmd.exe
[speedy, swift]
[fast, slow]
Press any key to continue . . .
```

Implement the `Thesaurus` class, using one of the `Map` classes. The key is the word, and the value is the set of synonyms of this word.

22. Write a program that allows the user to search an element in the periodic table by the element's name or symbol. Use the `Element` class presented in Chapter 4. For this exercise, use an array. Would it be 1-D or 2-D array? How big is the size of your array? Declare the array large enough to store all 113 elements. *Note:* There's no element with atomic number 113. Elements with atomic numbers 112 and 114 do not have symbols and names. Since we have not covered file input and output (Chapter 12), create around a dozen or so `Element` objects inside the program in the following manner:

```
Element element;
element = new Element("Hydrogen", 1, "H", 1.00794, 1, 1);
//add element to the periodic table array

element = new Element("Helium", 2, "He", 4.00260, 1, 18);
//add element to the periodic table array

//and so forth
```

After the periodic table array is created and populated with elements, prompt the user with menu choices

1. Search by Name
2. Search by Symbol
3. Quit

When the user enters 1, prompt the user for the name and search the periodic table array for the element with the given name. When the user enters 2, prompt the user for the symbol and search the periodic table array for the element with the given symbol. If an element is found, display its atomic number, symbol, name, and mass. If an element is not found, then display an appropriate message. Repeat the process. Terminate the program when the user enters 3.

23. Repeat Exercise 22 using a `HashMap` or a `TreeMap` instead of an array. What would be the key of the map structure? If it is the element's name, how would you carry out the operation for search by symbol? Similarly, if the element's symbol is the key, how would you carry out the operation for search by name? Consider using two map structures, one with the symbol as the key and the other with the name as the key.

### Development Exercises

For the following exercises, use the incremental development methodology to implement the program. For each exercise, identify the program tasks, create a design document with class descriptions, and draw the program diagram. Map out the development steps at the start. Present any design alternatives and justify your selection. Be sure to perform adequate testing at the end of each development step.

24. Write a complete address book maintenance application. The user of the program has four options: Add a new person, delete a person, modify the data of a person, and search for a person by giving the name. Use the `AddressBook` class, either the original one from the chapter or the modified one from the previous exercises. You have to decide how to allow the user to enter the values for a new person, display person information, and so forth.
25. Design a currency converter class whose instance will handle conversion of all currencies. A single instance of the new currency converter class you design here will handle all currencies. Instead of having specific conversion methods such as `toDollar`, `toYen`, and so forth, the new currency converter class supports one generic conversion method called `exchange`. The method has three arguments: `fromCurrency`, `toCurrency`, and `amount`. The first two arguments are `String` and give the names of currencies. The third argument is `float`. To convert \$250 to yen, we write

```
yen = converter.exchange("dollar", "yen", 250.0);
```

To set the exchange rate for a currency, we use the `setRate` method. This method takes two arguments: The first argument is the currency name, and the second argument is the rate. For example, if the exchange rate for yen is 140 yen to \$1, then we write

```
converter.setRate("yen", 140.0);
```

Use an array to keep track of exchange rates.

26. Extend the MyJava Lo-Fat Burgers drive-through ordering system of Exercise 24 on page 302 so the program can output sales figures. For each item on the menu, the program keeps track of the sales. At closing time, the program will output the sales figure in a format similar to the following:

| Item                 | Sales Count | Total      |
|----------------------|-------------|------------|
| Tofu Burger          | 25          | \$ 87.25   |
| Cajun Chicken        | 30          | \$ 137.70  |
| ...                  |             |            |
| Today's Total Sales: |             | \$ 2761.20 |

27. Redo the watermelon projectile computing program of Exercise 31 on page 371 to output the average distance covered between each time interval. Use the expression

$$\sqrt{(x_2 - x_1)^2 + (y_2 - y_1)^2}$$

to compute the distance between two coordinate points  $(x_1, y_1)$  and  $(x_2, y_2)$ .

28. Redo the social club program of Exercise 12 on page 494. In the original program, we limit the number of clubs to 5. Remove this restriction by using an array.
29. Redo Exercise 28, but this time use one of the Java Collection Framework classes.

# Sorting and Searching

# 11

## O b j e c t i v e s

---

*After you have read and studied this chapter, you should be able to*

- Perform linear and binary search algorithms on arrays.
- Determine whether a linear or binary search is more effective for a given situation.
- Perform selection and bubble sort algorithms.
- Describe the heapsort algorithm and show how its performance is superior to that of the other two algorithms.
- Apply basic sorting algorithms to sort an array of objects, using the **Comparator** interface.
- Define the interface to specify common behavior and provide different versions of classes that implement the interface.

## Introduction



In this chapter, we cover searching and sorting. In Chapter 10, we presented a case study of maintaining an address book and described a basic searching method to locate a student, given his or her name. In this chapter, we will present a better searching algorithm called *binary search*. To apply binary search, an array must be sorted. *Sorting* is a technique to arrange elements in some order, and it is one of the fundamental operations we study in computer science. We will cover basic sorting algorithms in this chapter and an efficient recursive sorting algorithm in Chapter 15. We will use an array of integers to illustrate searching and sorting algorithms, but all the techniques we present here are equally applicable to any array of objects as well as other primitive data types. In the sample development (Section 11.4), we will extend the `AddressBook` class by adding the capability of sorting an array of `Person` objects.

## 11.1 Searching

Let's start with the problem statement for searching:

*Given a value  $X$ , return the index of  $X$  in the array, if such  $X$  exists. Otherwise, return `NOT_FOUND` ( $-1$ ). We assume there are no duplicate entries in the array.*

successful and unsuccessful searches

There are two possible outcomes in searching: Either we locate an  $X$  or we don't. We will call the first a *successful search* and the latter an *unsuccessful search*. Figure 11.1 illustrates the successful and unsuccessful searches. As obvious as this may sound, it is critical to differentiate the two because it is possible for one searching algorithm to perform superbly for successful searches, but very poorly for unsuccessful searches. When we analyze the performance of a searching algorithm, we normally derive two separate performances, one for a successful search and another for an unsuccessful search.

## Linear Search

linear search

The search technique we used earlier in the book is called a *linear search* because we search the array from the first position to the last position in a linear progression.

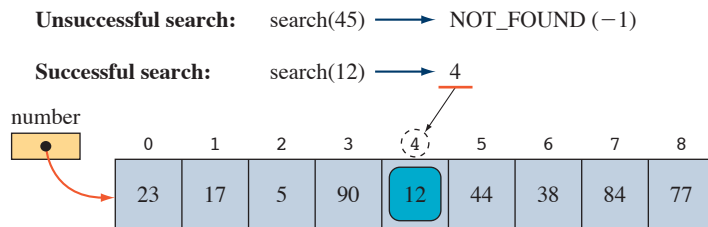

**Figure 11.1** Successful and unsuccessful searches.

The linear search is also called a *sequential search*. The linear search algorithm can be expressed as

```
public int linearSearch (int[] number, int searchValue) {
 int loc = 0;
 while (loc < number.length &&
 number[loc] != searchValue) {
 loc++;
 }
 if (loc == number.length) { //Not found
 return NOT_FOUND;
 } else {
 return loc; //Found, return the position
 }
}
```

More elements to search

searchValue is not yet found.

If the number of entries in the array is  $N$ , then there will be  $N$  comparisons for an unsuccessful search (i.e., you search for a value not in the array). In the case of a successful search, there will be a minimum of one comparison and a maximum of  $N$  comparisons. On average, there will be approximately  $N/2$  comparisons.

Is there a way to improve the linear search? If the array is sorted, then we can improve the search routine by using the binary search technique.

## Binary Search

binary search

If the values in the array are arranged in ascending or descending order, then we call the array *sorted*. In the following explanation of the binary search, we assume the array is sorted in ascending order. The crux of *binary search* is the winning strategy you apply for the Hi-Lo game. When you try to guess a secret number, say, between 1 and 100, your first guess will be 50. If your guess is HI, then you know the secret number is between 1 and 49. If your guess is LO, then you know the secret number is between 51 and 100. By guessing once, you eliminated one-half of the possible range of values from further consideration. This is the core idea of binary search.

Consider the following sorted array:



Let's suppose we are searching for 77. We first search the middle position of the array. Since this array has 9 elements, the index of the middle position is 4, so we search `number[4]`. The value 77 is not in this position. Since 77 is larger than 38 and



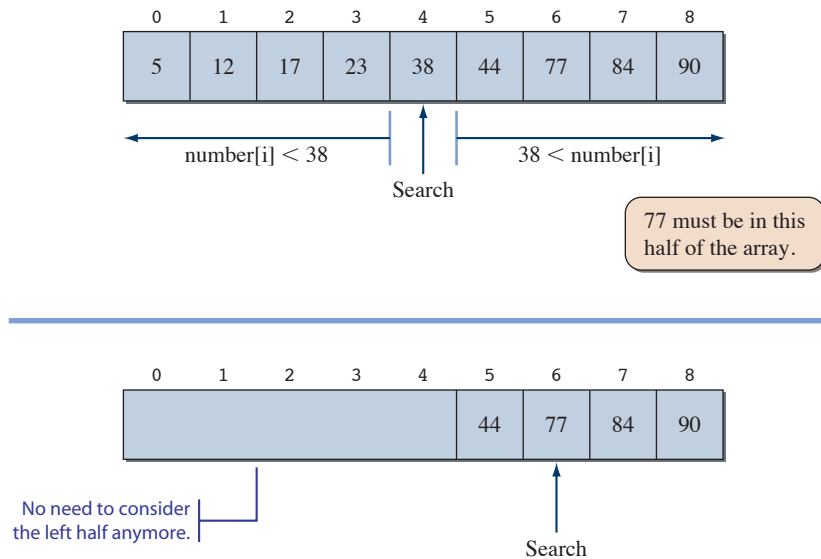

**Figure 11.2** Effect of one comparison in binary search.

the array is sorted, we know that if 77 is in the array, it must be in the right half of the array. So next we search the middle position of the right half of the array, which is position 6. Figure 11.2 illustrates the effect of making one comparison in the binary search.

The search value 77 was found after two comparisons. In contrast, the linear search would take seven comparisons to locate 77. So there is a net reduction of five comparisons. How good is the binary search in general? Let's study the worst-case situation. In the binary search, after we make one comparison, we can eliminate one-half of the array from further consideration. So the number of comparisons in the worst case is the number of times you can divide the array into halves. Suppose the original size of an array is  $N$  and the value we are searching for is not in the array. Then after one comparison, we have to search the remaining  $N/2$  elements. After two comparisons, we have to search  $N/4$  elements, and so on. The following table shows this relationship. The left column is the number of comparisons, and the right column is the number of elements we still need to search after making  $K$  comparisons.

| Number of Comparisons | Number of Elements |
|-----------------------|--------------------|
| 0                     | $N$                |
| 1                     | $N/2 = N/2^1$      |
| 2                     | $N/4 = N/2^2$      |
| ...                   | ...                |
| $K$                   | $N/2^K$            |

The maximum number of comparisons  $K$  is derived by solving the equation

$$N = 2^K$$

$$\log_2 N = K$$

This is a remarkable improvement. If the size of the original array is 2048, for example, then the unsuccessful binary search takes at most  $\log_2 2048 = 11$  comparisons, while the unsuccessful linear search takes 2048 comparisons. The difference between the two algorithms gets larger and larger as the size of an array increases.

Now let's write a binary search method. The key point in the method revolves on how to stop the search. If the search value is in the array, we will eventually locate it, so the stopping condition for the successful search is easy. What about the case for an unsuccessful search? How can we detect that there are no more elements in the array to search for? Should we use some kind of a counter? We certainly can use a counter, but we can implement the method without using any counter. To compute the middle location for the next comparison, we need two indices—low and high. The low and high indices are initialized to 0 and  $N - 1$ , respectively. The middle location is computed as

```
mid = (low + high) / 2; //the result is truncated
```

If `number[mid]` is less than the search value, then `low` is reset to `mid+1`. If `number[mid]` is greater than the search value, then `high` is reset to `mid-1`, and the search continues. Eventually, we will locate the search value or we will run out of elements to compare. We know that there are no more elements to compare when `low` becomes larger than `high`. Figure 11.3 shows how this works.

Here's the `binarySearch` method:

```
public int binarySearch (int[] number, int searchValue) {
 int low = 0,
 high = number.length - 1,
 mid = (low + high) / 2;

 while (low <= high && number[mid] != searchValue) {

 if (number[mid] < searchValue) {
 low = mid + 1;
 } else { //number[mid] > searchValue
 high = mid - 1;
 }

 mid = (low + high) / 2;
 }

 if (low > high) {
 mid = NOT_FOUND;
 }

 return mid;
}
```

Suppose we search for **45**:

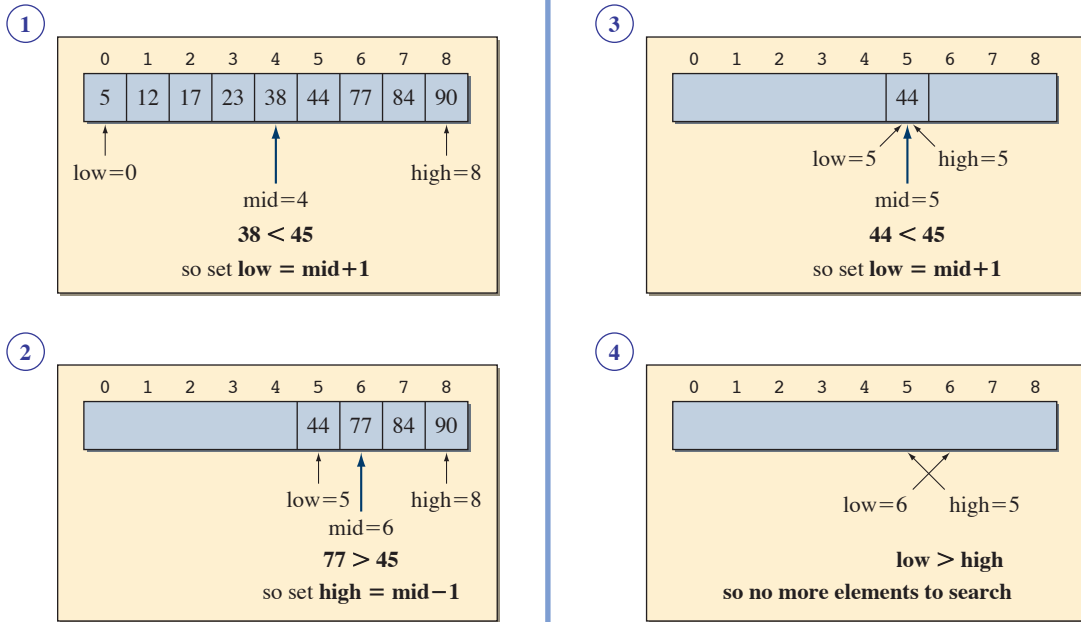

**Figure 11.3** How the unsuccessful search is terminated in the binary search routine.



1. Suppose an array contains 2048 elements. What are the least and the greatest numbers of comparisons for a successful search using linear search?
2. Repeat question 1 for a binary search.

## 11.2 | Sorting

In this section we will describe two basic sorting algorithms. A more advanced sorting algorithm will be presented in Section 11.3. Let's start with the problem statement for sorting:

*Given an array of  $N$  values, arrange the values into ascending order.*

### Selection Sort

Given a list of integers, how would you sort them? The most natural sorting algorithm for a human looks something like this:

1. Find the smallest integer in the list.
2. Cross out the number from further consideration and copy it to a new (sorted) list.
3. Repeat steps 1 and 2 until all numbers are crossed out in the list.

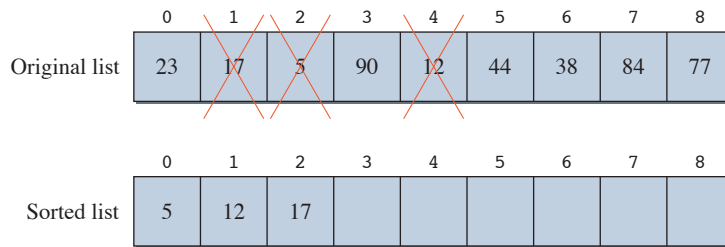

**Figure 11.4** Human sorting algorithm after three numbers are moved to the sorted list.

Figure 11.4 shows this human sorting algorithm with the first three numbers being copied to the new list.

We can write a computer program based on this sorting algorithm, but the resulting program will not be a good one. There are two problems. First, we need an extra array to keep the sorted list. This may not sound like much, but when you consider an array of, say, 10,000 elements, using a second array is very wasteful. Second, crossing out numbers is effective for humans only. We humans can see the cross marks and will not consider the numbers once they are crossed out, but in computer programs, we still have to write code to check every element to see whether it is crossed out. We can “cross out” an element by replacing it with a negative number, say,  $-1$ , if the numbers are all positive. If not, then we have to use other means to cross out an element. So crossing out the numbers does not reduce the number of comparisons in the program.

Although we do not want to implement this human sorting algorithm as is, we can derive an algorithm based on the idea of finding the smallest number in a given list and moving it to the correct position in the list. This sorting algorithm is called *selection sort*.

selection sort

sorting passes

The selection sort is comprised of *sorting passes*. Figure 11.5 shows the effect of the first pass on a sample array of  $N (= 9)$  elements. First we locate the smallest

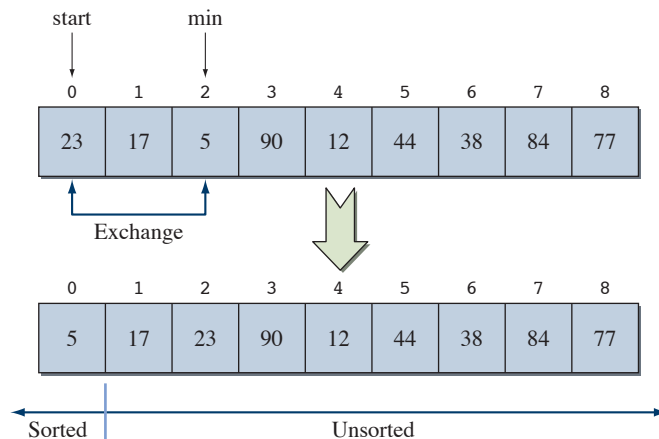

**Figure 11.5** Effect of executing the first pass in the selection sort.

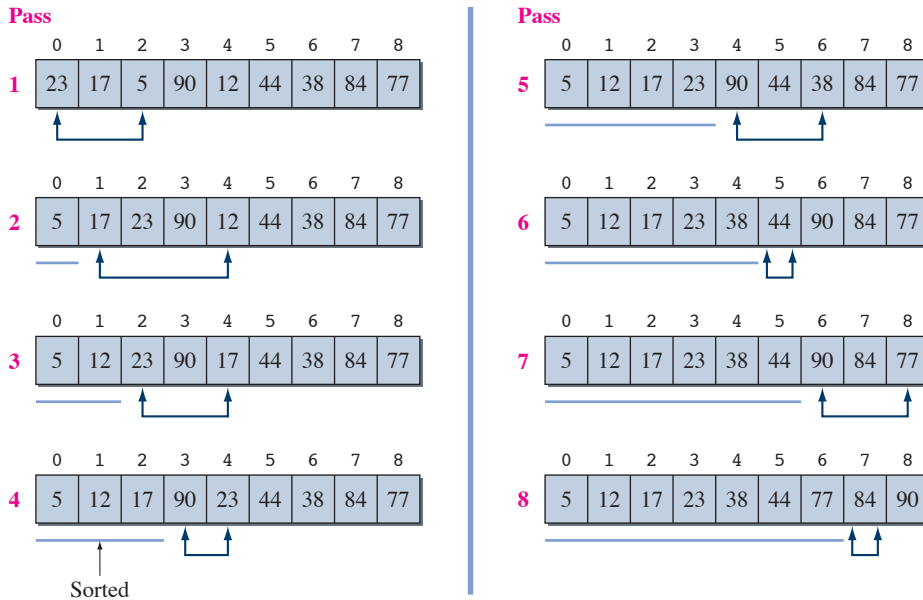

**Figure 11.6** Eight passes to sort the sample array of nine elements.

element in the array and set the index `min` to point to this element. Then we exchange `number[start]` and `number[min]`. After the first pass, the smallest element is moved to the correct position. We increment the value of `start` by 1 and then execute the second pass. We start the first pass with `start = 0` and end the last pass with `start = N-2`. Figure 11.6 shows the sequence of eight passes made to the sample array.

Here's the `selectionSort` method:

```
public void selectionSort(int[] number) {
 int minIndex, length, temp;
 length = number.length;

 for (int startIndex = 0; startIndex <= length-2;
 startIndex++){
 //each iteration of the for loop is one pass

 minIndex = startIndex;

 //find the smallest in this pass at
 //position minIndex
 for (int i = startIndex+1; i <= length-1; i++) {
 if (number[i] < number[minIndex]) minIndex = i;
 }
 }
}
```

```

//exchange number[startIndex] and number[minIndex]
temp = number[startIndex];
number[startIndex] = number[minIndex];
number[minIndex] = temp;

assert minStart(number, startIndex):
 "Error: " + number[startIndex] +
 " at position " + startIndex +
 " is not the smallest.";
}

assert isSorted(number):
 "Error: the final is not sorted";
}

```

The assertion at the end of one pass confirms that the smallest element in that pass moved to the beginning position of the pass. The `minStart` method is therefore written as follows:

```

private boolean minStart(int[] number, int startIndex) {
 for (int i = startIndex+1; i < number.length; i++) {
 if (number[startIndex] > number[i]) {
 return false;
 }
 }
 return true;
}

```

We put a second assertion at the end of the method to verify that no elements are out of place after the sorting is complete. The `isSorted` method is written as follows:

```

private boolean isSorted(int[] number) {
 for (int i = 0; i < number.length-1; i++) {
 if (number[i] > number[i+1]) {
 return false;
 }
 }
 return true;
}

```

Assertion is a very useful tool in a situation such as sorting. While developing the sorting routines, we insert a number of assertion statements to increase our confidence in the program's correctness.

## Things to Remember



Be sure to run programs with assertions enabled during the development, but disable them during the actual use. Run the program with assertions enabled with

```
java -ea <main class>
```

## Hints, & Tips, Pitfalls



We use assertions to find coding error. But what will happen when the code we write for assertions, such as at the **minStart** method used in the selection sort routine, is wrong? How can we assert that **minStart** is correct? We do not want to write assertions for assertions! One possibility is to create a data set that is correct and to run the **minStart** method against these data to test for their validity. The use of assertions is merely an aid, not a fail-safe way to find errors.

Let's analyze the selection sort algorithm. In analyzing different sorting algorithms, we normally count two things: the number of comparisons and the number of data movements (exchanges). We will show you how to count the number of comparisons here. Counting the number of data movements is left as Exercise 4. Keep in mind that the analysis we provide in this chapter is an informal one. A detailed analysis is beyond the scope of this book, so we will give only a taste of the formal analysis.

The selection sort has one comparison (the if statement inside the nested-for loop), so we can easily count the total number of comparisons by counting the number of times the inner loop is executed. For each execution of the outer loop, the inner loop is executed  $\text{length} - \text{start}$  times. The variable `start` ranges from 0 to  $\text{length}-2$ . So the total number of comparisons is computed by finding the sum of the right column in the following table:

| Start      | Number of Comparisons<br>(Length – Start) |
|------------|-------------------------------------------|
| 0          | length                                    |
| 1          | length – 1                                |
| 2          | length – 2                                |
| ...        | ...                                       |
| length – 2 | 2                                         |

The variable length is the size of the array. If we replace length with  $N$ , the size of the array, then the sum of the right column is

$$\begin{aligned} N + (N - 1) + (N - 2) + \cdots + 2 &= \sum_{i=2}^N i = \left( \sum_{i=1}^N i \right) - 1 \\ &= \frac{N(N + 1)}{2} - 1 = \frac{N^2 + N - 2}{2} \cong N^2 \end{aligned}$$

The total number of comparisons is approximately the square of the size of an array. This is a quadratic function, so the number of comparisons grows very rapidly as the size of an array increases. Is there a better sorting algorithm? The answer is yes.

### Bubble Sort

The effect of one pass of the selection sort is the movement of the smallest element to its correct position. Since an array gets sorted only by moving the elements to their correct positions, the whole sorting routine will complete sooner if we increase the number of data movements. In the selection sort, we make one exchange per pass. If we could move more elements toward their correct positions in one pass, we could complete the sorting sooner than the selection sort. The bubble sort is one such algorithm that increases the number of data movements for the same number of comparisons as the selection sort makes.

The key point of the bubble sort is to make pairwise comparisons and to exchange the positions of the pair if they are out of order. Figure 11.7 shows the effect of pairwise comparisons in the first pass of the bubble sort. After the first pass, the largest element, 90, has moved to its correct position in the array. This is the guaranteed effect of one pass. In addition, we notice that many other elements have moved toward their correct positions, as bubbles move toward the water's surface.

In the worst case, the bubble sort will make  $N - 1$  passes, so the worst-case performance is the same as that for the selection sort. However, in the average case, we can expect a better performance from the bubble sort. The bubble sort exhibits two properties:

- After one pass through the array, the largest element will be at the end of the array.
- During one pass, if no pair of consecutive entries is out of order, then the array is sorted.

Using these properties, we can express the bubbleSort method in pseudocode:

This **while** loop performs at most  $N - 1$  passes for an array with  $N$  elements. The loop will terminate when there are no exchanges in one pass.

```
bottom = number.length - 2;
exchanged = true;
while (exchanged) { //continue if the exchange is made
 //do one pass of sorting
 exchanged = false; //reset the variable
```



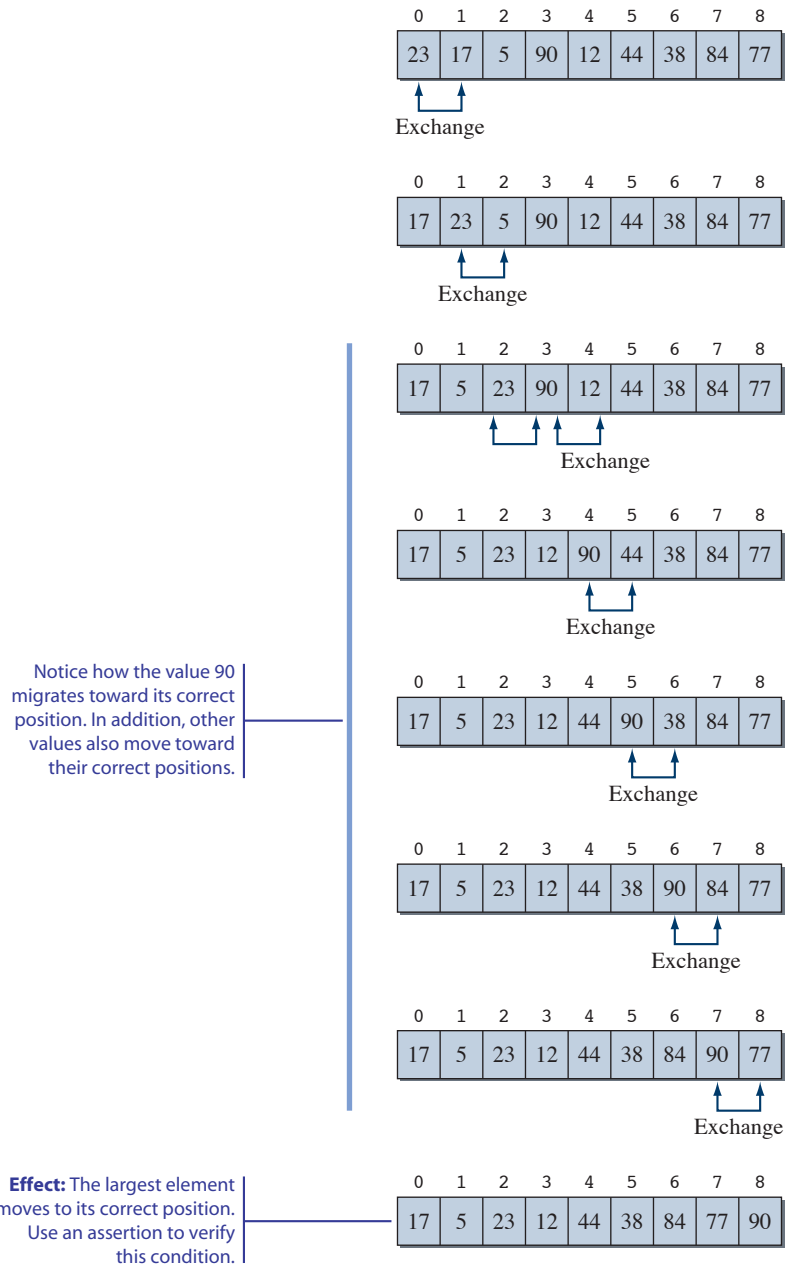

**Figure 11.7** Effect of executing the first pass in the bubble sort.

One pass of  
bubble sort



```

for (int i = 0; i <= bottom; i++) { //pairwise comparison
 if (number[i] > number[i+1]) {
 //the pair is out of order
 exchange them;

 exchanged = true; //an exchange is made
 }
}
//one pass is done, decrement the bottom index by 1
bottom--;
}

```

Translating the pseudocode into an actual method, we have

```

public void bubbleSort(int[] number) {
 int temp, bottom;
 boolean exchanged = true;

 bottom = number.length - 2;
 while (exchanged) {
 exchanged = false;
 for (int i = 0; i <= bottom; i++) {
 if (number[i] > number[i+1]) {
 temp = number[i]; //exchange
 number[i] = number[i+1];
 number[i+1] = temp;
 exchanged = true; //exchange is made
 }
 }
 assert maxBottom(number, bottom):
 "Error: " + number[bottom] +
 " at position " + bottom +
 " is not the largest.";
 bottom--;
 }
 assert isSorted(number):
 "Error: the final is not sorted";
}

```

Assert the element at position **bottom** is the largest among elements from position **0** to **bottom**.



The `maxBottom` method verifies that the largest element among elements from position 0 to `bottom` is at position `bottom`. The method is written as follows:

```

private boolean maxBottom(int[] number, int lastIndex) {
 for (int i = 0; i < lastIndex; i++) {

```

```

 if (number[lastIndex] < number[i]) {
 return false;
 }
 }
 return true;
}

```

On average, we expect the bubble sort to finish sorting sooner than the selection sort, because there will be more data movements for the same number of comparisons, and there is a test to exit the method when the array gets sorted. The worst case of the bubble sort happens when the original array is in descending order. Notice that if the original array is already sorted, the bubble sort will perform only one pass whereas the selection sort will perform  $N - 1$  passes.



1. Show the result of the second pass of bubble sort applied to the array at the bottom of Figure 11.7.
2. For an array with  $N$  elements, what is the least number of comparisons the bubble sort will execute?

### 11.3 Heapsort

Selection and bubble sorts are two fundamental sorting algorithms that take approximately  $N^2$  comparisons to sort an array of  $N$  elements. One interesting sorting algorithm that improves this performance to approximately  $1.5N \log_2 N$  is *heapsort*. We will describe the heapsort algorithm and analyze its performance in this section.

heapsort

heap

root node

The heapsort algorithm uses a special data structure called a *heap*. A heap consists of nodes, which contain data values, and edges, which link the nodes. Figure 11.8 shows a sample heap. We use integers as data values for the examples in this section. The topmost node is called the *root node* of a heap. Nodes in a heap

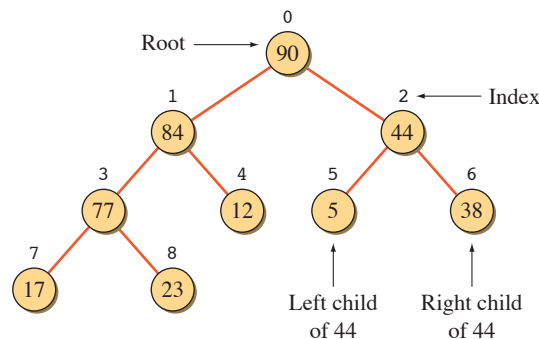

**Figure 11.8** A sample heap that includes nine nodes.

left and right children

heap constraints

are indexed 0, 1, 2, and so forth in the top-to-bottom, left-to-right order, starting from the root. A node in a heap has zero, one, or two *children*. The children of a node are distinguished as the node's *left* and *right children*. If a node has only one child, then it is the left child of the node.

A heap must satisfy these two constraints:

1. *Structural constraint*. Nodes in a heap with  $N$  nodes must occupy the positions numbered 0, 1,  $\dots$ ,  $N - 1$ . Figure 11.9 shows examples of nonheaps that violate the structural constraint.
2. *Value relationship constraint*. A value stored in a node must be larger than the maximum of the values stored in its left and right children. Figure 11.10 shows examples of nonheaps that violate the value relationship constraint.

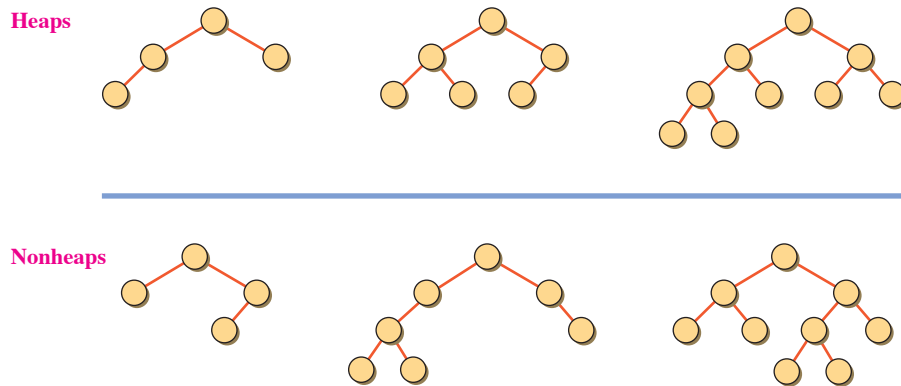

**Figure 11.9** Sample heaps and nonheaps that violate the structural constraint.

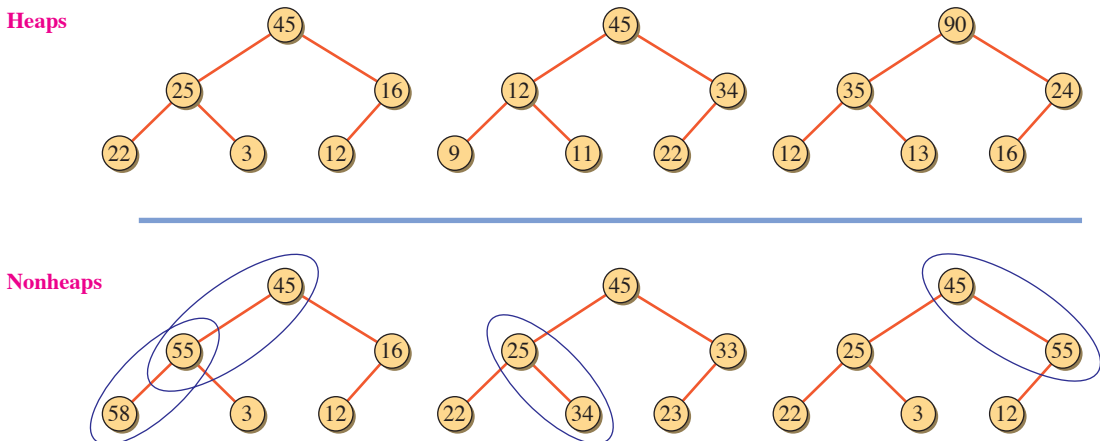

**Figure 11.10** Sample heaps and nonheaps that violate the value relationship constraint. Violations are indicated by blue ellipses.

heapsort  
phases

How can we use the heap structure to sort  $N$  elements? Heapsort is carried out in two phases:

1. *Construction phase*. Construct a heap given  $N$  elements.
2. *Extraction phase*. Pull out the value in the root successively, creating a new heap with one less element after each extraction step.

We will begin the description of heapsort from the extraction phase. Consider the heap shown in Figure 11.8. Since every node in the heap satisfies the value relationship constraint, we can conclude that the value in the root node is the largest among the values stored in the heap. Now, after we remove the value 90 from the heap, we must create a new heap that has one less element. We can build such a heap by first moving the last element (value 23 in the figure) to the root position. With the value 23 in the root position, we have met the structural constraint for the heap with eight elements. However, the value relationship constraint is not met. The violation occurs because 23 is smaller than the larger of its two children. By swapping 84 and 23, the violation is eliminated. Since the value 23 is now at a new location, we must check again if the violation occurs at this position. It does, because 77 is larger than 23, so we swap again. We repeat the process until either there are no more children to consider or the value moved into a new position meets the value relationship constraint. We will call this process a *rebuild step*. One rebuild step is illustrated in Figure 11.11.

rebuild step

Using a heap with  $N$  elements, we can sort the given  $N$  elements by performing the rebuild steps  $N - 1$  times. Figure 11.12 illustrates the rebuild steps for the sample heap. Notice how the array for the sorted list is filled from the end. All we have to do now is to figure out how to build a heap from a given unsorted list of  $N$  elements. Let's study the construction phase of the algorithm.

We will illustrate the construction phase with the following unsorted nine elements:

23, 17, 5, 90, 12, 44, 38, 84, 77

If we assign the given numbers to a heap structure in ascending index order, we have the heap structure shown in Figure 11.13. This heap structure is not truly a heap because it violates the value relationship constraint. The construction phase will eliminate any violations of the value relationship constraint. The key concept for the construction phase is the rebuild step we used in the extraction phase. We will build a complete heap in a bottom-up fashion. We start out with a small heap and gradually build bigger and bigger heaps until the heap contains all  $N$  elements. Figure 11.14 shows the sequence of rebuild steps. The triangles indicate where the rebuild steps are applied. In the extraction step, the rebuild step is always applied to the root node. In the construction step, each rebuild step is applied successively, beginning with the node at index  $\lfloor (N - 2)/2 \rfloor$  and ending with the node at index 0 (i.e., the root node).

Now let's consider how we can implement this algorithm in Java. We must first decide how to represent a heap. Among the possible alternatives, an array is very effective in representing a heap.

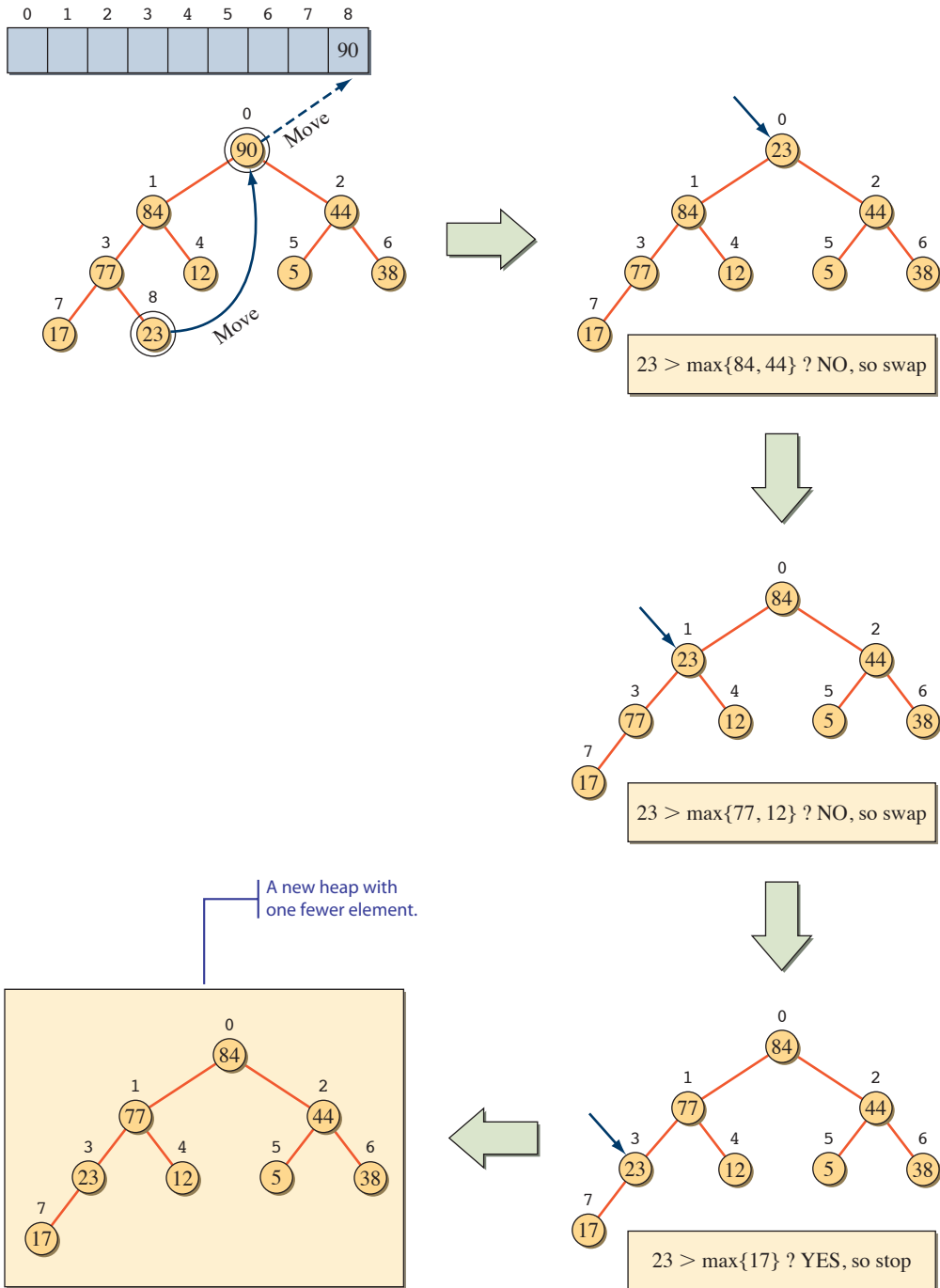

**Figure 11.11** One rebuild step after the value 90 is pulled out from the heap. The net result of a single rebuild step is a new heap that contains one fewer element.

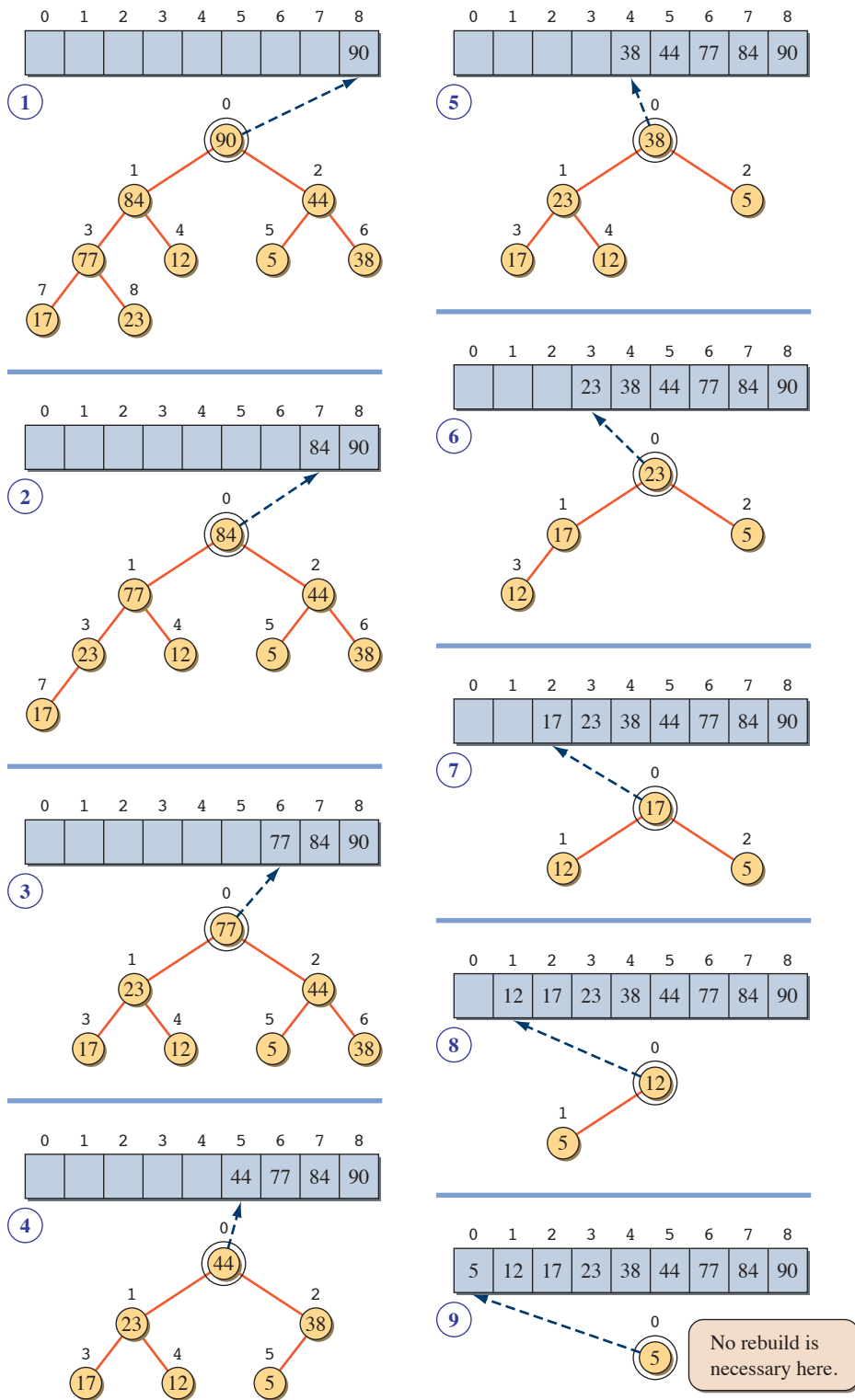

**Figure 11.12** Eight rebuild steps to sort a heap with nine elements.

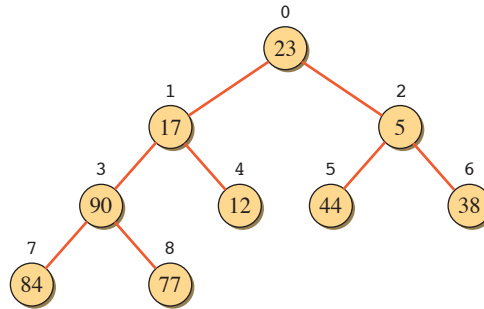

**Figure 11.13** A heap structure with given numbers assigned in ascending index order.

Figure 11.15 shows the correspondence between the heap and the array representation. An important aspect in deciding which data structure to use is the ease of locating a given node's left and right children. With an array implementation, we can locate any node's left and right children easily. A node with index  $I$  has its left child at index  $2I + 1$  and its right child at index  $2I + 2$ .

Since the heapsort algorithm is more involved than the insertion or bubble sort algorithm, we will put all the necessary code in a single class called `Heap` to provide a complete picture. To simplify our implementation so we can focus on the algorithm, we will allow only integers. You can modify the class to allow any objects to be sorted; see Exercise 16 at the end of this chapter. The following code illustrates how to use the `Heap` class:

```

int[] number = { 90, 44, 84, 12, 77, 23, 38, 5, 17 };
int[] sortedList;

Heap heap = new Heap();

heap.setData(number); //assign the original list

sortedList = heap.sort(); //sort the list

for (int i = 0; i < sortedList.length; i++) { //print out
 System.out.print(" " + sortedList[i]); //the sorted
} //list

```

The `Heap` class will include two arrays as its data members: one to implement a heap and another to store the sorted list.

```

/**
 * This class implements the heapsort algorithm. This class
 * can sort only integers.
 */
class Heap {

```



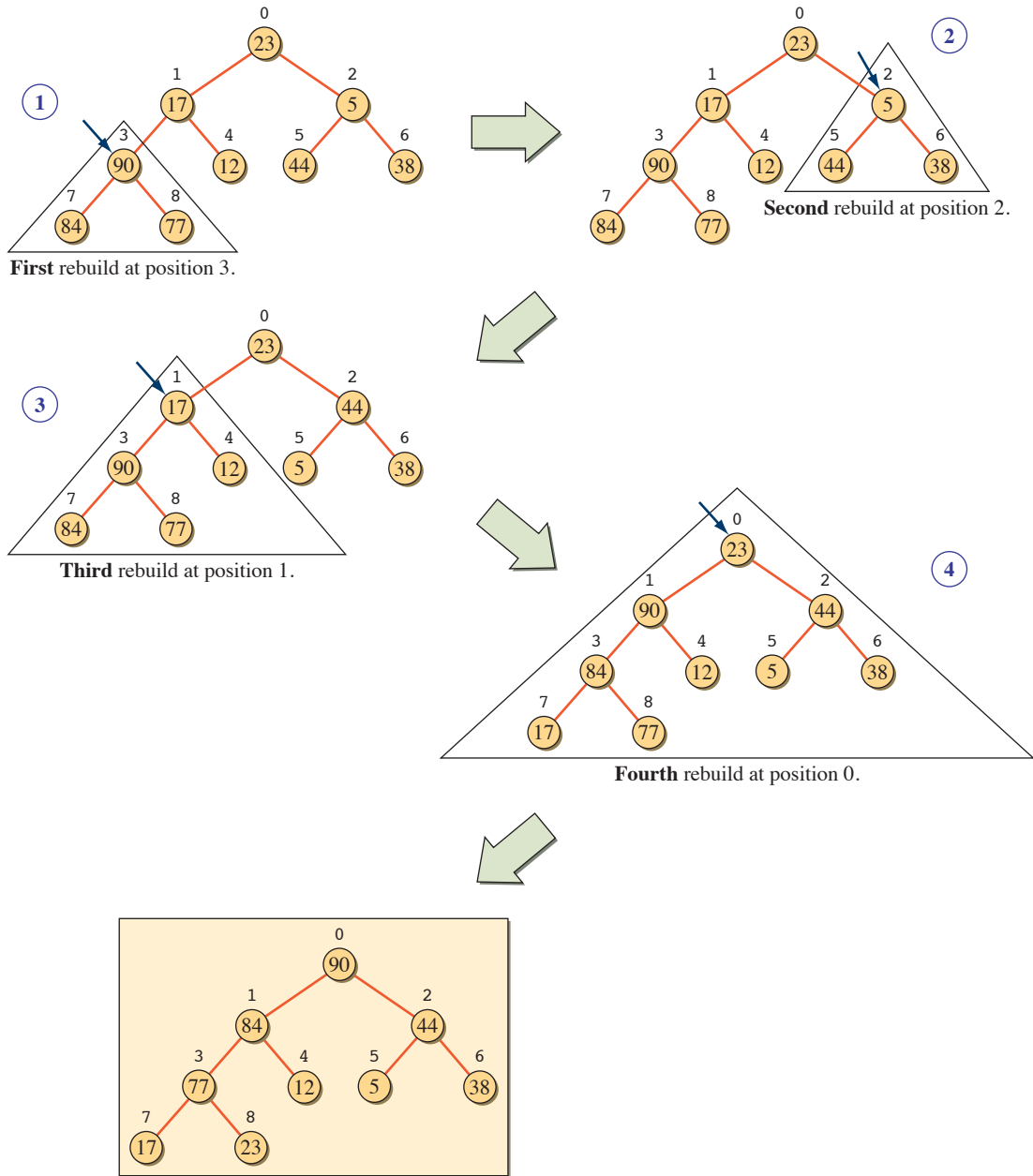

**Figure 11.14** Sequence of rebuild steps applied in the construction phase. Rebuild steps are carried out at index positions 3, 2, 1, and 0.

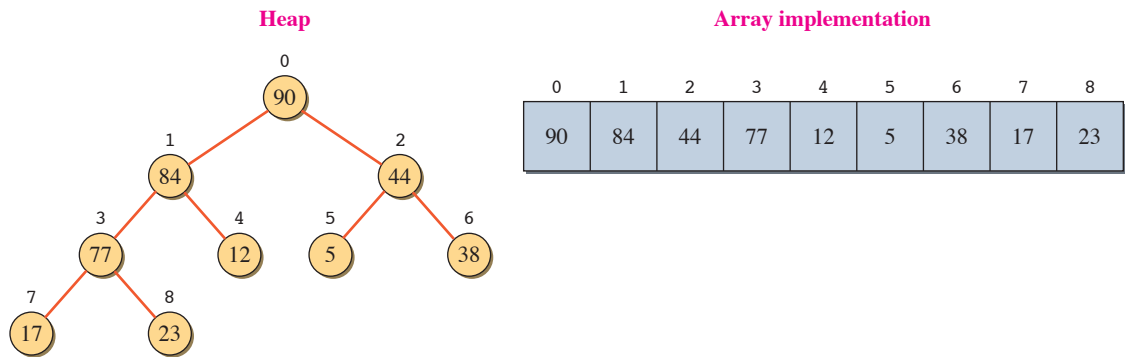

**Figure 11.15** A sample heap and the corresponding array implementation.

```

/**
 * Implements the heap
 */
private int[] heap;

/**
 * Stores the sorted list
 */
private int[] sortedList;

// methods come here
...
}

```

Now let's look at the methods. The `setData` method initializes the two data members as follows:

```

public void setData(int[] data) {
 heap = new int[data.length];
 sortedList = new int[data.length];

 for (int i = 0; i < data.length; i++) {
 heap[i] = data[i];
 }
}

```

Notice that we copy the contents of the `data` array to the `heap` array. If we simply assign the parameter to the data member `heap` as

```
heap = data;
```

then all we are doing is setting two names referring to the same object. Since we do not want to change the original `data` array, we make a separate copy.

The sort method calls two private methods that implement the two phases of the heapsort algorithm:

```
public int[] sort() {
 construct(); //perform the construction phase
 extract(); //perform the extraction phase
 return sortedList;
}
```

Here's the construct method:

```
private void construct() {
 int current, maxChildIndex;
 boolean done;

 for (int i = (heap.length-2) / 2; i >= 0; i--) {
 current = i;
 done = false;

 while (!done) { //perform one rebuild step
 //with the node at index i

 if (2*current+1 > heap.length-1) {
 //current node has no children, so stop
 done = true;
 } else {
 //current node has at least one child,
 //get the index of larger child
 maxChildIndex
 = maxChild(current, heap.length-1);

 if (heap[current] < heap[maxChildIndex]) {
 //a child is larger, so swap and continue
 swap(current, maxChildIndex);
 current = maxChildIndex;
 } else { //the value relationship constraint
 //is satisfied, so stop
 done = true;
 }
 }
 }
 }

 assert isValidHeap(heap, i, heap.length-1):
 "Error: Construction phase is not working " +
 "correctly";
}
```

```

 testPrint(heap.length); //TEMP
 }

```

The `isValidHeap` method is used to assert that elements from position `start` to position `end` form a valid heap structure. Here's the method:

```

private boolean isValidHeap(int[] heap,
 int start, int end) {
 for (int i = start; i < end/ 2; i++) {
 if (heap[i] < Math.max(heap[2*i+1], heap[2*i+2])) {
 return false;
 }
 }
 return true;
}

```

And here's the `extract` method:

```

private void extract() {
 int current, maxChildIndex;
 boolean done;

 for (int size = heap.length-1; size >= 0; size--) {
 //remove the root node data
 sortedList[size] = heap[0];

 //move the last node to the root
 heap[0] = heap[size];

 //rebuild the heap with one fewer element
 current = 0;
 done = false;

 while (!done) {
 if (2*current+1 > size) {
 //current node has no children, so stop
 done = true;
 } else {
 //current node has at least one child,
 //get the index of larger child
 maxChildIndex = maxChild(current, size);

 if (heap[current] < heap[maxChildIndex]) {
 //a child is larger, so swap and continue
 swap(current, maxChildIndex);
 current = maxChildIndex;
 }
 }
 }
 }
}

```

```

 } else { //value relationship constraint
 //is satisfied, so stop
 done = true;
 }
 }
}

assert isValidHeap(heap, i, heap.length-1):
 "Error: Construction phase is not working " +
 "correctly";
testPrint(size); //TEMP
}
}
}

```

A number of methods are shared by both methods. The `maxChild` method returns the index of a node's left or right child, whichever is larger. This method is called only if a node has at least one child. The first parameter is the index of a node, and the second parameter is the index of the last node in a heap. The second parameter is necessary to determine whether a node has a right child. The method is defined as follows:

```

private int maxChild(int location, int end) {
 int result, leftChildIndex, rightChildIndex;

 rightChildIndex = 2*location + 2;
 leftChildIndex = 2*location + 1;

 //Precondition:
 // Node at 'location' has at least one child
 assert leftChildIndex <= end:
 "Error: node at position " + location +
 "has no children.";

 if (rightChildIndex <= end &&
 heap[leftChildIndex] < heap[rightChildIndex]) {
 result = rightChildIndex;
 } else {
 result = leftChildIndex;
 }

 return result;
}

```

The other two methods shared by the `construct` and `extract` methods are `swap` and `testPrint`. The `swap` method interchanges the contents of two array elements, and the `testPrint` method outputs the heap array for verification and debugging purposes. You can comment out the calls to `testPrint` from the `construct` and `extract`

methods after you verify that the algorithm is implemented correctly. Here are the two methods:

```
private void swap (int loc1, int loc2) {
 int temp;

 temp = heap[loc1];
 heap[loc1] = heap[loc2];
 heap[loc2] = temp;
}

private void testPrint(int limit) {
 for (int i = 0; i < limit; i++) {
 System.out.print(" " + heap[i]);
 }

 System.out.println(" ");
}
```

There are several improvements we can make to the simple Heap class we provided here. These improvements are left as Exercise 16.

### Performance

How good is the heapsort? We mentioned in Section 11.2 that the performances of both selection and bubble sort algorithms are approximately  $N^2$  comparisons for sorting  $N$  elements. The heapsort algorithm is substantially more complex in design and implementation than the other two basic sorting algorithms. Is the extra complexity worth our effort? The answer is yes. The performance of the heapsort algorithm is approximately  $1.5N \log_2 N$  comparisons for sorting  $N$  elements. This is a remarkable improvement. Consider the difference between the two performances for large  $N$ . For example, to sort 100,000 elements, the selection or bubble sort requires 10,000,000,000 comparisons, while the heapsort requires only  $1.5 \cdot 100,000 \log_2 100,000 \approx 2,491,695$  comparisons. If a single comparison takes 1 microsecond ( $\mu\text{s}$ ) (one millionth second), then the selection or bubble sort takes about 2.8 hours while the heapsort takes only about 2.492 seconds. (*Note:* The sorting operation itself may complete in a few seconds, but printing out the sorted 100,000 elements would take much longer.)

Let's study how the performance of  $1.5N \log_2 N$  comparisons is derived. What we need to count is the number of comparisons made during the rebuild steps in both the construction and extraction phases. During the extraction phase, the rebuild process is carried for  $N - 1$  times. If we let  $K$  be the maximum number of comparisons required in one rebuild step, then the total number of comparisons will be  $(N - 1)K$ . In one rebuild step, we start comparing the value in the root node with the larger of its two children. If the value relationship constraint is not violated, the rebuild step terminates immediately. If there is a violation, we make a swap and continue. This compare-and-swap operation is carried out until either the value relationship constraint is met or there are no more nodes to compare. This means that

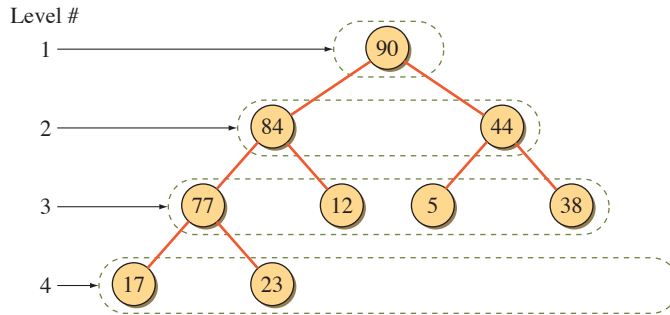

**Figure 11.16** A sample heap with depth = 4, which is defined to be the largest level of all nodes in a heap.

the maximum number of comparisons  $K$  is derived by finding out how many times the value relationship constraint violation can occur before the nodes to compare are exhausted.

level

Consider the heap shown in Figure 11.16. We define the *level* of a node in a heap to be the number of nodes in the path from the root to this node. For example, the level of node 44 in the sample heap is 3. The *depth* of a heap is defined to be the largest level of the nodes in the heap. The depth of the sample heap is therefore 4. Since the compare-and-swap operation starting from the root can never continue comparing beyond the largest level of the nodes, the depth of a heap is the value we seek for  $K$ . Thus, the value for  $K$  is derived by finding the depth of a heap with  $N$  elements.

depth

At level 1, there is one node. At level 2, there are two nodes. Since a node at level  $i$  can have at most 2 children, the maximum number of nodes at level  $i + 1$  is double the number of nodes at level  $i$ . Assuming the maximum number of nodes at all levels, the number of elements at level  $i$  is  $2^{i-1}$ , so the maximum total number of nodes in a heap of depth  $K$  is

$$\sum_{i=1}^K 2^{i-1} = 2^K - 1$$

Because a heap must satisfy the structural constraint, we know the relationships

$$\begin{aligned} 2^{K-1} - 1 < N \leq 2^K - 1 \\ 2^{K-1} < N + 1 \leq 2^K \end{aligned}$$

will hold. By applying  $\log_2$  to all terms, we have

$$K - 1 < \log_2(N + 1) \leq K$$

so

$$K = \lceil \log_2(N + 1) \rceil$$

Finally, the total number of comparisons for the extraction phase is

$$(N - 1)K = N \cdot \lceil \log_2(N + 1) \rceil \approx N \log_2 N$$

The construction phase will perform approximately  $N/2$  rebuild steps. Each rebuild step will take no more than  $K$  comparisons, so the total number of comparisons for the construction phase is

$$\frac{N}{2} \log_2 N$$

The total number of comparisons for both phases is therefore

$$1.5N \log_2 N$$



1. The following structure violates the value relationship constraints. Use the construction phase routine of the heapsort to eliminate the violations.

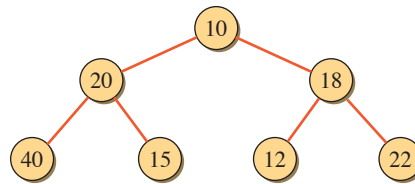

2. Identify all violations on structural and value relationship constraints in the following structure.

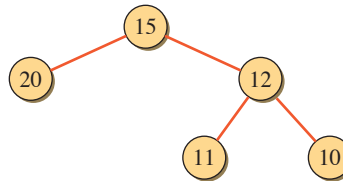

### Sorting an AddressBook

Let's put our basic knowledge of sorting algorithms into practice. In Chapter 10 we presented the **AddressBook** class that maintains a collection of **Person** objects. We will extend the **AddressBook** class by incorporating a sorting routine. The new **AddressBook** class will include a method that sorts the **Person** objects in alphabetical order of their names or in ascending order of their ages.

Instead of going through the development steps, we will discuss three different implementations to illustrate various techniques of Java programming. The three classes are named **AddressBookVer1**, **AddressBookVer2**, and **AddressBookVer3**. We will



## 11.4 Sample Development—continued

define an interface and make these three classes implement the defined interface. We have already dealt with interfaces, for example, the **List** and **Map** interfaces in Chapter 10. As we learned in that chapter, the interface defines a behavior, and if a class implements the interface, we can be certain that the instances of the class will support this behavior. Making classes implement the same interface is therefore a way to enforce consistency among the implementation classes. Because all three classes **AddressBookVer1**, **AddressBookVer2**, and **AddressBook3** implement the same interface, they will exhibit the same behavior, and we can therefore use them interchangeably in our programs.

The interface is named **AddressBook**, and we will include the public methods that must be supported by all versions. Collectively these public methods define the behavior common to all implementing classes. Public methods in the interface must not have any method body, only the method prototype followed by a semicolon. Here's the **AddressBook** interface:

```

/*
 Chapter 11 Sample Program: AddressBook Interface
 File: AddressBook.java
*/
interface AddressBook {
 public void add(Person newPerson);
 public boolean delete(String searchName);
 public Person search(String searchName);
 public Person[] sort(int attribute);
}

```

The driver program to test the working of **AddressBook** is defined as follows:

```

/*
 Chapter 11 Sample Program: Test program to verify the
 the AddressBook and Person classes
 File: TestAddressBookSorting.java
*/

```

```

import javax.swing.*;

class TestAddressBookSorting {

 public static void main(String[] args) {

 TestAddressBookSorting tester = new TestAddressBookSorting();
 tester.start();
 }

 private void start() {
 String[] name = {"ape", "cat", "bee", "bat", "eel",
 "dog", "gnu", "yak", "fox", "cow",
 "hen", "tic", "man"};

 Person p;

 AddressBook ab;

 Scanner scanner = new Scanner(System.in);

 System.out.print("Version #: ");
 int version = scanner.nextInt();

 switch (version) {
 case 1: ab = new AddressBookVer1(); break;
 case 2: ab = new AddressBookVer2(); break;
 case 3: ab = new AddressBookVer3(); break;
 default: ab = new AddressBookVer1(); break;
 }

 for (int i = 0; i < name.length; i++) {
 p = new Person(name[i], random(10, 50),
 random(0,1)==0?'M':'F');

 //note: random(0,1) == 0 ? 'M':'F'
 // means if (random(0,1) == 0) then 'M' else 'F'
 ab.add(p);
 }

 Person[] sortedlist = ab.sort(Person.AGE);

 for (int i = 0; i < sortedlist.length; i++) {
 System.out.println(sortedlist[i].toString());
 }

 System.out.println(" ");

 sortedlist = ab.sort(Person.NAME);

 for (int i = 0; i < sortedlist.length; i++) {
 System.out.println(sortedlist[i].toString());
 }
 }
}

```



## 11.4 Sample Development—continued

```
private int random(int low, int high) {
 return (int) Math.floor(Math.random() * (high - low + 1))
 + low;
}
}
```

random

## Version 1

In describing the basic sorting algorithms, we limit the data values to integers. This makes the comparison test easy. We write something like this:

```
if (number[i] < number[i+1]) {
 //do something...
} else {
 //do something else...
}
```

But how do we compare **Person** objects? We cannot say

```
Person p1 = new Person("Jack", 18, 'M');
Person p2 = new Person("Jill", 19, 'F');
if (p1 < p2) {
 ...
}
```

Cannot compare **Person** objects like this, because it does not make sense. Comparison operators other than equal (==) do not apply for objects.

because the comparison operators such as `<`, `>`, and others except the equal operator are meaningful only for comparing primitive data values. To be able to compare **Person** objects, we need to modify the class. Let's suppose that we want to compare two **Person** objects based on either their names or their ages. First we add the following two constants to the **Person** class of Chapter 10:

```
class Person {
 ...
 public static final int NAME = 0;
 public static final int AGE = 1;
 ...
}
```

Next we add a variable to the **Person** class to set which attribute to use in comparing two objects:

```
private static int compareAttribute = NAME;
```

Notice that the variable is a class variable because this information is not specific to any individual **Person** objects, but applies to the whole class. We initialize it to **NAME** so the

**Person** objects will be compared on the name attribute as a default. We define a class method to let the programmer set the comparison attribute. The class method is defined as

```
public static void setCompareAttribute(int attribute) {
 compareAttribute = attribute;
}
```

Although it is not a syntax error to initialize a class variable inside a constructor, it is a logical error to do so. You cannot define a constructor that includes an initialization of the **compareAttribute** variable, as in

```
public Person() {
 ...
 compareAttribute = NAME;
}
```

This definition is valid because the class variables can be accessed from the instance methods, but it is wrong to do so here. This constructor will set the class variable **compareAttribute** that is shared by all instances of the **Person** class every time a new **Person** object is created. This is not what we want. We need to initialize it exactly once when the class is loaded into the memory. One way to do this is to initialize at the point the class variable is declared as shown, or to use the **static block** we introduced in Chapter 7. Here's how:

static block

Use the **static** block to initialize class variables.

```
class Person {
 ...
 static {
 compareAttribute = NAME;
 }
 ...
}
```

The rule to remember is never to initialize the class variables in the constructor.

## Things to Remember



*Do not initialize class variables in the constructor. Initialize the class variables in the **static** block.*

Now we are ready to add a method **compareTo** that will compare the designated **Person** objects' names or ages and return the comparison result. The method is used like this:

```
//Persons p1 and p2 are defined and created already
//First set the comparison attribute to NAME
Person.setCompareAttribute(Person.NAME);
```

## 11.4 Sample Development—continued

```

int comparisonResult = p1.compareTo(p2);

if (comparisonResult < 0) {
 //p1's name is lexicographically less than p2's name
} else if (comparisonResult == 0) {
 //p1's name is equal to p2's name
} else { //comparisonResult > 0
 //p1's name is lexicographically larger than p2's name
}

```

To compare two **Person** objects on their ages, we write

```

//Persons p1 and p2 are defined and created already
//First set the comparison attribute to AGE
Person.setCompareAttribute(Person.AGE);

int comparisonResult = p1.compareTo(p2);

if (comparisonResult < 0) {
 //p1 is younger than p2
} else if (comparisonResult == 0) {
 //p1's age is the same as p2's age
} else { //comparisonResult > 0
 //p1 is older than p2
}

```

Here's the **compareTo** method:

```

public int compareTo(Person person) {
 int comparisonResult;

 if (compareAttribute == AGE) {
 int p2age = person.getAge();

 if (this.age < p2age) {
 comparisonResult = LESS;
 } else if (this.age == p2age) {
 comparisonResult = EQUAL;
 } else {
 assert this.age > p2age;
 comparisonResult = MORE;
 }
 }
}

```

```

 } else { //compare names with String's compareTo
 String p2name = person.getName();
 comparisonResult = this.name.compareTo(p2name);
 }
 return comparisonResult;
}

```

The constants **LESS**, **EQUAL**, and **MORE** are defined in the **Person** class as

```

private static int LESS = -1;
private static int EQUAL = 0;
private static int MORE = 1;

```

The **compareTo** method of the **String** class behaves just as our **compareTo** method does. Indeed, our **compareTo** method is modeled after the **String** class's **compareTo** method. The wrapper classes **Integer**, **Float**, **Double**, and others also define the analogous **compareTo** method. Having consistent naming and behavior for comparing two objects of the same class allows the implementation of a more general code. See Exercise 16 at the end of the chapter.

Here's the complete **Person** class:

```

/*
 Chapter 11 Sample Program: Person class
 File: Person.java
*/
class Person {
 public static final int NAME = 0;
 public static final int AGE = 1;

 private static final int LESS = -1;
 private static final int EQUAL = 0;
 private static final int MORE = 1;

 private static int compareAttribute;

 private String name;
 private int age;
 private char gender;

 // Static initializer
 static {
 compareAttribute = NAME;
 }

 public Person() {
 this("Not Given", 0, 'U');
 }
}

```

Data members

Constructors

## 11.4 Sample Development—continued

```

public Person(String name, int age, char gender) {
 this.age = age;
 this.name = name;
 this.gender = gender;
}

public static void setCompareAttribute(int attribute) {
 compareAttribute = attribute;
}

public int compareTo(Person person, int attribute) {
 int comparisonResult;

 if (attribute == AGE) {
 int p2age = person.getAge();

 if (this.age < p2age) {
 comparisonResult = LESS;
 } else if (this.age == p2age) {
 comparisonResult = EQUAL;
 } else {
 assert this.age > p2age;
 comparisonResult = MORE;
 }
 } else { //compare the name using the String class's
 //compareTo method
 String p2name = person.getName();
 comparisonResult = this.name.compareTo(p2name);
 }

 return comparisonResult;
}

public int compareTo(Person person) {
 return compareTo(person, compareAttribute);
}

public int getAge() {
 return age;
}

public char getGender() {
 return gender;
}

public String getName() {
 return name;
}

```

setCompareAttribute

compareTo

Accessors

```

public void setAge(int age) {
 this.age = age;
}

public void setGender(char gender) {
 this.gender = gender;
}

public void setName(String name) {
 this.name = name;
}

public String toString() {
 return this.name + "\t\t" +
 this.age + "\t\t" +
 this.gender;
}
}

```

Mutators

toString

Now we are ready to add a sorting routine to the **AddressBook** class. The **sort** method accepts one integer parameter that specifies the attribute to compare in sorting the **Person** objects. The method returns an array of **Person** objects sorted on the designated attribute. We use the bubble sort algorithm for the method. Using the heapsort algorithm is left as Exercise 17. Here's the **sort** method.

```

public Person[] sort(int attribute) {
 Person[] sortedList = new Person[count];
 Person p1, p2, temp;

 //copy references to sortedList; see Figure 11.17
 for (int i = 0; i < count; i++) {
 sortedList[i] = entry[i];
 }

 //Set the comparison attribute
 Person.setCompareAttribute(attribute);

 //begin the bubble sort on sortedList
 int bottom, comparisonResult;
 boolean exchanged = true;

 bottom = sortedList.length - 2;
 while (exchanged) {
 exchanged = false;
 for (int i = 0; i <= bottom; i++) {
 p1 = sortedList[i];

```



## 11.4 Sample Development—continued

```

 p2 = sortedList[i+1];

 comparisonResult = p1.compareTo(p2, attribute);

 if (comparisonResult > 0) { //p1 is 'larger'
 sortedList[i] = p2; //than p2,so
 sortedList[i+1] = p1; //exchange

 exchanged = true; //exchange is made
 }
 }
 bottom--;
}
return sortedList;
}

```

The **sort** method first creates a temporary array called **sortedList** and copies the references from the **entry** array into this **sortedList**. We do this so we can sort the objects on a specified attribute without affecting the order maintained in the **entry** array. Figure 11.17 illustrates how this **sortedList** array is used in sorting the **Person** objects on the **age** attribute.

Here's the **AddressBookVer1** class:

```

/*
 Chapter 11 Sample Program: Address Book Version 1
 File: AddressBookVer1.java
*/

class AddressBookVer1 implements AddressBook {

 private static final int DEFAULT_SIZE = 25;
 private static final int NOT_FOUND = -1;

 private Person[] entry;
 private int count;

 public AddressBookVer1(){
 this(DEFAULT_SIZE);
 }

 public AddressBookVer1(int size){
 count = 0;

 if (size <= 0) { //invalid data value, use default

```

Data members

Constructors

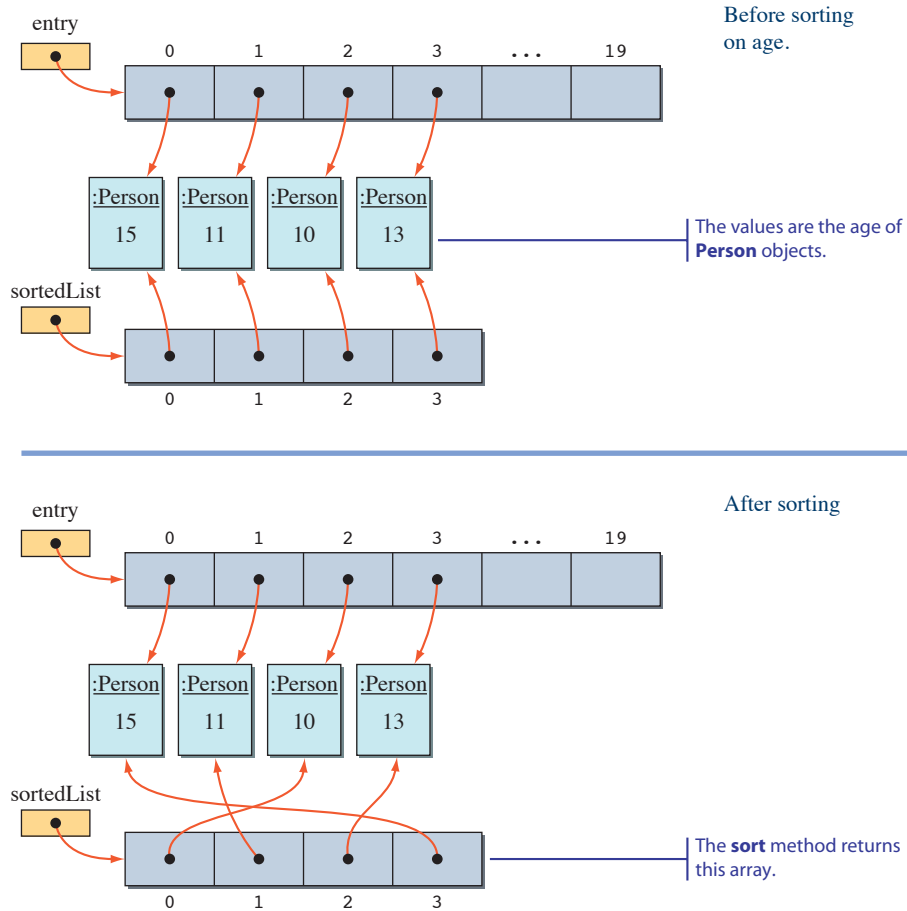

**Figure 11.17** The diagram illustrates how the separate array is used in sorting. Notice that the original array is unaffected by the sorting.

```

 throw new IllegalArgumentException("Size must be positive");
 }
 entry = new Person[size];
// System.out.println("array of " + size + " is created."); //TEMP
}
public void add(Person newPerson) {
 if (count == entry.length) { //no more space left,
 expand(); //create a new larger array
 }
}

```

add

## 11.4 Sample Development—continued

```

 //at this point, entry refers to a new larger array
 entry[count] = newPerson;
 count++;
 }

 public boolean delete(String searchName) {
 boolean status;
 int loc;

 loc = findIndex(searchName);

 if (loc == NOT_FOUND) {
 status = false;
 } else { //found, pack the hole

 entry[loc] = entry[count-1];

 status = true;
 count--; //decrement count,
 //since we now have one fewer element

 }

 return status;
 }

 public Person search(String searchName) {
 Person foundPerson;
 int loc = 0;

 while (loc < count &&
 !searchName.equals(entry[loc].getName())) {
 loc++;
 }

 if (loc == count) {
 foundPerson = null;
 } else {
 foundPerson = entry[loc];
 }

 return foundPerson;
 }

 public Person[] sort(int attribute) {
 Person[] sortedList = new Person[count];
 Person p1, p2, temp;

```

delete

search

sort

```

//copy references to sortedList
for (int i = 0; i < count; i++) {
 sortedList[i] = entry[i];
}

//set the comparison attribute
entry[0].setCompareAttribute(attribute);

//begin the bubble sort on sortedList
int bottom, comparisonResult;
boolean exchanged = true;

bottom = sortedList.length - 2;

while (exchanged) {
 exchanged = false;

 for (int i = 0; i <= bottom; i++) {
 p1 = sortedList[i];
 p2 = sortedList[i+1];
 // comparisonResult = p1.compareTo(p2, attribute);

 comparisonResult = p1.compareTo(p2);

 if (comparisonResult > 0) { //p1 is 'larger'
 //than p2, so
 sortedList[i] = p2; //exchange
 sortedList[i+1] = p1;

 exchanged = true; //exchange is made
 }
 }
 bottom--;
}
return sortedList;
}

private void expand() {
 //create a new array whose size is 150% of
 //the current array
 int newLength = (int) (1.5 * entry.length);
 Person[] temp = new Person[newLength];

 //now copy the data to the new array
 for (int i = 0; i < entry.length; i++) {
 temp[i] = entry[i];
 }

 //finally set the variable entry to point to the new array
 entry = temp;
}

```

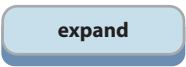

## 11.4 Sample Development—continued

```

// System.out.println("Inside the method enlarge"); //TEMP
// System.out.println("Size of a new array: " + entry.length); //TEMP
}

private int findIndex(String searchName) {
 int loc = 0;

 while (loc < count &&
 !searchName.equals(entry[loc].getName())) {
 loc++;
 }

 if (loc == count) {
 loc = NOT_FOUND;
 }

 return loc;
}
}

```



### Version 2

In the second implementation of the **AddressBook** interface, we will use the sorting routine provided in the **java.util.Arrays** class, which includes a number of useful methods for handling arrays. To use the **sort** method of the **Arrays** class, we must pass a comparator object as its second argument. A comparator object is an instance of a class that implements the **Comparator** interface. In the first version, we relied on the comparison routines embedded in the **Person** class. We are thus limited to what's provided by the **Person** class, namely, sorting by name or sorting by age. We cannot, for example, sort on gender and then within the same gender sort on age. By providing an implementation class of the **Comparator** interface, we can sort **Person** objects (or any other types of objects) in any manner we want.

To implement the **Comparator** interface, we must implement its **compare** method. The function of the **compare** method is similar to that of the **compareTo** method in the **Person** class. Any class that implements the **Comparator** interface must specify the type of the objects it will compare. For this example, the class compares **Person** objects, so the class will implement **Comparator<Person>**. The parameters for the **compare** method must match the specified type, which in this

case is **Person**. Here's the comparator class that compares two **Person** objects based on their age:

```
class AgeComparator implements Comparator <Person> {

 private final int LESS = -1;
 private final int EQUAL = 0;
 private final int MORE = 1;

 public int compare(Person p1, Person p2) {
 int comparisonResult;

 int p1age = p1.getAge();
 int p2age = p2.getAge();

 if (p1age < p2age) {
 comparisonResult = LESS;
 } else if (p1age == p2age) {
 comparisonResult = EQUAL;
 } else {
 assert p1age > p2age;
 comparisonResult = MORE;
 }

 return comparisonResult;
 }
}
```

The **NameComparator** is similarly defined. The **AgeComparator** and **NameComparator** classes are helper classes specific to the **AddressBookVer2** class, and as such, it is appropriate to define them as the inner classes of **AddressBookVer2**. An *inner class* is a class whose definition is given within the definition of another class, as in

inner class

```
class Outer {
 ...
 class Inner {
 ...
 } //end of Inner
} //end of Outer
```

We can prefix the inner class definition with the visibility modifier **public** or **private**. The **public** modifier will make the inner class accessible to the client classes outside of the package while the **private** modifier will make the inner class inaccessible to all other classes. Just as the ordinary class definition, a class definition without a visibility modifier is accessible to all other classes within the same package (classes in the same directory are in the same package).

## 11.4 Sample Development—continued

As for the actual sorting task, we will use the **sort** method of the **Arrays** class instead of writing our own sorting algorithm. The **sort** method of the **AddressBookVer2** class is now defined as follows:

```
public Person[] sort(int attribute) {
 if (!(attribute == Person.NAME ||
 attribute == Person.AGE)) {
 throw new IllegalArgumentException();
 }
 Person[] sortedList = new Person[count];
 //copy references to sortedList
 for (int i = 0; i < count; i++) {
 sortedList[i] = entry[i];
 }
 Arrays.sort(sortedList, getComparator(attribute));
 return sortedList;
}
```

Sorts the list by using the given comparator

And the private **getComparator** method is defined as follows:

```
private Comparator<String> getComparator(int attribute) {
 Comparator<String> comp = null;

 if (attribute == Person.AGE) {
 comp = new AgeComparator();
 } else {
 assert attribute == Person.NAME:
 "Attribute not recognized for sorting";
 comp = new NameComparator();
 }
 return comp;
}
```

The first argument to the **sort** method of the **Arrays** class is an array of objects we want to sort, and the second argument is the comparator to use in comparing array elements. For example, if we want to sort the **Person** objects by gender first and in descending order of age within the same gender, we can define the comparator as

```
class GenAgeComparator implements Comparator<Person> {
 private final int LESS = -1;
 private final int EQUAL = 0;
 private final int MORE = 1;
```

Notice that we are switching the positions of **p1** and **p2** because we are sorting in descending order.

```

public int compare(Person p1, Person p2) {
 int comparisonResult;

 int p1age = p1.getAge();
 int p2age = p2.getAge();

 char p1gender = p1.getGender();
 char p2gender = p2.getGender();

 if (p1gender < p2gender) {
 comparisonResult = LESS;
 } else if (p1gender == p2gender) {
 if (p2age < p1age) {
 comparisonResult = LESS;
 } else if (p2age == p1age) {
 comparisonResult = EQUAL;
 } else {
 assert p2age > p1age;
 comparisonResult = MORE;
 }
 } else {
 assert p1gender > p2gender;
 comparisonResult = MORE;
 }

 return comparisonResult;
}
}

```

and we can call the **sort** method as

```
Arrays.sort(sortedList, new GenAgeComparator());
```

Here's the **AddressBook2** class (only the modified portions are shown):

```

/*
 Chapter 11 Sample Program: Address Book Version 2
 File: AddressBookVer2.java
*/
import java.util.*;

class AddressBookVer2 implements AddressBook {

 public AddressBookVer2() {
 this(DEFAULT_SIZE);
 }
}

```



## 11.4 Sample Development—continued

```

public AddressBookVer2(int size) {
 ...
}
...
public Person[] sort(int attribute) {
 if (!(attribute == Person.NAME || attribute == Person.AGE)) {
 throw new IllegalArgumentException();
 }

 Person[] sortedList = new Person[count];

 //copy references to sortedList
 for (int i = 0; i < count; i++) {
 sortedList[i] = entry[i];
 }

 Arrays.sort(sortedList, getComparator(attribute));

 return sortedList;
}
...
private Comparator<String> getComparator(int attribute) {
 Comparator<String> comp = null;

 if (attribute == Person.AGE) {
 comp = new AgeComparator();
 } else {
 assert attribute == Person.NAME:
 "Attribute not recognized for sorting";

 comp = new NameComparator();
 }
 return comp;
}

// Inner Classes
//Inner class for comparing age
class AgeComparator implements Comparator<Person> {

 private final int LESS = -1;
 private final int EQUAL = 0;
 private final int MORE = 1;
}

```

```

public int compare(Person p1, Person p2) {
 int comparisonResult;

 int plage = p1.getAge();
 int p2age = p2.getAge();

 if (plage < p2age) {
 comparisonResult = LESS;
 } else if (plage == p2age) {
 comparisonResult = EQUAL;
 } else {
 assert plage > p2age;
 comparisonResult = MORE;
 }

 return comparisonResult;
}

//Inner class for comparing name
class NameComparator implements Comparator<String> {

 public int compare(Person p1, Person p2) {

 String plname = p1.getName();
 String p2name = p2.getName();

 return plname.compareTo(p2name);
 }
}
}

```

While the main purpose of the **AddressBookVer1** class is pedagogy, the **AddressBookVer2** class, with its use of the efficient **Arrays** class **sort** method based on a high-performance sorting technique called *merge sort* and the generality provided by the **Comparator** interface, is closer to what we would really use in practice. The last version, **AddressBookVer3**, would improve further by using the map from the Java Collection Framework. This eliminates the code to maintain the array in our class.

### Version 3

The third implementation of the **AddressBook** interface eliminates the use of an array altogether. Instead of maintaining the array of **Person** objects ourselves, we will rely on the service provided by the **Map** interface from the **java.util** package.

The key for the map is the person's name, and the value is the **Person** object. The **add**, **delete**, and **search** methods now all just make calls to the map's methods for data

## 11.4 Sample Development—continued

management. The **sort** method retrieves a collection of values in the map, converts this collection to an array, and then passes this array to the **sort** method of the **Arrays** class. Here's how we define the **sort** method:

```
public Person[] sort(int attribute) {
 if (!(attribute == Person.NAME ||
 attribute == Person.AGE)) {
 throw new IllegalArgumentException();
 }
 Person[] sortedList = new Person[entry.size()];
 entry.values().toArray(sortedList);
 Arrays.sort(sortedList, getComparator(attribute));
 return sortedList;
}
```

Here's the **AddressBookVer3** class:

```
/*
 Chapter 11 Sample Program: Address Book Version 3
 File: AddressBookVer3.java
*/
import java.util.*;

class AddressBookVer3 implements AddressBook {
 private static final int DEFAULT_SIZE = 25;
 private Map<String, Person> entry;

 public AddressBookVer3() {
 this(DEFAULT_SIZE);
 }

 public AddressBookVer3(int size) {
 entry = new HashMap<String, Person> (size);
 }

 public void add(Person newPerson) {
 entry.put(newPerson.getName(), newPerson);
 }

 public boolean delete(String searchName) {
 boolean status;
 Person p = entry.remove(searchName);
```

Data members

Constructors

add

delete

```

 if (p == null) {
 status = false;
 } else {
 status = true;
 }

 return status;
 }

 public Person search(String searchName) {
 return entry.get(searchName);
 }

 public Person[] sort(int attribute) {
 if (!(attribute == Person.NAME || attribute == Person.AGE)) {
 throw new IllegalArgumentException();
 }

 Person[] sortedList = new Person[entry.size()];
 entry.values().toArray(sortedList);

 Arrays.sort(sortedList, getComparator(attribute));

 return sortedList;
 }

 ...
}

```



## Summary

- Searching and sorting are two of the most basic nonnumeric applications of computer programs.
- Linear search looks for a value in a linear sequence.
- Binary search looks for a value by successively comparing the element in the middle of a sorted list.
- Selection sort is a basic sorting routine that runs in time proportion to  $N^2$ , where  $N$  is the size of the list to sort.
- Bubble sort is another  $N^2$  performance algorithm, but it runs faster than the selection sort on average.
- Heapsort has a  $N \log_2 N$  performance. It uses a special heap data structure to sort the elements.

- Using a class that implements the `Comparator` interface is convenient and flexible to dictate the manner in which objects of a class are compared.
- The `Comparator` interface has one method, called `compare`.
- The standard classes and interfaces described or used in this chapter are  

|                         |                     |
|-------------------------|---------------------|
| <code>Comparator</code> | <code>Arrays</code> |
|-------------------------|---------------------|

## Key Concepts

|                |                                |
|----------------|--------------------------------|
| linear search  | heapsort                       |
| binary search  | $N^2$ sorting algorithm        |
| selection sort | $N \log_2 N$ sorting algorithm |
| bubble sort    | comparator                     |

## Chapter 11 Exercises

### Review Exercises

1. Consider the following array of sorted integers:

|    |    |    |    |    |    |    |    |    |    |    |    |
|----|----|----|----|----|----|----|----|----|----|----|----|
| 0  | 1  | 2  | 3  | 4  | 5  | 6  | 7  | 8  | 9  | 10 | 11 |
| 10 | 15 | 25 | 30 | 33 | 34 | 46 | 55 | 78 | 84 | 96 | 99 |

- Using the binary search algorithm, search for 23. Show the sequence of array elements that are compared, and for each comparison, indicate the values for low and high.
2. We assumed all elements in an array are distinct; that is, there are no duplicate values in the array. What will be an effect on the linear search algorithm if an array contains duplicate values?
  3. Will the sorting algorithms presented in this chapter work if the unsorted array contains any duplicate values?
  4. In this chapter we analyzed sorting algorithms by counting the number of comparisons. Another possible method for analyzing the algorithms is to count the number of data exchanges. How many data exchanges do the selection and bubble sort make in the worst case? Regardless of the original list, the selection sort will make the same number of data exchanges. However, the number of data exchanges the bubble sort makes depends on the arrangement of elements in the original list.
  5. Analyze the insertion sort algorithm of Exercise 10 by counting the number of comparisons and data exchanges. Provide the analysis for the worst case.

### Level 1 Programming Exercises ★

6. Modify the selection sort algorithm to sort string data. Write a test program to verify the correct implementation.
7. Modify the bubble sort algorithm to sort string data. Write a test program to verify the correct implementation.
8. Write a program that input  $N$  words (string) and output them in alphabetical order. Use the sorting algorithm from Exercise 6 or Exercise 7.

### Level 2 Programming Exercises ★★

9. We started discussing sorting algorithms in Section 11.2 by presenting a basic sorting algorithm suitable for a human. We stated that the operation of crossing the numbers out for further consideration is effective for a human but not for a computer program. This is true when we are using an array. If we use a `LinkedList` (an `ArrayList` won't really work here because an array is used to implement an `ArrayList`) for the original (unsorted) list, then we can implement the action of crossing out a number and moving it to a sorted list effectively. Let `originalList` be a `LinkedList`. To remove an item of `originalList` at index position `I`, we write

```
originalList.remove(I);
```

This will actually remove the item from the list, not just marking it as removed, as is the case with an array. Write a program that implements this algorithm. Include a suitable input and output routines. You may restrict the data to integers only.

10. Another simple sorting algorithm is called an *insertion sort*. Suppose we have a sorted list of  $N$  elements and we need to insert a new element  $X$  into this list to create a sorted list of  $N + 1$  elements. We can insert  $X$  at the correct position in the list by comparing it with elements `list[N - 1]`, `list[N - 2]`, `list[N - 3]`, and so forth. Every time we compare  $X$  and `list[i]`, we shift `list[i]` one position to `list[i + 1]` if  $X$  is smaller than `list[i]`. When we find `list[i]` that is smaller than  $X$ , we put  $X$  at position  $i + 1$  and stop. We can apply this logic to sort an unordered list of  $N$  elements. We start with a sorted list of one element and insert the second element to create a sorted list of two elements. Then we add the third element to create a sorted list of three elements. Figure 11.18 illustrates the steps in the insertion sort. Write a program that implements the insertion sort algorithm. You may simplify the method by sorting only integers.
11. Write a test program to compare the performances of selection sort, bubble sort, and heapsort algorithms experimentally. Randomly generate 5000 integers, and sort the generated integers by using the three sorting algorithms. For each execution, record the time it took to sort the numbers.

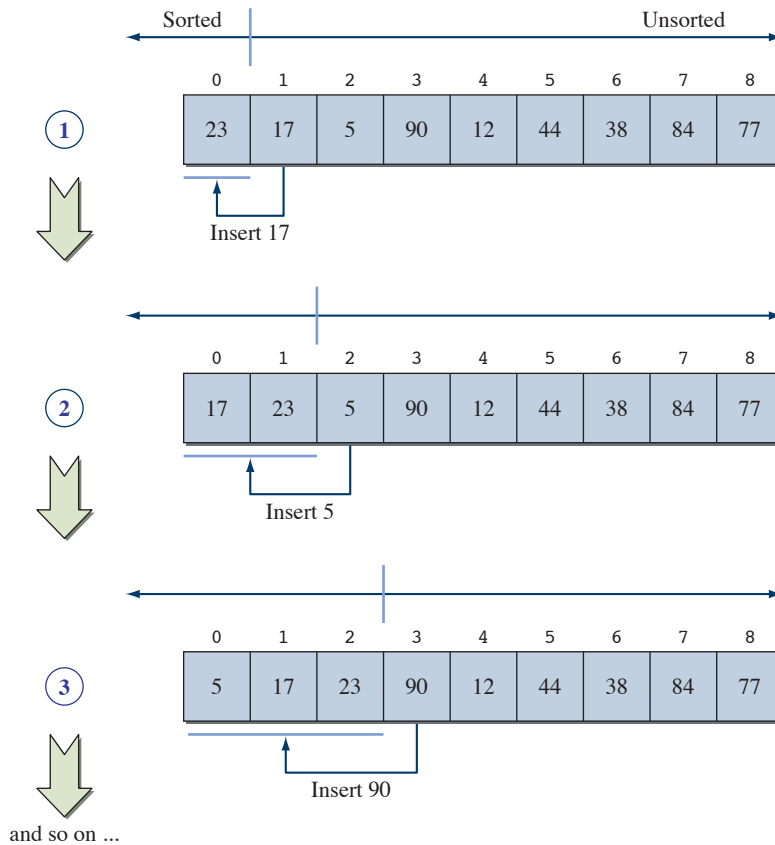

**Figure 11.18** Steps in an insertion sort.

You can use the `java.util.Date` class to record the execution time in milliseconds, for example,

```
Date startTime, endTime;
startTime = new Date();
//sort the integers
endTime = new Date();
//record the elapsed time
double elapsedTime
 = endTime.getTime() - startTime.getTime();
```

12. In the `Heap` class, we used two separate arrays: one for the heap and another for the sorted list. It turns out we can do everything with just one array. Notice that the heap will decrease in size by one element after every rebuild step. The unused space at the end of the heap array can be used to store the sorted list. Modify the `Heap` class so it will use only one array.

13. Modify the Heap class by defining a separate method called rebuild, which will be used by both the construct and extract methods.

### Level 3 Programming Exercises ★★★

14. Consider the following property about the bubble sort:

*If the last exchange made in some pass occurs at the  $J$ th and  $(J + 1)$ st positions, then all elements from the  $(J + 1)$ st to the  $N$ th positions are in their correct location.*

Improve the bubble sort algorithm by incorporating this property. Write a test program to verify the correct implementation of the modified bubble sort algorithm.

15. Consider another property about the bubble sort:

*If the first exchange made in some pass occurs at the  $I$ th and  $(I + 1)$ st positions, then all elements from the 1st to  $(I - 1)$ st positions are in ascending order.*

Improve the bubble sort algorithm by incorporating this property. Write a test program to verify the correct implementation of the modified bubble sort algorithm.

16. The Heap class given in Section 11.3 sorts only the integers. Improve the class by making it possible to sort any objects that recognize the compareTo method, which is described in Section 11.4, so the new Heap class will be able to sort Person, Integer, Double, and String objects among others. Since the elements in the internal array can be any object, declare an array of Object objects. All Java classes are automatically a subclass of Object, unless they are declared explicitly as a subclass of another class. The declaration of heap will be like this

```
private Object[] heap;
```

and the setData method will be like this:

```
public void setData(Object[] data) {
 heap = new Object[data.length];
 sortedList = new Object[data.length];
 for (int i = 0; i < data.length; i++) {
 heap[i] = data[i];
 }
}
```

17. In Section 11.4, we implemented the sorting routine for the AddressBook class with the bubble sort algorithm. Modify the sorting routine by using the Heap class of Exercise 16.
18. Instead of maintaining an unsorted list and returning the sorted list when the sort method is called, modify the AddressBook class so that it maintains the sorted list of Person in alphabetical order. Modify the search routine by using the binary search algorithm.





# File Input and Output

# 12

## O b j e c t i v e s

---

*After you have read and studied this chapter, you should be able to*

- Include a **JFileChooser** object in your program to let the user specify a file.
- Write bytes to a file and read them back from the file, using **FileOutputStream** and **FileInputStream**.
- Write values of primitive data types to a file and read them back from the file, using **DataOutputStream** and **DataInputStream**.
- Write text data to a file and read them back from the file, using **PrintWriter** and **BufferedReader**.
- Read a text file using **Scanner**.
- Write objects to a file and read them back from the file, using **ObjectOutputStream** and **ObjectInputStream**.

## Introduction



# W

hat is the most important action you should never forget to take while developing programs or writing documents? Saving the data, of course! It's 3 A.M., and you're in the home stretch, applying the finishing touches to the term paper due at 9 A.M. Just as you are ready to select the Print command for the final copy, it happens. The software freezes and it won't respond to your commands anymore. You forgot to turn on the Autosave feature, and you have not saved the data for the last hour. There's nothing you can do but reboot the computer.

Data not saved will be lost, and if we ever want to work on the data again, we must save the data to a file. We call the action of saving, or writing, data to a file *file output* and the action of reading data from a file *file input*. A program we develop must support some form of file input and output capabilities for it to have practical uses. Suppose we develop a program that keeps track of bicycles owned by the dorm students. The program will allow the user to add, delete, and modify the bicycle information. If the program does not support the file input and output features, every time the program is started, the user must reenter the data.

In this chapter, we will introduce the classes from the `java.io` and `javax.swing` packages that are used for file input and output operations. Also, we will show how the two helper classes from Chapters 8 and 9—`Dorm` and `FileManager`—that provided the file input and output support are implemented.

file output  
and input

## 12.1 | File and JFileChooser Objects

In this section we introduce two key objects for reading data from or writing data to a file. We use the term *file access* to refer to both read and write operations. If we need to be precise, we write *read access* or *write access*. (We use the terms *save* and *write* interchangeably to refer to file output, but we do not say *save access*.) Suppose we want to read the contents of a file `sample.data`. Before we can start reading data from this file, we must first create a **File** object (from the `java.io` package) and associate it to the file. We do so by calling a `File` constructor:

```
File inFile = new File("sample.data");
```

The argument to the constructor designates the name of the file to access. The system assumes the file is located in the *current directory*. For the following examples, we assume the directory structure shown in Figure 12.1, with `Ch12` being the current directory. When you run a program whose source file is located in directory `X`, then the current directory is `X`. Please refer to Java compiler manuals for other options for designating the current directory.

It is also possible to open a file that is stored in a directory other than the current directory by providing a path name and a filename. Assuming there's a file `xyz.data` in the `JavaPrograms` directory, we can open it by executing

```
File inFile = new File("C:\\JavaPrograms", "xyz.data");
```

File

current  
directory

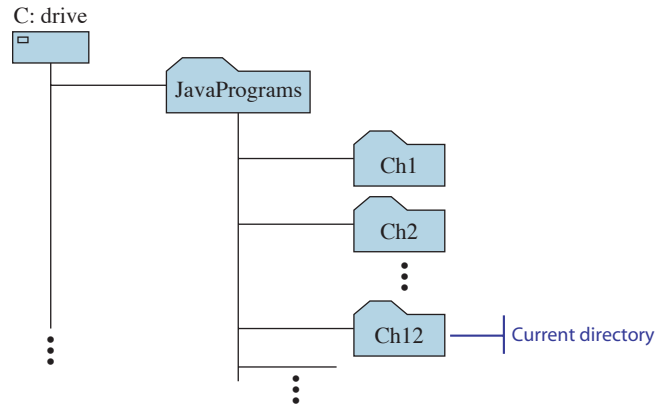

**Figure 12.1** Directory structure used for the examples in this section. We assume the Windows environment.

This style of designating the path name is for the Windows platform. The actual path name we want to specify is

```
C:\JavaPrograms
```

but the backslash character is an escape character. So to specify the backslash character itself, we must use double backslashes. For the UNIX platform, we use the forward slash for a delimiter, for example,

```
"/JavaPrograms"
```

For the Mac platform, we also use a forward slash; for example, if the name of a hard disk is MacHD, then we write

```
"/MacHD/JavaPrograms"
```

To maintain the consistency across the platforms, the forward slash character is allowed for the Windows platform also, such as in

```
"C:/JavaPrograms/Ch12"
```

The path name could be absolute or relative to the current directory. The absolute path name is the full path name beginning with the disk drive name, for example,

```
"C:/JavaPrograms/Ch12"
```

The relative path name is relative to the current directory. For example, if the current directory is Ch12, then the relative path name

```
"../Ch12"
```

is equivalent to the full path name

```
"C:/JavaPrograms/Ch12"
```

where the two dots (..) in the string mean “one directory above.”

We can check if a File object is associated correctly to an existing file by calling its exists method:

```
if (inFile.exists()) {
 // inFile is associated correctly to an existing file
} else {
 // inFile is not associated to any existing file
}
```

When a valid association is established, we say *the file is opened*; a file must be opened before we can do any input and output to the file.

## Things to Remember



*A file must be opened before we can execute any file access operations.*

A File object can also be associated to a directory. For example, suppose we are interested in listing the content of directory Ch12. We can first create a File object and associate it to the directory. After the association is made, we can list the contents of the directory by calling the object’s list method:

```
File directory = new File("C:/JavaPrograms/Ch12");
String filename[] = directory.list();

for (int i = 0; i < filename.length; i++) {
 System.out.println(filename[i]);
}
```

We check whether a File object is associated to a file or a directory by calling its boolean method isFile. The following code will print out I am a directory:

```
File file = new File("C:/JavaPrograms/Ch12");

if (file.isFile()) {
 System.out.println("I am a file");
} else {
 System.out.println("I am a directory");
}
```

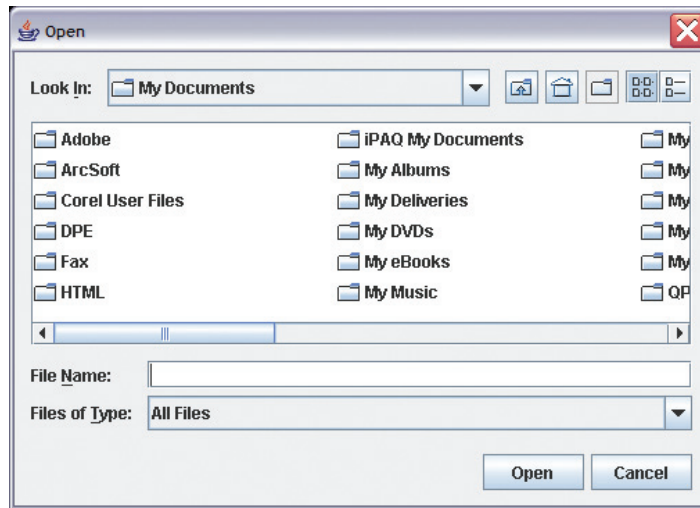

**Figure 12.2** A sample **JFileChooser** object displayed with the **showOpenDialog** method. The dialog title and the okay button are labeled **Open**.

### JFileChooser

We can use a `javax.swing.JFileChooser` object to let the user select a file. The following statement displays an open file dialog, such as the one shown in Figure 12.2 (the actual listing depends on the machine on which the program is executed):

```
JFileChooser chooser = new JFileChooser();
...
chooser.showOpenDialog(null);
```

The `null` argument to the `showOpenDialog` indicates that there's no parent frame window, and the dialog is displayed at the center of the screen. We pass a frame window object if we want to position the file dialog at the center of the frame. A frame window is discussed in Chapter 14. In this chapter, we use a `null` for the argument.

When we create an instance of `JFileChooser` by passing no arguments to the constructor, as in this example, it will list the content of the user's home directory. For the Windows platform, the user's home directory by default is the My Documents folder. We can set the file chooser to list the contents of a desired directory when it first appears on the screen. We can do this in two ways. The first is to pass the path name of the directory as a `String` argument to the constructor. For example, if we want to start the listing from the `C:/JavaPrograms/Ch12` directory, then we write

```
JFileChooser chooser
 = new JFileChooser("C:/JavaPrograms/Ch12");
...
chooser.showOpenDialog(null);
```

The second way is to use the `setCurrentDirectory` method as follows:

```
File startDir = new File("C:/JavaPrograms/Ch12");
chooser.setCurrentDirectory(startDir);
...
chooser.showOpenDialog(null);
```

Notice that we have to pass a `File` object, not a `String`, to the `setCurrentDirectory` method.

Instead of designating a fixed directory as in this example, we may wish to begin the listing from the current directory. Since the current directory is different when the program is executed from a different directory, we need a general approach. We can achieve the generality by writing

```
String current = System.getProperty("user.dir");
JFileChooser chooser
 = new JFileChooser(current);
...
```

or equivalently

```
String current = System.getProperty("user.dir");
JFileChooser chooser
 = new JFileChooser();
chooser.setCurrentDirectory(new File(current));
...
```

The content of `current` is the path name to the current directory.

To check whether the user has clicked on the `Open` or `Cancel` button, we test the return value from the `showOpenDialog` method.

```
int status = chooser.showOpenDialog(null);
if (status == JFileChooser.APPROVE_OPTION) {
 System.out.println("Open is clicked");
} else { //== JFileChooser.CANCEL_OPTION
 System.out.println("Cancel is clicked");
}
```

Once we determine the `Open` button is clicked, we can retrieve the selected file as

```
File selectedFile;
selectedFile = chooser.getSelectedFile();
```

and the current directory of the selected file as

```
File currentDirectory;
currentDirectory = chooser.getCurrentDirectory();
```

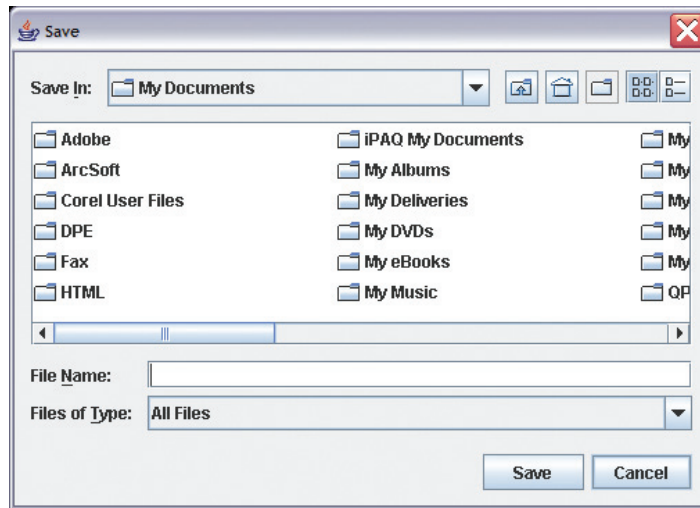

**Figure 12.3** A sample **JFileChooser** object displayed with the **showCloseDialog** method. The dialog title and the okay button are labeled **Save**.

To find out the name and the full path name of a selected file, we can use the `getName` and `getAbsolutePath` methods of the `File` class.

```
File file = chooser.getSelectedFile();

System.out.println("Selected File: " +
 file.getName());
System.out.println("Full path: " +
 file.getAbsolutePath());
```

To display a `JFileChooser` with the `Save` button, we write

```
chooser.showSaveDialog(null);
```

which results in a dialog shown in Figure 12.3 (the actual listing depends on the machine on which the program is executed).

The following `Ch12TestJFileChooser` class summarizes the methods of `JFileChooser` and `File` classes. Note this sample program does not perform actual file input or output.

```
/*
Chapter 12 Sample Program: Illustrate the use of the
 JFileChooser and File classes.

File: Ch12TestJFileChooser.java
*/
```



```

import java.io.*;
import javax.swing.*;

class Ch12TestJFileChooser {
 public static void main (String[] args) {

 JFileChooser chooser;
 File file, directory;
 int status;

 chooser = new JFileChooser();

 status = chooser.showOpenDialog(null);

 if (status == JFileChooser.APPROVE_OPTION) {
 file = chooser.getSelectedFile();
 directory = chooser.getCurrentDirectory();

 System.out.println("Directory: " +
 directory.getName());

 System.out.println("File selected to open: " +
 file.getName());

 System.out.println("Full path name: " +
 file.getAbsolutePath());

 } else {
 System.out.println("Open File dialog canceled");
 }

 System.out.println("\n\n");

 status = chooser.showSaveDialog(null);

 if (status == JFileChooser.APPROVE_OPTION) {
 file = chooser.getSelectedFile();
 directory = chooser.getCurrentDirectory();

 System.out.println("Directory: " +
 directory.getName());

 System.out.println("File selected for saving data: " +
 file.getName());

 System.out.println("Full path name: " +
 file.getAbsolutePath());

 } else {
 System.out.println("Save File dialog canceled");
 }

 }
}

```

```

C:\WINDOWS\System32\cmd.exe
Directory: My Documents
File selected to open: bookmark.htm
Full path name: C:\Documents and Settings\Otoyan\My Documents\bookmark.htm

Directory: My Documents
File selected for saving data: sampledb.htm
Full path name: C:\Documents and Settings\Otoyan\My Documents\sampledb.htm

```

**Figure 12.4** A sample output from running the `Ch12TestJFileChooser` program once.

Figure 12.4 shows a sample output of running the program once.

There is actually no distinction between the Open and Save dialogs created, respectively, by `showOpenDialog` and `showCloseDialog` other than the difference in the button label and the dialog title. In fact, they are really a shorthand for calling the `showDialog` method. Using the `showDialog` method, we can specify the button label and the dialog title. For example, this code will produce a `JFileChooser` dialog with the text `Compile` as its title and label for the okay button:

```

JFileChooser chooser = new JFileChooser();
chooser.showDialog(null, "Compile");

```

#### file filter

We can use a *file filter* to remove unwanted files from the list. Let's say we want to apply a filter so only the directories and the Java source files (those with the `.java` extension) are listed in the file chooser. To do so, we must define a subclass of the `javax.swing.filechooser.FileFilter` class and provide the `accept` and `getDescription` methods. The prototypes of these methods are

```

public boolean accept(File file)
public String getDescription()

```

The `accept` method returns `true` if the parameter file is a file to be included in the list. The `getDescription` method returns a text that will be displayed as one of the entries for the "Files of Type:" drop-down list. Here's how the filter subclass is defined:

```

/*
Chapter 12 Sample Program: Illustrate how to filter only
 Java source files
 for listing in JFileChooser
File: JavaFilter.java
*/
import java.io.File;
import javax.swing.filechooser.*;

```

Notice that we are stating one class in the package explicitly, instead of using the more common form of `import java.io.*;` to avoid naming conflict. The `java.io` package has the interface named `FileFilter`.

```

class JavaFilter extends FileFilter {

 private static final String JAVA = "java";
 private static final char DOT = '.';

 //accepts only directories and
 //files with .java extension only
 public boolean accept(File f) {

 if (f.isDirectory()) {
 return true;
 }

 if (extension(f).equalsIgnoreCase(JAVA)) {
 return true;
 } else {
 return false;
 }
 }

 //description of the filtered files
 public String getDescription() {
 return "Java source files (.java)";
 }

 //extracts the extension from the filename
 private String extension(File f) {

 String filename = f.getName();
 int loc = filename.lastIndexOf(DOT);

 if (loc > 0 && loc < filename.length() - 1) {
 //make sure the dot is not
 //at the first or the last character position
 return filename.substring(loc+1);
 } else {
 return "";
 }
 }
}

```

Data members

accept

getDescription

extension

With the filter class Java Filter in place, we can set a file chooser to list only directories and Java source files by writing

```

JFileChooser chooser = new JFileChooser();
chooser.setFileFilter(new JavaFilter());
int status = chooser.showOpenDialog(null);

```

## Quick CHECK



1. This question is specific to the Windows platform. Suppose you want to open a file `prog1.java` inside the directory `C:\JavaProjects\Ch11\Step4`. What is the actual String value you pass in the constructor for the `File` class?
2. What is wrong with the following statement?

```
JFileChooser chooser
 = new JFileChooser("Run");
chooser.showDialog(null);
```

3. Which method of the `JFileChooser` class do you use to get the filename of the selected file? What is returned from the method if the Cancel button is clicked?

## 12.2 | Low-Level File I/O

Once a file is opened by properly associating a `File` object to it, the actual file access can commence. In this section, we will introduce basic objects for file operations. To actually read data from or write data to a file, we must create one of the Java stream objects and attach it to the file. A *stream* is simply a sequence of data items, usually 8 bits per item. Java has two types of streams: an input stream and an output stream. An input stream has a *source* from which the data items come, and an output stream has a *destination* to which the data items go. To read data items from a file, we attach one of the Java input stream objects to the file. Similarly, to write data items to a file, we attach one of the Java output stream objects to the file.

Java comes with a large number of stream objects for file access operations. We will cover only those that are straightforward and easy to learn for beginners. We will study two of them in this section—`FileOutputStream` and `FileInputStream`. These two objects provide low-level file access operations. In Section 12.3 we will study other stream objects.

Let's first study how to write data values to a file by using `FileOutputStream`. Using a `FileOutputStream` object, we can output only a sequence of bytes, that is, values of data type `byte`. In this example, we will output an array of bytes to a file named `sample1.data`. First we create a `File` object:

```
File outFile = new File("sample1.data");
```

Then we associate a new `FileOutputStream` object to `outFile`:

```
FileOutputStream outputStream
 = new FileOutputStream(outFile);
```

Now we are ready for output. Consider the following byte array:

```
byte[] byteArray = {10, 20, 30, 40, 50, 60, 70, 80};
```

stream

source

destination

**FileOutput-  
Stream**

We write the whole byte array at once to the file by executing

```
outStream.write(byteArray);
```

Notice that we are not dealing with the File object directly, but with outStream. It is also possible to write array elements individually, for example,

```
//output the first and fifth bytes
outStream.write(byteArray[0]);
outStream.write(byteArray[4]);
```

After the values are written to the file, we must close the stream:

```
outStream.close();
```

If the stream object is not closed, then some data may get lost due to data caching. Because of the physical characteristics of secondary memory such as hard disks, the actual process of saving data to a file is a very time-consuming operation, whether you are saving 1 or 100 bytes. So instead of saving bytes individually, we save them in a block of, say, 500 bytes to reduce the overall time it takes to save the whole data. The operation of saving data as a block is called *data caching*. To carry out data caching, a part of memory is reserved as a *data buffer* or *cache*, which is used as a temporary holding place. A typical size for a data buffer is anywhere from 1 KB to 2 KB. Data are first written to a buffer, and when the buffer becomes full, the data in the buffer are actually written to a file. If there are any remaining data in the buffer and the file is not closed, then those data will be lost. Therefore, to avoid losing any data, it is important to close the file at the end of the operations.

data caching

data buffer

## Things to Remember



*To ensure that all data are saved to a file, close the file at the end of file access operations.*

Many of the file operations, such as write and close, throw I/O exceptions, so we need to handle them. For the short sample programs, we use the propagation approach. Here's the complete program:

```
/*
 Chapter 12 Sample Program:
 A test program to save data to a file using FileOutputStream
 File: Ch12TestFileOutputStream.java
*/
import java.io.*;

class Ch12TestFileOutputStream {
 public static void main (String[] args) throws IOException {
```

Needs this clause because the file methods throw I/O exceptions.

```

//set up file and stream
File outFile = new File("sample1.data");
FileOutputStream outStream = new FileOutputStream(outFile);

//data to output
byte[] byteArray = {10, 20, 30, 40, 50, 60, 70, 80};

//write data to the stream
outStream.write(byteArray);

//output done, so close the stream
outStream.close();
}
}

```

### Hints, & Tips, Pitfalls



It may seem odd at first to have both **File** and **FileStream** objects to input data from a file. Why not have just a **File** to handle everything? **File** represents a physical file that is a source of data. **Stream** objects represent the mechanism we associate to a file to perform input and output routines. **Stream** objects can also be associated to a nonfile data source such as a serial port. So separating the tasks following the STO principle resulted in more than one class to input data from a file.

Now it's true that we can make a shortcut statement such as

```

fileOutputStream outStream
 = new FileOutputStream("input.txt");

```

where we avoid the explicit creation of a **File** object. But this shortcut does not eliminate the fact that the **Stream** object is associated to a file.

### FileInput- Stream

To read the data into a program, we reverse the steps in the output routine. We use the read method of **FileInputStream** to read in an array of bytes. First we create a **FileInputStream** object:

```

File inFile = new File("sample1.data");
FileInputStream inStream = new FileInputStream(inFile);

```

Then we read the data into an array of bytes:

```

inStream.read(byteArray);

```

Before we call the read method, we must declare and create `byteArray`:

```

int filesize = (int) inFile.length();
byte[] byteArray = new byte[filesize];

```

We use the length method of the File class to determine the size of the file, which in this case is the number of bytes in the file. We create an array of bytes whose size is the size of the file.

The following program uses FileInputStream to read in the byte array from the file sample1.data.

```

/*
 Chapter 12 Sample Program:
 A test program to read data from a file using
 FileInputStream

 File: Ch12TestFileInputStream.java
*/
import java.io.*;

class Ch12TestFileInputStream {
 public static void main (String[] args) throws IOException {

 //set up file and stream
 File inFile = new File("sample1.data");
 FileInputStream inStream = new FileInputStream(inFile);

 //set up an array to read data in
 int fileSize = (int) inFile.length();
 byte[] byteArray = new byte[fileSize];

 //read data in and display them
 inStream.read(byteArray);
 for (int i = 0; i < fileSize; i++) {
 System.out.println(byteArray[i]);
 }

 //input done, so close the stream
 inStream.close();
 }
}

```

It is possible to output data other than bytes if we can convert (i.e., typecast) them into bytes. For example, we can output character data by typecasting them to bytes.

```

File outFile = new File("sample1.data");
FileOutputStream outStream = new FileOutputStream(outFile);

//data to output
byte[] byteArray = {(byte) 'J',
 (byte) 'a',
 (byte) 'v',
 (byte) 'a' };

```

Typecast characters to bytes.

```
//write data to the stream
outStream.write(byteArray);

//output done, so close the stream
outStream.close();
```

To read the data back, we use the read method again. If we need to display the bytes in the original character values, we need to typecast byte to char. Without the typecasting, numerical values would be displayed. The following code illustrates the typecasting of byte to char for display.

```
File inFile = new File("sample1.data");
FileInputStream inStream = new FileInputStream(inFile);

//set up an array to read data in
int fileSize = inFile.length();
byte[] byteArray = new byte[fileSize];

//read data in and display them
inStream.read(byteArray);

for (int i = 0; i < fileSize; i++) {
 System.out.println((char) byteArray[i]);
}

//input done, so close the stream
inStream.close();
```

Typecast bytes back to characters.

Typecasting char to byte or byte to char is simple because ASCII uses 8 bits. But what if we want to perform file I/O on numerical values such as integers and real numbers? It takes more than simple typecasting to output these numerical values to `FileOutputStream` and read them back from `FileInputStream`. An integer takes 4 bytes, so we need to break a single integer into 4 bytes and perform file I/O on this 4 bytes. Such a conversion would be too low-level and tedious. Java provides stream objects that allow us to read from or write numerical values to a file without doing any conversions ourselves. We will discuss two of them in Section 12.3.

## Quick CHECK

1. What is the method you call at the end of all file I/O operations?
2. What is wrong with the following statements? Assume that `outStream` is a properly declared and created `FileOutputStream` object.

```
byte[] byteArray = {(byte) 'H', (byte) 'i'};
...
outStream.print(byteArray);
...
outStream.close();
```



## 12.3 High-Level File I/O

By using `DataOutputStream`, we can output Java primitive data type values. A `DataOutputStream` object will take care of the details of converting the primitive data type values to a sequence of bytes. Let's look at the complete program first. The following program writes out values of various Java primitive data types to a file. The names of the output methods (those preceded with `write`) should be self-explanatory.

```

/*
Chapter 12 Sample Program:
 A test program to save data to a file using
 DataOutputStream for high-level I/O.

File: Ch12TestDataOutputStream.java
*/
import java.io.*;

class Ch12TestDataOutputStream {
 public static void main (String[] args) throws IOException {

 //set up the streams
 File outFile = new File("sample2.data");
 FileOutputStream outFileStream = new FileOutputStream(outFile);
 DataOutputStream outDataStream = new DataOutputStream
 (outFileStream);

 //write values of primitive data types to the stream
 outDataStream.writeInt(987654321);
 outDataStream.writeLong(11111111L);
 outDataStream.writeFloat(22222222F);
 outDataStream.writeDouble(33333333D);
 outDataStream.writeChar('A');
 outDataStream.writeBoolean(true);

 //output done, so close the stream
 outDataStream.close();
 }
}

```

Notice the sequence of statements for creating a `DataOutputStream` object:

```

File outFile = new File("sample2.data");
FileOutputStream outFileStream= new FileOutputStream(outFile);
DataOutputStream outDataStream
 = new DataOutputStream(outFileStream);

```

```
File outFile = new File("sample2.data");
FileOutputStream outFileStream = new FileOutputStream(outFile);
DataOutputStream outDataStream = new DataOutputStream(outFileStream);
```

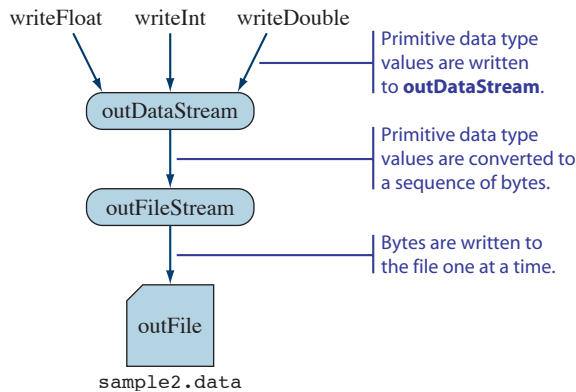

**Figure 12.5** A diagram showing how the three objects **outFile**, **outFileStream**, and **outDataStream** are related.

#### DataOutput-Stream

The argument to the **DataOutputStream** constructor is a **FileOutputStream** object. A **DataOutputStream** object does not get connected to a file directly. The diagram in Figure 12.5 illustrates the relationships established among the three objects. The role of the **DataOutputStream** object is to provide high-level access to a file by converting a primitive data value to a sequence of bytes, which are then written to a file via a **FileOutputStream** object.

#### DataInput-Stream

To read the data back from the file, we reverse the operation. We use three objects: **File**, **FileInputStream**, and **DataInputStream**. The following program reads the data saved by the program **Ch12TestDataOutputStream**.

```
/*
Chapter 12 Sample Program:
A test program to load data from a file using
DataInputStream for high-level I/O.

File: Ch12TestDataInputStream.java
*/
import java.io.*;

class Ch12TestDataInputStream {
 public static void main (String[] args) throws IOException {

 //set up file and stream
 File inFile = new File("sample2.data");
 FileInputStream inFileStream = new FileInputStream(inFile);
 DataInputStream inDataStream = new DataInputStream(inFileStream);
```

```

//read values back from the stream and display them
System.out.println(inDataStream.readInt());
System.out.println(inDataStream.readLong());
System.out.println(inDataStream.readFloat());
System.out.println(inDataStream.readDouble());
System.out.println(inDataStream.readChar());
System.out.println(inDataStream.readBoolean());

//input done, so close the stream
inDataStream.close();
}
}

```

Figure 12.6 shows the relationship among the three objects. Notice that we must read the data back in the precise order. In other words, if we write data in the order of integer, float, and character, then we must read the data back in that order, as illustrated in Figure 12.7. If we don't read the data back in the correct order, the results will be unpredictable.

binary file

Both `FileOutputStream` and `DataOutputStream` objects produce a *binary file* in which the contents are stored in the format (called *binary format*) in which they are stored in the main memory. Instead of storing data in binary format, we can store them in ASCII format. With the ASCII format, all data are converted to string data. A file whose contents are stored in ASCII format is called a *text file*. One major

text file

```

File inFile = new File("sample2.data");
FileInputStream inFileStream = new FileInputStream(inFile);
DataInputStream inDataStream = new DataInputStream(inFileStream);

```

Primitive data type values are read from `inDataStream`.

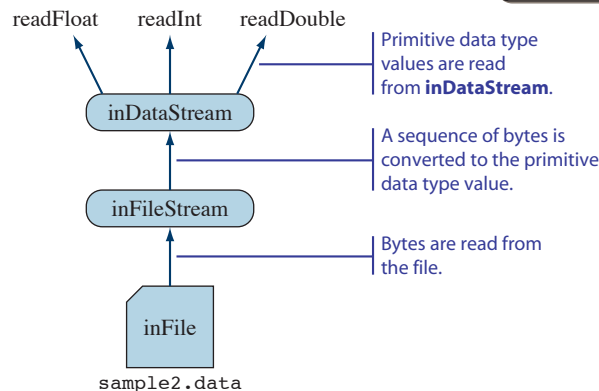

**Figure 12.6** A diagram showing how the three objects `inFile`, `inFileStream`, and `inDataStream` are related.

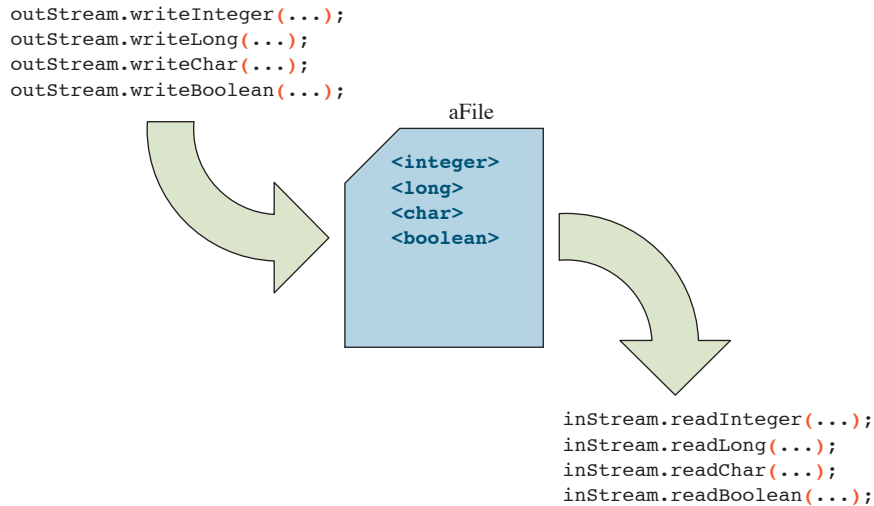

**Figure 12.7** The order of write and read operations must match to read the stored data back correctly.

benefit of a text file is that we can easily read and modify the contents of a text file by using any text editor or word processor.

`PrintWriter` is an object we use to generate a text file. Unlike `DataOutputStream`, where we have a separate write method for each individual data type, `PrintWriter` supports only two output methods: `print` and `println` (for print line). An argument to the methods can be any primitive data type. The methods convert the parameter to string and output this string value. The constructor of `PrintWriter`, similar to the one for `DataOutputStream`, requires an output stream as its argument. In the following program, the parameter is again an instance of `FileOutputStream`.

```

/*
Chapter 12 Sample Program:
 A test program to save data to a file using
 PrintWriter for high-level I/O.

File: Ch12TestPrintWriter.java
*/
import java.io.*;

class Ch12TestPrintWriter {
 public static void main (String[] args) throws IOException {

 //set up file and stream
 File outFile = new File("sample3.data");
 FileOutputStream outFileStream = new FileOutputStream(outFile);
 PrintWriter outputStream = new PrintWriter(outFileStream);
 }
}

```

```

//write values of primitive data types to the stream
outStream.println(987654321);
outStream.println(11111111L);
outStream.println(22222222F);
outStream.println(33333333D);
outStream.println('A');
outStream.println(true);

//output done, so close the stream
outStream.close();
}
}

```

We use **print** and **println** with **PrintWriter**. The **print** and **println** methods convert primitive data types to strings before writing to a file.

To read the data from a text file, we use the `FileReader` and `BufferedReader` objects. The relationship between `FileReader` and `BufferedReader` is similar to the one between `FileInputStream` and `DataInputStream`. To read data back from a text file, first we need to associate a `BufferedReader` object to a file. The following sequence of statements associates a `BufferedReader` object to a file `sample3.data`:

```

File inFile = new File("sample3.data");
FileReader fileReader = new FileReader(inFile);
BufferedReader bufReader
 = new BufferedReader(fileReader);

```

Then we read data, using the `readLine` method of `BufferedReader`,

```
String str = bufReader.readLine();
```

and convert the `String` to a primitive data type as necessary.

Here's the program to read back from `sample3.data`, which was created by the program `Ch12TestPrintWriter`:

```

/*
Chapter 12 Sample Program:
A test program to load data from a file using the readLine
method of BufferedReader for high-level String input.

File: Ch12TestBufferedReader.java
*/
import java.io.*;

class Ch12TestBufferedReader {
 public static void main (String[] args) throws IOException {

 //set up file and stream
 File inFile = new File("sample3.data");

```

```

FileReader fileReader = new FileReader(inFile);
BufferedReader bufReader = new BufferedReader(fileReader);
String str;

//get integer
str = bufReader.readLine();
int i = Integer.parseInt(str);

//get long
str = bufReader.readLine();
long l = Long.parseLong(str);

//get float
str = bufReader.readLine();
float f = Float.parseFloat(str);

//get double
str = bufReader.readLine();
double d = Double.parseDouble(str);

//get char
str = bufReader.readLine();
char c = str.charAt(0);

//get boolean
str = bufReader.readLine();
Boolean boolObj = new Boolean(str);
boolean b = boolObj.booleanValue();

System.out.println(i);
System.out.println(l);
System.out.println(f);
System.out.println(d);
System.out.println(c);
System.out.println(b);

//input done, so close the stream
bufReader.close();
}
}

```

Data are saved in ASCII format, so the conversion to the primitive data format is required.

**Note:** Here we only output, so there's no real need to perform data conversion. But in general we need to convert ASCII data to primitive data types to process them in the program.

Since Java 5.0, we can use the Scanner class introduced in Chapter 3 to input data from a text file. Instead of associating a new Scanner object to System.in, we can associate it to a File object. For example,

```

Scanner scanner = new Scanner(
 new File("sample3.data"));

```

will associate scanner to the file `sample3.data`. Once this association is made, we can use scanner methods such as `nextInt`, `next`, and others to input data from the file.

The following sample code does the same as `Ch12TestBufferedReader` but uses the `Scanner` class instead of `BufferedReader`. Notice that the conversion is not necessary with the `Scanner` class by using appropriate input methods such as `nextInt` and `nextDouble`.

```

/*
 Chapter 12 Sample Program:
 Illustrate the use of Scanner to input text file

 File: Ch12TestScanner.java
*/

import java.util.*;
import java.io.*;

class Ch12TestScanner {

 public static void main (String args[]) throws FileNotFoundException,
 IOException {

 //open the Scanner

 Scanner scanner = new Scanner(new File("sample3.data"));

 //get integer
 int i = scanner.nextInt();

 //get integer
 long l = scanner.nextLong();

 //get float
 float f = scanner.nextFloat();

 //get double
 double d = scanner.nextDouble();

 //get char
 char c = scanner.next().charAt(0);

 //get boolean
 boolean b = scanner.nextBoolean();

 System.out.println(i);
 System.out.println(l);
 System.out.println(f);
 System.out.println(d);
 }
}

```

```

System.out.println(c);
System.out.println(b);

//input done, so close the scanner
scanner.close();
}
}

```

### The FileManager Class

In the Chapter 9 sample development and in Section 12.1, we used the helper class `FileManager`. A `FileManager` object provides file I/O operations for `String` data. To refresh our memory, here are the public methods of the class:

| Public Methods of <code>FileManager</code>                                                                                                                                                                 |
|------------------------------------------------------------------------------------------------------------------------------------------------------------------------------------------------------------|
| <pre> <b>public</b> String openFile(String filename)                         <b>throws</b> FileNotFoundException, IOException     Opens the text file filename and returns the content as a String. </pre> |
| <pre> <b>public</b> String openFile( ) <b>throws</b> IOException     Opens the text file selected by the end user using the standard file open dialog     and returns the content as a String. </pre>      |
| <pre> <b>public</b> String saveFile(String filename, String data)                         <b>throws</b> IOException     Saves the string data to filename. </pre>                                          |
| <pre> <b>public</b> String saveFile(String data) <b>throws</b> IOException     Saves the string data to a file selected by the end user using the standard file     save dialog. </pre>                    |

The class uses the `PrintWriter` and `BufferedReader` classes for text (`String`) output and input. Notice that all public methods throw an `IOException`, and only the `openFile` method that accepts a filename as an argument throws `FileNotFoundException` also. Here is the class listing:

```

/*
 Chapter 9 and Chapter 12 Helper Class
 File: FileManager.java
*/
import java.io.*;
import javax.swing.*;
class FileManager {

```



```

private static final String EMPTY_STRING = "";
private static String lineTerminator
 = System.getProperty("line.separator");

public FileManager() {
}

public String openFile() throws FileNotFoundException,
 IOException {
 String filename, doc = EMPTY_STRING;

 JFileChooser chooser = new JFileChooser(
 System.getProperty("user.dir"));
 int reply = chooser.showOpenDialog(null);

 if(reply == JFileChooser.APPROVE_OPTION) {
 doc = openFile(chooser.getSelectedFile().getAbsolutePath());
 }

 return doc;
}

public String openFile(String filename)
 throws FileNotFoundException, IOException {

 String line;
 StringBuffer document = new StringBuffer(EMPTY_STRING);

 File inFile = new File(filename);
 FileReader fileReader = new FileReader(inFile);
 BufferedReader bufReader = new BufferedReader(fileReader);

 while (true) {
 line = bufReader.readLine();

 if (line == null) break;

 document.append(line + lineTerminator);
 }

 return document.toString();
}

public void saveFile(String data) throws IOException {
 String filename, doc = EMPTY_STRING;

 JFileChooser chooser = new JFileChooser(
 System.getProperty("user.dir"));
 int reply = chooser.showSaveDialog(null);

 if(reply == JFileChooser.APPROVE_OPTION) {
 saveFile(chooser.getSelectedFile().getAbsolutePath(),
 data);
 }
}

```

openFile

saveFile

```

public void saveFile(String filename, String data)
 throws IOException {

 File outFile = new File(filename);
 FileOutputStream outFileStream = new FileOutputStream(outFile);
 PrintWriter outputStream = new PrintWriter(outFileStream);

 outputStream.print(data);

 outputStream.close();

}
}

```



1. Which type of files can be opened and viewed by a text editor?
2. Which class is used to save data as a text file? Which class is used to read text files?
3. Assume `bufReader`, a `BufferedReader` object, is properly declared and created. What is wrong with the following?

```
double d = bufReader.readDouble();
```

## 12.4 | Object I/O

With Java, we can store objects just as easily as we can store primitive data values. There are object-oriented programming languages that won't allow programmers to store objects directly. In those programming languages, we must write code to store individual data members of an object separately. For example, if a `Person` object has data members `name` (`String`), `age` (`int`), and `gender` (`char`), then we have to store the three values individually, using the file I/O techniques explained earlier in the chapter. (*Note:* `String` is an object, but it can be treated much as any other primitive data types because of its immutability.) Now, if the data members of an object are all primitive data types (or a `String`), then storing the data members individually is a chore but not that difficult. However, if a data member is a reference to another object or to an array of objects, then storing data can become very tricky. Fortunately with Java, we don't have to worry about them; we can store objects directly to a file.

In this section, we will describe various approaches for storing objects. To write objects to a file, we use **ObjectOutputStream**; and to read objects from a file, we use **ObjectInputStream**. Let's see how we write `Person` objects to a file. First we need to modify the definition of the `Person` class in order for `ObjectOutputStream` and

**ObjectOut-  
putStream**

**ObjectInput-  
Stream**

ObjectInputStream to perform object I/O. We modify the definition by adding the phrase `implements Serializable` to it.

```
import java.io.*;
class Person implements Serializable {
 //the rest is the same
}
```

**Serializable** is defined in `java.io`.

Whenever we want to store an object to a file, we modify its class definition by adding the phrase `implements Serializable` to it. Unlike other interfaces, such as `ActionListener`, there are no methods for us to define in the implementation class. All we have to do is to add the phrase.

### Things to Remember



*If we want to perform an object I/O, then the class definition must include the phrase `implements Serializable`.*

To save objects to a file, we first create an `ObjectOutputStream` object:

```
File outFile
 = new File("objects.dat");
FileOutputStream outFileStream
 = new FileOutputStream(outFile);
ObjectOutputStream outObjectStream
 = new ObjectOutputStream
 (outFileStream);
```

To save a `Person` object, we write

```
Person person = new Person("Mr. Espresso", 20, 'M');
outObjectStream.writeObject(person);
```

The following sample program saves 10 `Person` objects to a file:

```
/*
 Chapter 12 Sample Program: Illustrate the use of ObjectOutputStream
 File: Ch12TestObjectOutputStream.java
*/
import java.io.*;
```

```

class Ch12TestObjectOutputStream {
 public static void main (String[] args) throws IOException {

 //set up the streams
 File outFile = new File("objects.dat");
 FileOutputStream outFileStream
 = new FileOutputStream(outFile);
 ObjectOutputStream outObjectStream
 = new ObjectOutputStream(outFileStream);

 //write serializable Person objects one at a time
 Person person;
 for (int i = 0; i < 10; i++) {
 person = new Person("Mr. Espresso" + i, 20+i, 'M');

 outObjectStream.writeObject(person);
 }

 //output done, so close the stream
 outObjectStream.close();
 }
}

```

It is possible to save different types of objects to a single file. Assuming the Account and Bank classes are defined properly, we can save both types of objects to a single file:

```

Account account1, account2;
Bank bank1, bank2;

account1 = new Account(); //create objects
account2 = new Account();
bank1 = new Bank();
bank2 = new Bank();

outObjectStream.writeObject(account1);
outObjectStream.writeObject(account2);
outObjectStream.writeObject(bank1);
outObjectStream.writeObject(bank2);

```

We can even mix objects and primitive data type values, for example,

```

outObjectStream.writeInt (15);
outObjectStream.writeObject(account1);
outObjectStream.writeChar ('X');

```

To read objects from a file, we use `FileInputStream` and `ObjectInputStream`. We use the method `readObject` to read an object. Since we can store any types of

objects to a single file, we need to typecast the object read from the file. Here's an example of reading a `Person` object we saved in the file `objects.data`.

```
File inFile
 = new File("objects.dat");

FileInputStream inFileStream
 = new FileInputStream(inFile);

ObjectInputStream inObjectStream
 = new ObjectInputStream(inFileStream);

Person person = (Person) inObjectStream.readObject();
```

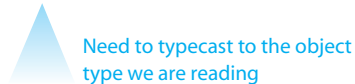

#### ClassNot-Found-Exception

Because there is a possibility of wrong typecasting, the `readObject` method can throw a **ClassNotFoundException** in addition to an `IOException`. You can catch or propagate either or both exceptions. If you propagate both exceptions, then the declaration of a method that contains the call to `readObject` will look like this:

```
public void myMethod()
 throws IOException, ClassNotFoundException {
 ...
}
```

The following sample program reads the `Person` objects from the `objects.dat` file:

```
/*
Chapter 12 Sample Program: Illustrate the use of ObjectInputStream
File: Ch12TestObjectInputStream.java
*/
import java.io.*;

class Ch12TestObjectInputStream {
 public static void main (String[] args) throws ClassNotFoundException,
 IOException {

 //set up file and stream
 File inFile = new File("objects.dat");

 FileInputStream inFileStream
 = new FileInputStream(inFile);

 ObjectInputStream inObjectStream
 = new ObjectInputStream(inFileStream);
```

```

//read the Person objects from a file
Person person;
for (int i = 0; i < 10; i++) {
 person = (Person) inObjectStream.readObject();

 System.out.println(person.getName() + " " +
 person.getAge() + " " +
 person.getGender());
}

//input done, so close the stream
inObjectStream.close();
}
}

```

If a file contains objects from different classes, we must read them in the correct order and apply the matching typecasting. For example, if the file contains two Account and two Bank objects, then we must read them in the correct order:

```

account1 = (Account) inObjectStream.readObject();
account2 = (Account) inObjectStream.readObject();
bank1 = (Bank) inObjectStream.readObject();
bank2 = (Bank) inObjectStream.readObject();

```

Now, consider the following array of Person objects where N represents some integer value:

```
Person[] people = new Person[N];
```

Assuming that all N Person objects are in the array, we can store them to file as

```

//save the size of an array first
outObjectStream.writeInt(people.length);

//save Person objects next
for (int i = 0; i < people.length; i++) {
 outObjectStream.writeObject(people[i]);
}

```

We store the size of an array at the beginning of the file, so we know exactly how many Person objects to read back:

```

int N = inObjectStream.readInt();
for (int i = 0; i < N; i++) {
 people[i] = (Person) inObjectStream.readObject();
}

```

We can actually store the whole array with a single writeObject method, instead of storing individual elements one at a time, that is, calling the writeObject

method for each element. The whole people array can be stored with a single statement as

```
outObjectStream.writeObject(people);
```

and the whole array is read back with a single statement as

```
people = (Person[]) inObjectStream.readObject();
```

Notice how the typecasting is done. We are reading an array of Person objects, so the typecasting is (Person[]). This approach will work with any data structure object such as a list or map.

### The Dorm class

In the Chapter 8 sample development, we used the helper class Dorm to manage a list of Resident objects. A Dorm object is capable of saving a Resident list to a file and reading the list from a file. The class uses object I/O discussed in this section to perform these tasks. A list of Resident objects is maintained by using a HashMap. Instead of saving Resident objects individually, the whole map is saved with a single writeObject method and is read by a single readObject method. (The map data structure was explained in Chapter 10.) Here's the complete listing:

```

/*
Chapter 8 Sample Development Helper Class

File: Dorm.java
*/

import java.io.*;
import java.util.*;

public class Dorm {

 private Map<String,Resident> residentTable;

 public Dorm() {
 residentTable = new HashMap<String,Resident>();
 }

 public Dorm(String filename)
 throws FileNotFoundException,
 IOException {

 openFile(filename);
 }

 public void add(Resident resident)
 throws IllegalArgumentException{

 if (residentTable.containsKey(resident.getName())) {
 throw new IllegalArgumentException(
 "Resident with the same name already exists");
 }
 }
}

```

Constructors

add

```

 } else {
 residentTable.put(resident.getName(), resident);
 }
}

public void delete(String name) {
 residentTable.remove(name);
}

public Resident getResident(String name) {
 return residentTable.get(name);
}

public String getResidentList() {
 StringBuffer result = new StringBuffer("");

 String tab = "\t";
 String lineSeparator = System.getProperty("line.separator");

 for (Resident res: residentTable.values()) {
 result.append(res.getName() + tab +
 res.getRoom() + tab +
 res.getPassword() + tab +
 lineSeparator);
 }

 return result.toString();
}

public void openFile(String filename)
 throws FileNotFoundException,
 IOException {
 File inFile = new File(filename);
 FileInputStream inFileStream =
 new FileInputStream(inFile);
 ObjectInputStream inObjectStream =
 new ObjectInputStream(inFileStream);

 try {
 residentTable = (Map<String,Resident>)
 inObjectStream.readObject();
 } catch (ClassNotFoundException e) {
 throw new IOException(
 "Unrecognized data in the designated file");
 }

 inObjectStream.close();
}

public void saveFile(String filename)
 throws IOException {

```

delete

getResident

getResidentList

openFile

saveFile



```

File outFile = new File(filename);
FileOutputStream outFileStream =
 new FileOutputStream(outFile);
ObjectOutputStream outObjectStream =
 new ObjectOutputStream(outFileStream);

outObjectStream.writeObject(residentTable);

outObjectStream.close();
 }
}

```



1. When do you have to include the clause `implements Serializable` to a class definition?
2. You cannot save the whole array at once—you must save the array elements individually, true or false?

## 12.5 Sample Development

### Saving an AddressBook Object

As an illustration of object I/O, we will write a class that handles the storage of an **AddressBook** object. The class will provide methods to write an **AddressBook** object to a file and to read the object back from the file.

#### Problem Statement

*Write a class that manages file I/O of an **AddressBook** object.*

#### Overall Plan

Before we begin to design the class, we must modify the definition of the class that implements the **AddressBook** interface by adding the phrase **implements Serializable**, such as

```

import java.io.*;
class AddressBookVer1 implements AddressBook,
 Serializable {
 //same as before
}

```

In the following discussion, we will use the implementation class **AddressBookVers1**. This modification allows us to store instances of the **AddressBookVer1** class. We will use

the expression “an **AddressBook** object” to refer to an instance of any class that implements the **AddressBook** interface.

Since the class handles the file I/O operations, we will call the class **AddressBookStorage**. Following the STO (single-task object) principle, this class will be responsible solely for file I/O of an **AddressBook** object. The class will not perform, for instance, any operations that deal with a user interface.

What kinds of core operations should this class support? Since the class handles the file I/O, the class should support two public methods to write and read an **AddressBook** object. Let’s call the methods **write** and **read**. The argument will be an **AddressBook** object we want to write or read. If **filer** is an **AddressBookStorage** object, then the calls should be something like

```
filer.write(addressBook);
```

and

```
addressBook = filer.read();
```

For an **AddressBookStorage** to actually store an **AddressBook** object, it must know the file to which an address book is written or from which it is read. How should we let the programmer specify this file? One possibility is to let the programmer pass the filename to a constructor, such as

```
AddressBookStorage filer
 = new AddressBookStorage("book.data");
```

Another possibility is to define a method to set the file, say, **setFile**, which is called as

```
filer.setFile("book.data");
```

Instead of choosing one over the other, we will support both. If we don’t provide the **setFile** method, **filer** can input and output to a single file only. By using the **setFile** method, the programmer can change the file if she or he needs to. As for the constructor, we do not want to define a constructor with no argument because we do not want the programmer to create an **AddressBookStorage** object without specifying a filename. Yes, he or she can call the **setFile** method later, but as the **AddressBookStorage** class designer, we cannot ensure the programmer will call the **setFile** method. If the programmer doesn’t call the method, then the subsequent calls to the **write** or **read** method will fail. Some may consider assigning a default filename in a no-argument constructor. But what will be the default filename? No matter which filename we choose, there’s a possibility that a file with this filename already exists, which will cause the file to be erased. To make our class reliable, we will not provide a no-argument constructor.

We will implement the class in the following order:

develop-  
ment steps

1. Implement the constructor and the **setFile** method.
2. Implement the **write** method.
3. Implement the **read** method.
4. Finalize the class.

## 12.5 Sample Development—continued

This order of development follows a natural sequence. We begin with the constructor as usual. Since the constructor and the `setFile` method carry out similar operations, we will implement them together. We will identify necessary data members in this step. The second step is to implement the file output routine, because without being able to write an `AddressBook` object, we won't be able to test the file input routine. For the third step, we will implement the file input routine.

Step 1 Development: Constructor and `setFile`step 1  
design

In step 1, we will identify the data members and define a constructor to initialize them. We will also implement the `setFile` method, which should be very similar to the constructor.

We need `File`, `FileInputStream`, `FileOutputStream`, `ObjectInputStream`, and `ObjectOutputStream` objects to do object I/O. Should we define a data member for each type of object? This is certainly a possibility, but we should not use any unnecessary data members. We need `ObjectInputStream` and `ObjectOutputStream` objects only at the time the actual read and write operations take place. We can create these objects in the `read` and `write` methods, only when they are needed. Had we used data members for all those objects, we would need to create and assign objects every time the `setFile` method was called. But calling the `setFile` method does not necessarily mean the actual file I/O will take place. Consider the case where the user changes the filename before actually saving an address book to a file. This will result in calling the `setFile` method twice before doing the actual file I/O. To avoid this type of unnecessary repetition, we will use one data member only, a `String` variable `filename` to keep the filename. The `setFile` method simply assigns the parameter to this variable. The constructor can do the same by calling this `setFile` method.

step 1 code

At this point, we have only one data member:

```
//-----
// Data Members
//-----

private String filename; //name of the file to store
 //an AddressBook object
```

The `setFile` method assigns the parameter to the data member. The class is defined as follows:

```
/*
 Chapter 12 Sample Program: Address Book Storage
 File: AddressBookStorage.java
*/
class AddressBookStorage {
```

```

private String filename;

public AddressBookStorage (String filename) {
 setFile(filename);
}

public void setFile(String filename) {
 this.filename = filename;
 System.out.println("Inside setFile. Filename is " + filename);
 //TEMP
}
}

```

step 1 test

To test this class, we have included a temporary output statement inside the **setFile** method. We will write a test program to verify that we can create an **AddressBookStorage** object and use the **setFile** method correctly:

```

/*
 Chapter 12 Sample Program: Driver class to test
 the skeleton AddressBookStorage

 File: TestAddressBookStorage.java (Step 1)
*/

class TestAddressBookStorage {

 public static void main (String[] args) {

 AddressBookStorage fileManager;

 fileManager = new AddressBookStorage("one.data");
 fileManager.setFile("two.data");
 fileManager.setFile("three.data");

 }
}

```

### Step 2 Development: Implement the write Method

step 2  
design

In the second development step, we will implement the **write** method. From the data member **filename**, we will create an **ObjectOutputStream** object and write the parameter **AddressBook** object to it. A sequence of method calls to create an **ObjectOutputStream** object can throw an **IOException**, so we must either propagate it or handle it.

## 12.5 Sample Development—continued

Following the STO principle, the method will propagate the thrown exception. The responsibility of an **AddressBookStorage** object is to take care of file I/O for others. When there's an exception, the object will inform the caller about the exception and let the caller decide what to do about it.

step 2 code

Here's the step 2 code with the **write** method:

```

/*
 Chapter 12 Sample Program: The class that provides the
 file I/O for AddressBook

 File: AddressBookStorage.java
*/
import java.io.*;

class AddressBookStorage {
 ...

 public void write(AddressBook book) throws IOException {
 //first create an ObjectOutputStream
 File outFile = new File(filename);
 FileOutputStream outFileStream =
 new FileOutputStream(outFile);
 ObjectOutputStream outObjectStream =
 new ObjectOutputStream(outFileStream);

 //save the data to it
 outObjectStream.writeObject(book);

 //and close it
 outObjectStream.close();
 }
}

```

step 2 test

We will write a test program to verify that the data are saved to a file. Since we do not have a method to read the file contents yet, we can only verify at this point that the file is created and that this file has something in it. To do so, we run the following step 2 test program first. Then, using whatever tool available (e.g., Windows Explorer, DOS command **dir**, UNIX command **ls**, etc.), we check that the specified file exists and that the file size is greater than zero.

The step 2 test program is as follows (**TestAddressBookWrite** is now an instantiable main class):

```

/*
Chapter 12 Sample Program: Test the write method
File: TestAddressBookWrite.java
*/
import java.io.*;

class TestAddressBookWrite {
 AddressBook myBook;
 AddressBookStorage fileManager;

 public static void main(String[] args) throws IOException {
 TestAddressBookWrite tester = new TestAddressBookWrite(15);
 tester.write("book.data");
 }

 public TestAddressBookWrite(int N) {
 myBook = new AddressBookVer1(N);

 for (int i = 0; i < N; i++) {
 Person person = new Person("Ms. X" + i, 10, 'F');
 myBook.add(person);
 }
 }

 public void write(String filename) {
 fileManager = new AddressBookStorage(filename);

 try {
 fileManager.write(myBook);
 }
 catch (IOException e) {
 System.out.println("Error: IOException is thrown.");
 }
 }
}

```

We run the program several times with different sizes for the address book and verify that the resulting files have different sizes. Notice that we can verify only that the file is created to store an **AddressBook** object. We cannot verify that the object is saved properly until we are able to read the data back, which we will do in the next step.

## 12.5 Sample Development—continued

**Step 3 Development: Implement the read Method**step 3  
design

In the third development step, we will implement the **read** method. The method reads the **AddressBook** object saved in the file and returns this object to the caller. As with the **write** method, if there's an exception, this method will propagate it back to the caller and let the caller decide what to do to the thrown exception.

step 3 code

Here's the step 3 code with the **read** method:

```

/*
 Chapter 12 Sample Program: The class that provides the
 file I/O for AddressBook

 File: AddressBookStorage.java
*/
import java.io.*;
class AddressBookStorage {
 ...
 public AddressBook read() throws IOException {
 AddressBook book;

 //first create an ObjectInputStream
 File inFile = new File(filename);
 FileInputStream inFileStream =
 new FileInputStream(inFile);
 ObjectInputStream inObjectStream =
 new ObjectInputStream(inFileStream);

 try {
 //read the data from it
 book = (AddressBook) inObjectStream.readObject();
 }
 catch (ClassNotFoundException e) {
 book = null;
 System.out.println("Error: AddressBook class not found");
 }

 //and close it
 inObjectStream.close();

 //and return the object
 return book;
 }
 ...
}

```

## step 3 test

We will write a test program to verify that the data can be read back correctly from a file. To test the read operation, the file to read the data from must already exist. Instead of copying the data file created in step 2 to the step 3 folder, we will make this test program to save the data first by using the **TestAddressBookWrite** class. The step 3 test program is as follows:

```

/*
 Chapter 12 Sample Program: Test the read (and write) method
 File: TestAddressBookRead.java
*/

import java.io.*;

class TestAddressBookRead {
 AddressBook myBook;
 AddressBookStorage fileManager;

 public static void main(String[] args) throws IOException {
 TestAddressBookWrite writer = new TestAddressBookWrite(15);
 TestAddressBookRead reader = new TestAddressBookRead();

 writer.write("book.data");
 reader.read("book.data");

 reader.search("Ms. X5");
 }

 public void search(String name) {
 Person person;

 person = myBook.search(name);

 if (person != null) {
 System.out.print(person.getName() + " ");
 System.out.print(person.getAge() + " ");
 System.out.println(person.getGender() + "\n");
 }

 else {
 System.out.println("Error: object not found");
 }
 }

 public void read(String filename) {
 fileManager = new AddressBookStorage(filename);

 try {
 myBook = fileManager.read();
 }
 }
}

```



12.5 Sample Development—*continued*

```

 catch (IOException e) {
 System.out.println("Error: IOException is thrown.");
 }
 }
}

```

We run the program several times, changing the method body of **printout** to access different **Person** objects in the address book as necessary, and we verify that we can read the **Person** object in the file correctly. If you did Exercise 16 on page 615, then use the **getFirstPerson** and **getNextPerson** methods to access all **Person** objects in the address book.

**Step 4 Development: Finalize**

We finalize the program in the last step. We perform a critical review for finding any inconsistency or error in the methods, incomplete methods, places to add more comments, and so forth. And, as always, we will carry out the final test. As the result of the critical review and final testing, we may identify and wish to implement any additional features.

program  
review

final test

**S u m m a r y**

- A File object represents a file or a directory.
- An instance of the JFileChooser class is a file dialog that lets the user select a file to read data from or save data to.
- Various input and output stream classes are defined in the java.io package.
- Low-level file input and output read and write data 1 byte at a time.
- FileInputStream and FileOutputStream classes are used for low-level file I/O.
- High-level file input and output read and write data of primitive data type.
- DataInputStream and DataOutputStream classes are used for high-level file I/O.
- With text I/O, data are read and saved as strings.
- PrintWriter and BufferedReader classes are used for text I/O.
- The Scanner class can be used to input data from a text file.
- With object I/O, data are read and saved as objects.
- ObjectInputStream and ObjectOutputStream are used for object I/O.
- To be able to save objects to a file, the class they belong to must implement the Serializable interface.

- The standard classes described or used in this chapter are

|                  |                    |
|------------------|--------------------|
| File             | FileReader         |
| JFileChooser     | BufferedReader     |
| FileOutputStream | Scanner            |
| FileInputStream  | Serializable       |
| DataOutputStream | ObjectOutputStream |
| DataInputStream  | ObjectInputStream  |
| PrintWriter      |                    |

## Key Concepts

|              |                                       |
|--------------|---------------------------------------|
| file         | low-level I/O (bytes)                 |
| directory    | high-level I/O (primitive data types) |
| file dialog  | text I/O (strings)                    |
| streams      | object I/O (objects)                  |
| binary files | Serializable interface                |
| text files   |                                       |

## Chapter 12 Exercises

### Review Exercises

- What will happen if you forget to close a file?
- What is the difference between binary files and text files?
- Using the try-catch block, write a code fragment that opens a file `default.dat` when an attempt to open a user-designated file raises an exception.
- Using a `File` object, write a code fragment to display files in a user-specified directory.
- Write a code fragment to store and read the contents of the `payScaleTable` two-dimensional array from Section 10.5 in the following two file formats:
  - A file of double values
  - A file of two-dimensional array

### Level 1 Programming Exercises ★

- Write a program that inputs words from the user and save the entered words, one word per line, in a text file. The program terminates when the user enters the word `STOP` (case insensitive).
- Write a program that reads the words from the text file created by the program of Exercise 6. After the file content is read, display the shortest word, the longest word, and the average length of the words.

8. Repeat Exercise 6, but this time use an `ArrayList` of strings. Add all the words to the `ArrayList` and save the whole data as a single `ArrayList` object to an object file.
9. Repeat Exercise 7, but this time read the data from the object file created by the program of Exercise 8.
10. Write a program that randomly generates  $N$  integers and stores them in a binary file `integers.dat`. The value for  $N$  is input by the user. Open the file with a text editor and see what the contents of a binary file look like.
11. Write a program that reads the data from the file `integers.dat` generated in Exercise 10. After the data are read, display the smallest, the largest, and the average.
12. Repeat Exercise 10, but this time, store the numbers in a text file `integers.txt`. Open this file with a text editor and verify that you can read the contents.
13. Repeat Exercise 11 with the text file `integers.txt` generated in Exercise 12.

### Level 2 Programming Exercises ★★

14. Write a program that reads a text file and converts its content to an Eggy-Peggy text (see Exercise 25 of Chapter 9). Save the converted text to another text file. Use `JFileChooser` to let the user specify the input and output files. Create the input file by using a text editor.
15. Extend the `AddressBookStorage` class by adding import and export capabilities. Add a method `exportFile` that stores the contents of `AddressBook` to a text file. Add a second method `importFile` that reads the text file back and constructs an `AddressBook`. This type of import/export feature is a convenient means to move data from one application to another.
16. Extend the encryption application of Exercise 30 of Chapter 9 so that the original text is read from a user-specified text file and the encrypted text is stored to another user-specified text file.
17. Extend the watermelon projectile computation program of Exercise 31 of Chapter 6 so the output is saved to a file. Which file format would you use for the program, a binary file or a text file? Or would you consider using an array to keep the  $(x, y)$  coordinates and save this array by using an object I/O?
18. Extend Exercise 18 of Chapter 10 by reading the fortunes from a text file. Many different types of fortunes can be found at

```
http://www.chinese-fortune-cookie.com/
fortune-cookie-sayings.html
```

You can select, cut, and paste the list of fortunes into a text file using a text editor such as the Notepad on the Windows platform. Name this text file `fortunes.txt`. If the website has not changed the listing style, then fortunes are separated by single blank lines. When you input fortunes, you have to skip blank lines. If you don't do this, then half of the fortunes in a list are blank. An alternative is to remove the blank lines, so every line in the text file is a fortune. You can do this manually by using a text editor or write a separate program that inputs this text file and output another text file with

all blank lines removed. When the file is very large, then it pays to write a separate program.

19. Converting data in one format to another format is a very common programming task. In this exercise, you will input longitude and latitude information from a text file and output the data in KML (Keyhole Markup Language) format. KML is a file format used in Google Earth and Google Maps to record geometric annotation and visualization information. A complete information on KML can be found at

<http://earth.google.com/kml>

An input file is a text file that contains a sequence of longitude and latitude data in the following format:

```
-121.87 36.61
-3.02 16.77
34.75 139.76
...
```

Longitude and latitude data are separated by a blank space. The output file is also a text file with information saved in KML format. Here's an example:

```
<?xml version="1.0" encoding="UTF-8"?>
<kml xmlns="http://earth.google.com/kml/2.1">
<Document>
 <name>Mystery Locations</name>
 <Placemark>
 <name>Location 1</name>
 <Point>
 <coordinates>-121.87,36.61,0</coordinates>
 </Point>
 </Placemark>
 <Placemark>
 <name>Location 2</name>
 <Point>
 <coordinates>-3.02,16.77,0</coordinates>
 </Point>
 </Placemark>
</Document>
</kml>
```

The top and the bottom portions

```
<?xml version="1.0" encoding="UTF-8"?>
<kml xmlns="http://earth.google.com/kml/2.1">
<Document>
 <name>Mystery Locations</name>
 ...
</Document>
</kml>
```

are the same for all output files. For each longitude and latitude pair, you generate the corresponding `<Placemark>` section. For example, if the data values are `-3.02` and `16.67` for the second longitude/latitude pair, you generate

```
<Placemark>
 <name>Location 2</name>
 <Point>
 <coordinates>-3.02,16.77,0</coordinates>
 </Point>
</Placemark>
```

The values that are dependent on the input data are shown in red bold text for illustration purpose (it's a text file, so in the actual output, there's no such color output). Notice that there is always the output of 0 as the third value in the `<coordinates>` section. Indentation in the output file can be achieved by outputting the tab (`\t`) characters. Use `JFileChooser` to allow the user to specify the input and output files. Create your own test input files using a text editor. In addition to or in lieu of checking the correctness of your output files manually, you can use Google Earth. Open your output file from Google Earth. If your output KML file is correct, Google Earth will display a pushpin for each location (placemark) in the file. Google Earth is available for download from

<http://earth.google.com/download-earth.html>

20. A Web browser, such as the MS Internet Explorer and the Mozilla Firefox, reads an HTML file and displays the content. When you open the HTML file with a text editor, you will notice that it is simply a text file with special tags. For example, with Firefox, you can view the content of a Web page as a plain text by selecting the menu choice `View/Page Source`. A Web browser uses the information contained in the HTML tags to visually display the Web page. Write a program that inputs an HTML file as a text file and count the number of times the `LINK` tag occurs in the file. For this exercise, we assume that the `LINK` tag is preceded immediately by the less than symbol `<` as

```
<LINK
```

in a case insensitive manner.

21. Extend Exercise 20 by processing information in the `LINK` tags. One of the information contained in the `LINK` tag is the `href` attribute that refers to a linked Web page, such as

```
<LINK href="http://www.somewhere.com/info.html" />
```

Extend the program from Exercise 20 by extracting and displaying the Web addresses of the referenced pages. For the sample tag, you display the Web address

```
http://www.somewhere.com/info.html
```

The format for the href attribute is the text href (case insensitive) followed immediately by the equal symbol =. The Web address is surrounded by the double quotes.

22. Extend Exercise 21 by saving the Web addresses to a text file in addition to displaying them on the screen. Use JFileChooser to let the user specify the text file to save the Web addresses.

### Level 3 Programming Exercises ★★★

23. Write a program that inputs a document from a text file and saves the modified version to another text file. Modify the original document by replacing all occurrences of the word designated by the user with the text <BLACKED OUT>. Use JFileChooser to select the input and output text file and Scanner to input the word to replace from the user. For the text replacement operation, consider using the pattern matching techniques discussed in Chapter 9.

24. You need to know how to use Excel to do this exercise. At the website

<http://www.census.gov/genealogy/www/freqnames2k.html>

you will find a link to an Excel file that contains 1000 most popular last names from the 2000 Census. Extract only the names from this file and save them into a text file, one name per line. Write a program that allows the user to search the list of most popular last names by rank and by name. When the user enters a rank, the program displays the corresponding last name. For example, if the input is 2, then the program displays the 2nd most popular name, which is Johnson. If the user enters a name, then the program displays the name's rank. For example, if the user enters Miller, then the program displays its rank, which is 6.

25. Repeat Exercise 22 of Chapter 10, but this time, instead of supplying data values for the Element objects inside the program, read the data from a text file. Data on the elements in the periodic table can be found at

<ftp://ftp.nist.gov/pub/dataplot/other/reference/PERIODIC.TXT>

Remove the explanatory text from the beginning of the page and save the page as a text file starting from the first element

Hydrogen    H    1   1   1   1.0080   0.763   3.0   1300   -999

You only need to input the first six data values from each line. They are an element name, symbol, atomic number, period (row #), group (col#), and atomic weight. Each data item in a line is separated by one or more blank spaces.

### Development Exercises

For Exercises 26 through 30, use the incremental development methodology to implement the program. For each exercise, identify the program tasks, create

a design document with class descriptions, and draw the program diagram. Map out the development steps at the start. Present any design alternatives and justify your selection. Be sure to perform adequate testing at the end of each development step.

26. Write a currency converter application. Allow the user to specify the from and to currencies and the amount to exchange. Use the interface of your choice to input these three values. When the application starts, read the exchange rates from a text file `rate.txt`. Use a text editor to create this text file. By using a text file, you can easily update the exchange rates. The format for the text file is

```
<name of currency> <units per dollar>
```

For example, the following shows how much \$1 is worth in five foreign currencies:

```
French franc 5.95
Indonesian rupiah 12900.0
Japanese yen 123.91
Mexican peso 9.18
Papua New Guinea kina 2.381
```

You can get the exchange rates from various websites, one of which is <http://www.oanda.com>.

27. Extend any application you have written before by adding a quote-of-the-day dialog. When the user starts the application, a quote of the day is displayed. Save the quotes in a text file. Use a random number generator to select the quote to display. Notice the quotes can be about any information (many commercial applications start with a dialog that shows tips on using the software).
28. In Exercise 24 of Chapter 5 you wrote a drive-through ordering system for MyJava Lo-Carb Gourmet Sandwich (the company has since changed its name to reflect the current trend in the food industry). You are hired again as a freelance computer consultant to make extensions to the program.

Instead of having a fixed number of menu categories and a fixed number of menu items per category, you will input this information from a text file. The data in the input file have the following format:

```
#menu category
menu item $price
menu item $price
...
#menu category
menu item $price
```

Each menu category is preceded by the pound symbol (`#`). A list of menu items that belong to this menu category follows it. Each menu item includes

its name and price. The price is preceded by the dollar sign. Here's a sample input file:

```

#Entree
Tofu Burger $3.99
Chili Burger $2.99
Chef Salad $6.99

#Drink
Oolong Tea $0.79
Latte $3.29
House Wine $4.99
Chai Latte $2.50

#Side
Freedom Fries $0.99

#Appetizer
Onion Bloom $4.05
Calamari $3.50

```

You may assume that that input file contains at least one menu category and each menu category has at least one menu item. Also, you may assume that all input lines conform to the given format; that is, there will be no invalid input lines. Finally, there will be at most 20 menu categories and 25 menu items per menu category.

After the input file data are read into a program, the operation mode begins, where you continually process the customer orders. For each item on the menu, keep track of the sales. At the closing time, the store manager keys in a special code to shut down the program. Before stopping the program, output the sales figure in a format similar to the following:

Item	Sales Count	Total
Tofu Burger	25	\$ 87.25
Cajun Chicken	30	\$ 137.70
...		
Today's Total Sales:		\$ 2761.20

Place enough space between columns so the output is easy to read. You are not required to align the decimal points of the dollar figures. Output the sales figure to the standard output. Save the sales figure to a text file.



29. Write an application that removes extra spaces from a text file. In the days of the typewriter, it was common practice to leave two spaces after periods. We shouldn't be doing that anymore with the computer, but many people still do. Read an original text file and output an edited version to another text file. The edited version should replace two or more consecutive spaces with one space.
30. Write a mail merge application. You use two files for this program. The first is a text file that contains a template letter in the following style:

```
Dear <<N>>,

Because you are <<A>> years old and <<G>>, we have a
free gift for you. You have absolutely nothing to buy;
just pay the shipping and handling charge of $9.99. To
claim your gift, call us immediately.

Thank you,
Office of Claims Department
```

The tags <<N>>, <<A>>, and <<G>> are placeholders for the person's name, age, and gender. The second file contains the name, age, and gender information of people to whom you want to send a letter. Use whatever format you wish for the second file. Read two files and print out the letter with the placeholders replaced by the actual values from the second file. Run the program multiple times, each time using a different template file. For this program, output the personalized letter to a customized frame. Add menus to this frame so the user can save personalized letters to files (one personalized letter to a file).

# Inheritance and Polymorphism

# 13

## O b j e c t i v e s

---

*After you have read and studied this chapter, you should be able to*

- Write programs that are easily extensible and modifiable by applying polymorphism in program design.
- Define reusable classes based on inheritance and abstract classes and abstract methods.
- Differentiate the abstract classes and Java interface.
- Define methods, using the **protected** modifier.
- Parse strings, using a **StringTokenizer** object.

## Introduction



In this chapter, we will describe two important and powerful features in object-oriented programming—inheritance and polymorphism. The inheritance feature of object-oriented programming was introduced in Chapter 1. We will provide a more detailed explanation and examples of inheritance in this chapter.

polymorphism

The second major topic we cover in this chapter is *polymorphism*, another indispensable feature in object-oriented programming, which allows programmers to send the same message to objects from different classes. Consider the statement

```
account.computeMonthlyFee();
```

where `account` could be either a `SavingsAccount` or a `CheckingAccount` object. If `account` is a `SavingsAccount` object, then the method `computeMonthlyFee` defined for the `SavingsAccount` class is executed. Likewise, if `account` is a `CheckingAccount` object, then the method `computeMonthlyFee` defined for the `CheckingAccount` class is executed. Sending the same message therefore could result in executing different methods. The message `computeMonthlyFee` is called a *polymorphic message* because depending on the receiver object, different methods are executed. Polymorphism helps us write code that is easy to modify and extend. We will explain polymorphism in this chapter.

polymorphic message

### 13.1 | A Simple Example

Before we get into details, we start with a simple example of inheritance and polymorphism to give a taste of what's coming. Let's begin with a class that models a pet. We will purposely keep the class very simplistic (e.g., we're not including any constructor) to focus on inheritance mechanism. Here's the definition:

```
class Pet {
 private String name;

 public String getName() {
 return name;
 }

 public void setName(String petName) {
 name = petName;
 }

 public String speak() {
 return "I'm your cuddly little pet.";
 }
}
```

And here's a sample code that uses the class:

```
Pet myPet = new Pet();
System.out.println(myPet.speak());
```

There are many different types of pets, so we really can't expect one class to be capable of modeling them all. We all know how different dogs, cats, and reptiles are, for example. Let's define the individual Cat and Dog classes to model them a little more precisely than the generic Pet class. Now, instead of defining the two new classes independently, we will define them based on the Pet class. Although they are different, they share common traits of being a pet, so it makes sense to derive the two classes from the Pet class. This is inheritance. We'll make the Dog and Cat classes inherit the data members and methods of the Pet class.

Let's see how we might define the Cat class by using inheritance:

This indicates Cat is a subclass of Pet

```
class Cat extends Pet {
 public String speak() {
 return "Don't give me orders.\n" +
 "I speak only when I want to.";
 }
}
```

subclass  
superclass

We call the Cat class the *subclass* or *derived* class and the Pet class the *superclass* or *base* class. We use the reserved word `extends` to define a subclass. Data members and methods of a superclass are inherited by its subclasses. So, for example, the following code is valid:

```
Cat myCat = new Cat();
myCat.setName("Cha Cha");

System.out.println("Hi, my name is " + myCat.getName());
```

overrides

In the Cat class, we see that the body of the `speak` method is different. We say the Cat class *overrides* the `speak` method. For example, the code

```
Cat myCat = new Cat();
myCat.setName("Puff Puff");

System.out.println(myCat.getName() + " says: ");
System.out.println(myCat.speak());
```

will result in

```
Puff Puff says:
Don't give me orders. I speak only when I want to.
```

We can also define additional methods and data members to a subclass. The following Dog class defines an additional method named `fetch`:

```
class Dog extends Pet {
 public String fetch() {
 return "Yes, master. Fetch I will.";
 }
}
```

In addition to using all the inherited methods, we can call the fetch method if it is a dog:

```
Dog myDog = new Dog();
myDog.setName("Fifi");

System.out.println(myCat.getName() + " says: ");
System.out.println(myDog.speak());
System.out.println(myDog.fetch());
```

```
Fifi says:
I'my your cuddly little pet.
Yes, master. Fetch I will.
```

Now, consider the following code:

```
Pet petOne = new Dog();
Pet petTwo = new Cat();
```

Will it work? The answer is yes. When a variable (such as petOne) is declared to be of class S (such as Pet), the variable can be a reference to an instance of S or any of its subclasses (such as Dog and Cat). The inverse is not valid, for example:

```
Dog myDog = new Pet(); ← INVALID
```

The fact that the same variable can be referring to an instance of a different class results in polymorphism. The following two output statements will produce different results, depending on whether p is a Dog or a Cat:

```
Pet p;

p = new Dog();
System.out.println(p.speak());

p = new Cat();
System.out.println(p.speak());
```

polymorphic  
method

The speak method is called a *polymorphic method*.

If a variable is declared of type S and is referring to an instance of a subclass of S, then we must typecast the variable to the subclass when calling noninherited methods of the subclass. For example, the fetch method is defined in the Dog class only. So code such as

```
Pet p;

p = new Dog();
System.out.println(p.fetch()); ← INVALID
```

is invalid. We must typecast p to Dog, as in

```
Pet p;

p = new Dog();
System.out.println(((Dog)p).fetch());
```

Whenever we need to call a method unique to a subclass, we must typecast the variable to the subclass if the variable's declared type is the superclass.

To use inheritance and polymorphism effectively in our programs, we need to master many rules associated with them. We will present these rules in the remainder of the chapter.



1. Define the Reptile class as a subclass of the Pet class. The speak method returns an empty string.
2. Which one of the following statements is valid?

```
Pet p = new Cat();
Cat c = new Pet();
```

3. Is the following code valid?

```
Pet p = new Dog();
System.out.println(p.fetch());
```

## 13.2 Defining Classes with Inheritance

Suppose we want to maintain a class roster for a class whose enrolled students include both undergraduate and graduate students. For each student, we record her or his name, three test scores, and the final course grade. The final course grade, either pass or no pass, is determined by the following formula:

Type of Student	Grading Scheme
Undergraduate	Pass if $(\text{test1} + \text{test2} + \text{test3})/3 \geq 70$
Graduate	Pass if $(\text{test1} + \text{test2} + \text{test3})/3 \geq 80$

What kind of objects should we use to model undergraduate and graduate students? There are basically two broad ways to design the classes to model them. The first way is to define two unrelated classes, one for undergraduate students and another for graduate students. We call the two classes *unrelated classes* if they are not connected in an inheritance relationship, that is, if neither one is an ancestor

unrelated  
classes

or descendant class of the other and they do not share a common ancestor.<sup>1</sup> The second way is to model undergraduate and graduate students by using classes that are related in an inheritance hierarchy.

Defining two unrelated classes for entities that share common data or behavior would make class definition ineffective because we would end up duplicating code common to both classes. Although different, graduate and undergraduate students do share many common data and behaviors, so we will design these two classes by using inheritance.

We will actually define three classes. The first is the `Student` class to incorporate behavior and data common to both graduate and undergraduate students. The second and third classes are the `GraduateStudent` class to incorporate behavior specific to graduate students and the `UndergraduateStudent` class to incorporate behavior specific to undergraduate students. The `Student` class is defined as

```

/*
Chapter 13 Sample Program: Student
File: Student.java
*/
class Student {
 protected final static int NUM_OF_TESTS = 3;
 protected String name;
 protected int[] test;
 protected String courseGrade;
 public Student() {
 this("No Name");
 }
 public Student(String studentName) {
 name = studentName;
 test = new int[NUM_OF_TESTS];
 courseGrade = "****";
 }
 public String getCourseGrade() {
 return courseGrade;
 }
 public String getName() {
 return name;
 }
}

```

Protected fields are visible to the descendant objects.

<sup>1</sup>In Java, the class `Object` is automatically set to be the superclass of a class if the class definition does not include the keyword `extends`. To be technically precise, we must say that two classes are unrelated if they do not share a common ancestor besides `Object`.

```

public int getTestScore(int testNumber) {
 return test[testNumber-1];
}

public void setName(String newName) {
 name = newName;
}

public void setTestScore(int testNumber, int testScore) {
 test[testNumber-1] = testScore;
}

public void computeCourseGrade() {
 //do nothing - override this method in the subclass
}
}

```

Notice that the modifier for the instance variables is `protected`, making them visible and accessible from the instance methods of the class and the descendant classes. If you declare a data member of a class `private`, then this data member is accessible from the methods of the class only. If you declare a data member `public`, this data member is accessible from everywhere. We declare them `protected` so they are accessible from both the methods of the class and the descendant classes. We will explore further the `protected` modifier later in the chapter.

extends

We define the classes `UndergraduateStudent` and `GraduateStudent` as subclasses of the `Student` class. In Java, we say a subclass *extends* its superclass. The difference between the classes `GraduateStudent` and `UndergraduateStudent` lies in the way their final course grades are computed. The two subclasses are defined as follows:

```

class GraduateStudent extends Student {

 public void computeCourseGrade() {

 int total = 0;
 for (int i = 0; i < NUM_OF_TESTS; i++) {
 total += test[i];
 }

 if (total/NUM_OF_TESTS >= 80) {
 courseGrade = "Pass";
 } else {
 courseGrade = "No Pass";
 }
 }
}

```



```

class UndergraduateStudent extends Student {
 public void computeCourseGrade() {
 int total = 0;
 for (int i = 0; i < NUM_OF_TESTS; i++) {
 total += test[i];
 }
 if (total/NUM_OF_TESTS >= 70) {
 courseGrade = "Pass";
 } else {
 courseGrade = "No Pass";
 }
 }
}

```

Figure 13.1 shows the class diagram relating the three classes. Notice the use of the pound symbol (#) for the protected modifier. Notice also that we do not show inherited data members and methods in the subclasses. By seeing an inheritance arrow connecting a subclass to its superclass, we know that data members and methods indicated on the superclass are applicable to the subclasses also. We attach methods and data members to the subclasses only if they are defined in the subclasses or if they are overridden in the subclasses. In Figure 13.1, both subclasses have the method `computeCourseGrade` attached to them because the method is overridden in the subclasses.

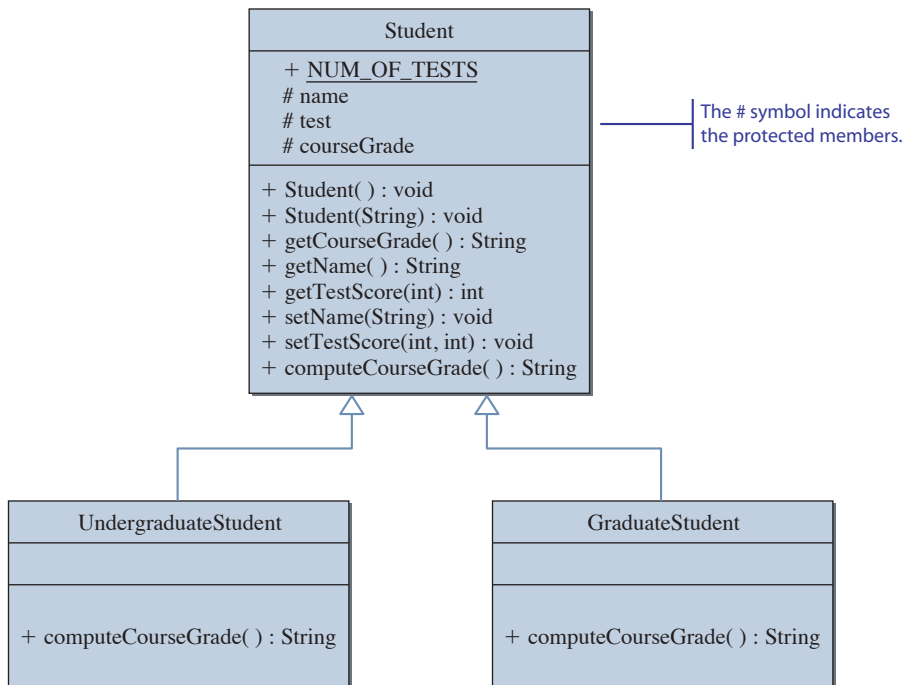

**Figure 13.1** A superclass **Student** and its subclasses **GraduateStudent** and **UndergraduateStudent**.

## Quick CHECK

1. Which is the subclass and which is the superclass in this declaration?  

```
class X extends Y { ... }
```
2. Which visibility modifier allows the data members of a superclass to be accessible to the instances of subclasses?

### 13.3 Using Classes Effectively with Polymorphism

Now let's see how the `Student` class and its subclasses can be used effectively in the class roster program. Since both undergraduate and graduate students are enrolled in a class, should we declare the two arrays shown below to maintain the class roster?

```
GraduateStudent gradRoster[20];
UndergraduateStudent undergradRoster[20];
```

We mentioned in Chapter 10 that an array must contain elements of the same data type. For example, we cannot store integers and real numbers in the same array. To follow this rule, it seems necessary for us to declare two separate arrays, one for graduate students and another for undergraduate students. This rule, however, does not apply when the array elements are objects. We only need to declare a single array, for example,

```
Student roster[40];
```

Elements of the roster array can be instances of either the `Student` class or any of its descendant `GraduateStudent` or `UndergraduateStudent` classes. Figure 13.2 illustrates the array with both types of students as array elements.

Before showing how this array is used in the program, we will explain the concept of polymorphism. In its simplest form, polymorphism allows a single

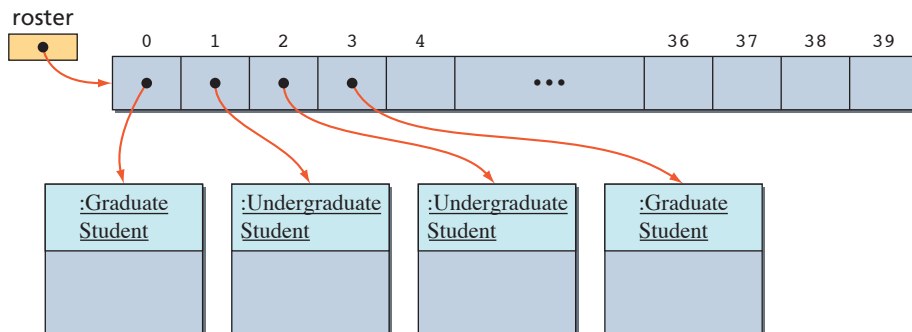

**Figure 13.2** The `roster` array with elements referring to instances of `GraduateStudent` or `UndergraduateStudent` classes.

variable to refer to objects from different classes. Consider, for example, the declaration

```
Student student;
```

With this declaration, we can say not only

```
student = new Student();
```

but also

```
student = new GraduateStudent();
```

or

```
student = new UndergraduateStudent();
```

In other words, the single variable `student` is not limited to referring to an object from the `Student` class but can refer to any object from the descendant classes of `Student`. In a similar manner we can say something like

```
roster[0] = new GraduateStudent();
roster[1] = new UndergraduateStudent();
roster[2] = new UndergraduateStudent();
roster[3] = new GraduateStudent();
...
```

sibling classes

However, you cannot make a variable of class `X` refer to an object from the superclass or sibling classes of `X`. *Sibling classes* are those that share the common ancestor class. For example, the following assignment statements are both invalid.

```
GraduateStudent grad1, grad2;
```

**X NOT VALID** → `grad1 = new Student( );`  
`grad2 = new UndergraduateStudent( );`

Now, to compute the course grade using the roster array, we execute

```
for (int i = 0; i < numberOfStudents; i++) {
 roster[i].computeCourseGrade();
}
```

If `roster[i]` refers to a `GraduateStudent`, then the `computeCourseGrade` method of the `GraduateStudent` class is executed; and if it refers to an `UndergraduateStudent`, then the `computeCourseGrade` method of `UndergraduateStudent` is executed. We call the message `computeCourseGrade` *polymorphic* because the message refers to methods from different classes depending on the object referenced by `roster[i]`. Polymorphism allows us to maintain the class roster with one array instead of

maintaining a separate array for each type of student, and this simplifies the processing tremendously.

Notice that the statement

```
roster[i].computeCourseGrade();
```

in the sample code works because we defined the `computeCourseGrade` method in the `Student` class. The method does nothing (its method body is empty), so its purpose may not be obvious. But without this method in the `Student` class, the statement would result in an error. We explained the reason at the end of Section 13.1. If the `computeCourseGrade` method were not defined in the `Student` class, then the method would be unique to the individual subclasses, requiring us to typecast the expression `roster[i]` to either `UndergraduateStudent` or `GraduateStudent`. Such typecasting, of course, cancels out the benefits of polymorphism. Instead of defining the `computeCourseGrade` method in the `Student` class with an empty body, we could define it as an *abstract* method. We will define an abstract method and explore its uses in Section 13.6.

benefits of  
polymorphism

Polymorphism makes possible smooth and easy extension and modification of a program. Suppose, for example, we have to add a third type of student, say, audit student, to the class roster program. If we have to define a separate array for each type of student, this extension forces us to define a new class and a third array for audit students. But with polymorphism, we only have to define a new subclass of `Student`. And as long as this new subclass includes the correct `computeCourseGrade` method, the for loop to compute the course grade for students remains the same. Without polymorphism, not only do we have to add the new code, but also we have to rewrite existing code to accommodate the change. With polymorphism, on the other hand, we don't have to touch the existing code. Modifying existing code is a tedious and error-prone activity. A slight change to existing code could cause a program to stop working correctly. To be certain that a change in one portion of existing code won't affect other portions of existing code adversely, we must understand the existing code completely. And understanding code, especially one that is long and/or written by somebody else, is a very time-consuming task.

An element of the roster array is a reference to an instance of either the `GraduateStudent` or the `UndergraduateStudent` class. Most of the time, we do not have to know which is which. There are times, however, when we need to know the class of a referenced object. For example, we may want to find out the number of undergraduate students who passed the course. To determine the class of an object, we use the `instanceof` operator. We use this operator as follows:

```
Student x = new UndergraduateStudent();

if (x instanceof UndergraduateStudent) {
 System.out.println("Mr. X is an undergraduate student");
} else {
 System.out.println("Mr. X is a graduate student");
}
```

This will print out Mr. X is an undergraduate student. The following code counts the number of undergraduate students in the roster array.

```
int undergradCount = 0;
for (int i = 0; i < numberOfStudents; i++) {
 if (roster[i] instanceof UndergraduateStudent) {
 undergradCount++;
 }
}
```



1. Suppose Truck and Motorcycle are subclasses of Vehicle. Which of these declarations are invalid?

```
Truck t = new Vehicle();
Vehicle v = new Truck();
Motorcycle m1 = new Vehicle();
Motorcycle m2 = new Truck();
```

2. What is the purpose of the instanceof operator?

## 13.4 | Inheritance and Member Accessibility

We will describe the rules of inheritance in this section and Sections 13.5 and 13.6. In this section, we will explain which members (variables and methods) of a superclass are inherited by a subclass and how these members are accessed. In addition to declaring members private and public, we can declare them protected. The protected modifier is meaningful when used with inheritance. Consider the following declarations:

```
package one;
class Super {
 public int public_Super_Field;
 protected int protected_Super_Field;
 private int private_Super_Field;

 public Super() {
 public_Super_Field = 10;
 protected_Super_Field = 20;
 private_Super_Field = 30;
 }
 ...
}
```

*super is a reserved word, so don't use it.*

```

package two;
import one.*;
class Sub extends Super {
 public int public_Sub_Field;
 protected int protected_Sub_Field;
 private int private_Sub_Field;

 public Sub() {
 public_Sub_Field = 100;
 protected_Sub_Field = 200;
 private_Sub_Field = 300;
 }
 ...
}

```

Notice that the two classes `Super` and `Sub` are placed in the separate packages. We need to place the `Sub` class in a package different from the package of its superclass to show the effect of the `protected` modifier. If both the superclass and the subclass are in the same package, the `protected` modifier has no effect (it behaves the same as the `public` modifier).

We use instance variables for illustration, but the rules we describe here are equally applicable to other types of members (class variables, class methods, and instance methods). We use the graphical representation shown in Figure 13.3 for the three modifiers.

You already know the difference between the `public` and `private` modifiers. A `public` member is accessible from everywhere, but a `private` member is accessible

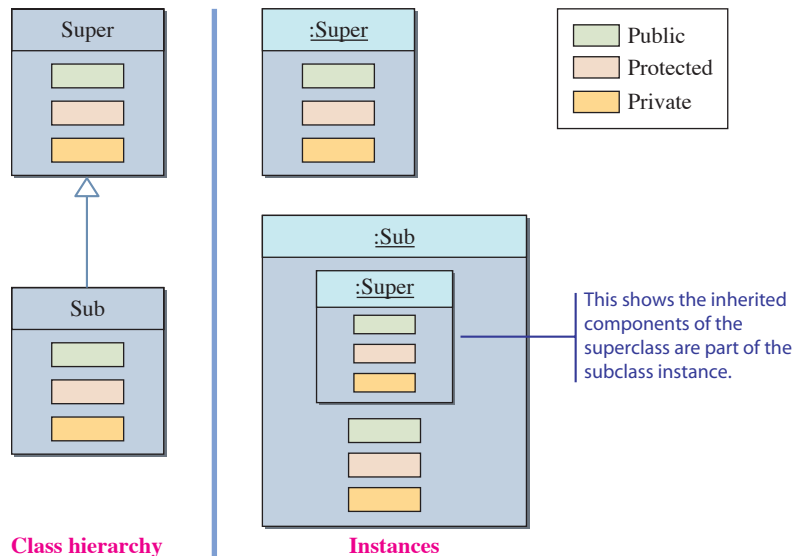

**Figure 13.3** A graphical representation of superclasses and subclasses with **public**, **private**, and **protected** members. (Note: This representation is for illustration purposes only and is not a formal UML diagram.)

only within the same class. Let's illustrate this point. Consider a class that is unrelated to the classes Super and Sub:

```

import one.*;
import two.*;

class Client {
 public void test() {
 Super mySuper = new Super();
 Sub mySub = new Sub();

 int i = mySuper.public_Super_Field;
 int j = mySub.public_Super_Field; //inherited
 //by mySub
 int k = mySub.public_Sub_Field;
 }
}

```

✓ VALID →

Public members of a class, whether they are inherited or not, are accessible from any object or class. Private members of a class, on the other hand, are never accessible from any outside object or class. The following statements, if placed in the test method of the Client class, are therefore all invalid:

```

int l = mySuper.private_Super_Field;
int m = mySub.private_Super_Field;
int n = mySub.private_Sub_Field;

```

✗ NOT VALID →

A protected member can be accessed from the classes in the same package and the subclasses in other packages. It is not accessible from the unrelated classes in other packages. The following statements, if placed in the test method of the Client class, are all invalid:

```

int o = mySuper.protected_Super_Field;
int p = mySub.protected_Super_Field;
int q = mySub.protected_Sub_Field;

```

✗ NOT VALID →

Figure 13.4 summarizes the accessibility of class members from a method of an unrelated class in a different package.

Now let's study the accessibility of class members from the methods of a Sub object. A method in the Sub object can access both the protected and public members of Super, but not the private members of Super. Figure 13.5 summarizes the accessibility of members from a method of a Sub object.

Figure 13.5 shows the case where a method of a Sub object is accessing members of itself. Everything except the private members of the Super class is accessible from a method of the Sub class.

What about accessing the members of an object from another object that belongs to the same class? If a member X, whether inherited or defined in a class, is accessible from an instance of the class, then X is also accessible from all instances of the same class. Figure 13.6 illustrates that an instance can access members of other instances of the same class.

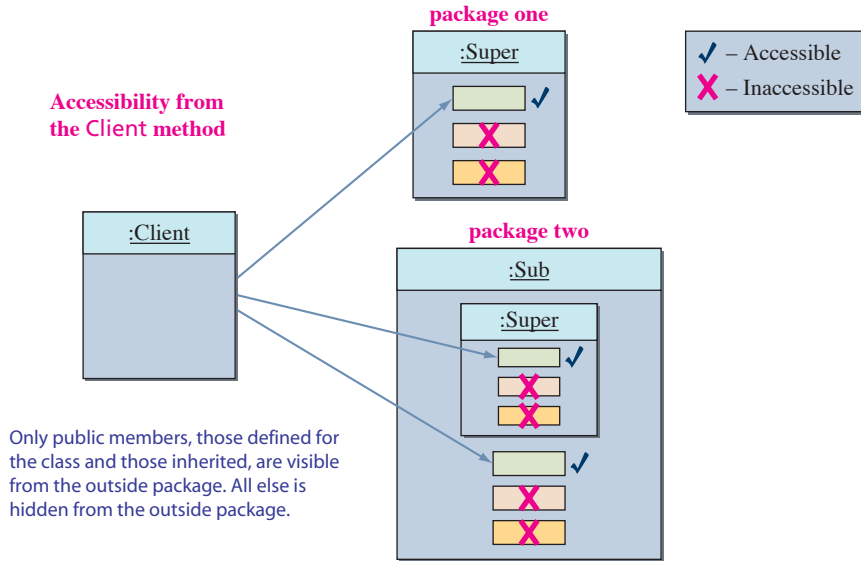

**Figure 13.4** The difference between **public**, **private**, and **protected** modifiers. Only public members are visible from outside.

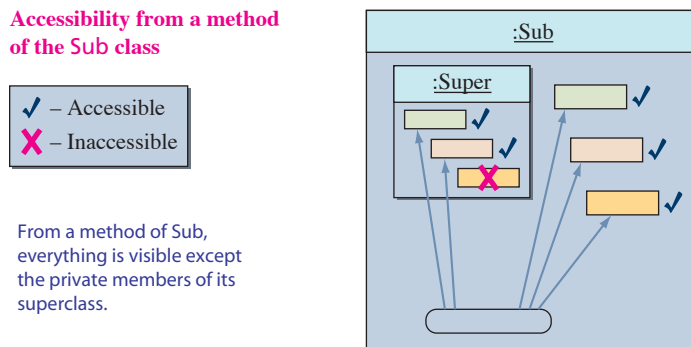

**Figure 13.5** The difference between **public**, **private**, and **protected** modifiers. Everything except the **private** members of the **Super** class is visible from a method of the **Sub** class.

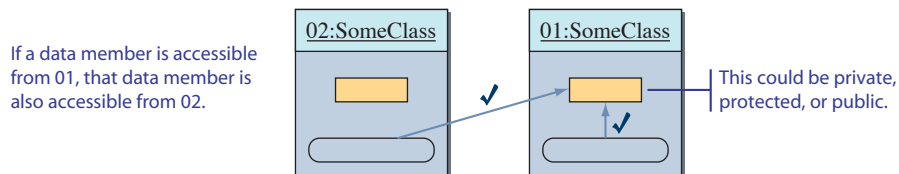

**Figure 13.6** Data members accessible from an instance are also accessible from other instances of the same class.



Consider the following two methods in the Super and Sub classes:

```

class Super {
 ...
 public void superToSuper(Super anotherSuper){
 int i = anotherSuper.public_Super_Field;
 int j = anotherSuper.protected_Super_Field;
 int l = anotherSuper.private_Super_Field;
 }
 ...
}

class Sub extends Super {
 ...
 public void subToSub(Sub anotherSub){
 int i = anotherSub.public_Sub_Field;
 int j = anotherSub.protected_Sub_Field;
 int k = anotherSub.private_Sub_Field;
 int l = anotherSub.public_Super_Field; //inherited
 int m = anotherSub.protected_Super_Field; //members
 X NOT VALID → int n = anotherSub.private_Super_Field;
 }
 ...
}

```

All the statements in the two methods, except the last one in `subToSub`, are valid because members accessible to an object are also accessible from other objects of the same class.

### Hints, & Tips, Pitfalls



In addition to the **private**, **protected**, and **public** modifiers, Java supports the fourth visibility modifier, called *package visibility*. If no explicit modifier (**public**, **private**, and **protected**) is included in the declaration, then the component is package-visible, which means the component is accessible from any class that belongs to the same package as the component's class. Likewise, protected-visible components are accessible to any classes in the same package, but they are also accessible to all subclasses outside the package. Package-visible components are inaccessible to any classes outside the package, so the protected visibility is less restrictive than the package visibility.

## Quick CHECK



1. If X is a private member of the Super class, is X accessible from a subclass of Super?
2. If X is a protected member of the Super class, is X of one instance accessible from another instance of Super? What about from the instances of a subclass of Super?

### 13.5 | Inheritance and Constructors

In this section, we explain the connection between the constructors of a class and the inheritance mechanism. Unlike other members of a superclass, constructors of a superclass are not inherited by its subclasses. This means that you must define a constructor for a class or use the default constructor added by the compiler. As we mentioned in Chapter 4, a default constructor is added to a class if you do not declare any constructor for the class. A class definition such as

```
class Person {
 public void sayHello() {
 System.out.println("Well, hello.");
 }
}
```

is equivalent to

```
class Person {
 public Person() {
 super();
 }
 public void sayHello() {
 System.out.println("Well, hello.");
 }
}
```

Automatically added to the class by the compiler →

← This statement calls the superclass's constructor.

The statement

```
super();
```

calls the superclass's constructor. Every class has a superclass. If the class declaration does not explicitly designate the superclass with the extends clause, then the class's superclass is the Object class.

If you declare a constructor, then no default constructor is added to the class. For example, if you define a class as

```
class MyClass {
 public MyClass(int x) {
 ...
 }
}
```

then a statement such as

```
MyClass test = new MyClass();
```

is invalid because `MyClass` has no matching constructor.

If the constructor you define does not contain an explicit call to a superclass constructor, then the compiler adds the statement

```
super();
```

as the first statement of the constructor. For example, if you define a constructor as

```
class MyClass {
 private int myInt;
 public MyClass() {
 myInt = 10;
 }
}
```

then the compiler will rewrite the constructor to

```
public MyClass() {
 super();
 myInt = 10;
}
```

Let's look at another example. Consider the following class definitions:

```
class Vehicle {
 private String vin;
 public Vehicle(String vehicleIdNumber) {
 vin = vehicleIdNumber;
 }
}
```

```

 public String getVIN() {
 return vin;
 }
}

```

Since the class has a constructor, no default constructor is added to the class. This means a statement such as

```
Vehicle myCar = new Vehicle();
```

causes a compilation error because the class does not have a matching constructor. This is actually what we want because we do not want to create an instance of `Vehicle` without a vehicle identification number. Now let's consider a subclass definition for trucks. A `Truck` object has one additional instance variable called `cargoWeightLimit` that refers to a maximum weight of cargo the truck can carry. We assume the truck's weight limit for cargo can vary (say, depending on how much the owner pays in fees). Here's our first attempt:

```

class Truck extends Vehicle {
 private int cargoWeightLimit;
 public void setWeightLimit(int newLimit) {
 cargoWeightLimit = newLimit;
 }
 public int getWeightLimit() {
 return cargoWeightLimit;
 }
}

```

If we compile this definition, we will get a compiler error. Since no constructor is defined for the class, the compiler adds a default constructor

```

public void Truck() {
 super();
}

```

This constructor calls the superclass's constructor with no arguments, but there's no matching constructor in the superclass. Thus, the compilation error results. Here's a correct definition:

```

class Truck extends Vehicle {
 private int cargoWeightLimit;
 public Truck(int weightLimit, String vin) {
 super(vin);
 cargoWeightLimit = weightLimit;
 }
 public void setWeightLimit(int newLimit) {

```

You need to make this call. Otherwise, the compiler will add `super()`, which will result in an error because there is no matching constructor in `Vehicle`.

```

 cargoWeightLimit = newLimit;
 }

 public int getWeightLimit() {
 return cargoWeightLimit;
 }
}

```

Now let's apply this knowledge to the design of the `UndergraduateStudent` and `GraduateStudent` classes. If we want a constructor that accepts the name, then we need to define such a constructor in both classes because the constructor defined for the `Student` class is not inherited by these classes. Notice that we can create instances of these classes by

```

student1 = new UndergraduateStudent();
student2 = new GraduateStudent();

```

because the default constructor is added by the compiler, not because the one defined in the `Student` class is inherited by the subclasses. Remember that constructors of a superclass are not inherited by its subclasses.

Here are a rule and a guideline to remember for a subclass constructor:

### Design Guidelines



***If a class has a superclass that is not the `Object` class, then include an explicit call to a constructor of the superclass in the constructor of the class.***

### Design Guidelines



***Always provide a constructor for every class you define. Don't rely on default constructors.***



1. How do you call the superclass's constructor from its subclass?
2. What statement will be added to a constructor of a subclass if it is not included in the constructor explicitly by the programmer?
3. Modify the definition of `GraduateStudent` and `UndergraduateStudent` in Section 13.1 so we can create their instances in this way:

```

student1 = new UndergraduateStudent();
student2 = new UndergraduateStudent("Mr. Espresso");
student3 = new GraduateStudent();
student4 = new GraduateStudent("Ms. Latte");

```

## 13.6 Abstract Superclasses and Abstract Methods

When we define a superclass, we often do not need to create any instances of the superclass. In Section 13.5, we defined the `Student` superclass and its two subclasses `GraduateStudent` and `UndergraduateStudent`. We gave examples of creating instances of `GraduateStudent` and `UndergraduateStudent`, but not of creating instances of `Student`. Does it make sense to create an instance of the `Student` class? Depending on whether we need to create instances of `Student`, we must define the class differently. We will describe different ways of defining a superclass in this section.

Even though we can create an instance of `Student` if we want to (because of the way the class is currently defined), is there a need to create an instance of `Student`? If a student can be only a graduate or an undergraduate student, then there is no need to create an instance of `Student`. In fact, because of the way the class is defined, had we created an instance of `Student` and stored it in the roster array, the program would crash. Why? Because the `Student` class does not have a `computeCourseGrade` method.

In the following discussion, we will consider two cases. In the first case, we assume that a student must be either a graduate or an undergraduate student. In the second case, we assume that a student does not have to be a graduate or an undergraduate student (e.g., the student could be a nonmatriculated auditing student).

### Case 1: Student Must Be Undergraduate or Graduate

For the case where a student must be a graduate or an undergraduate student, we only need instances of `GraduateStudent` and `UndergraduateStudent`. So we must define the `Student` class in such a way that no instances of it can be created. One way is to define `Student` as an abstract class. An *abstract class* is a class defined with the modifier `abstract`, and no instances can be created from an abstract class. Let's see how the abstract `Student` class is defined.

abstract class

The keyword `abstract` here denotes an abstract class.

The keyword `abstract` here denotes an abstract method.

```

abstract class Student {
 protected final static int NUM_OF_TESTS = 3;
 protected String name;
 protected int[] test;
 protected String courseGrade;

 public Student() {
 this("No name");
 }

 public Student(String studentName) {
 name = studentName;
 test = new int[NUM_OF_TESTS];
 courseGrade = "*****";
 }

 abstract public void computeCourseGrade();
 }

```

Abstract method has no method body, just a semicolon.

```

 public String getCourseGrade() {
 return courseGrade;
 }

 public String getName() {
 return name;
 }

 public int getTestScore(int testNumber) {
 return test[testNumber-1];
 }

 public void setName(String newName) {
 name = newName;
 }

 public void setTestScore(int testNumber, int testScore){
 test[testNumber-1] = testScore;
 }
}

```

abstract  
method

implementing  
a method

An *abstract method* is a method with the keyword `abstract`, and it ends with a semicolon instead of a method body. A class is *abstract* if the class contains an abstract method or does not provide an implementation of an inherited abstract method. We say a method is *implemented* if it has a method body. If a subclass has no abstract methods and no unimplemented inherited abstract methods (and does not include the keyword `abstract` in its class definition), then the subclass is no longer abstract, and thus its instances can be created.

An abstract class must include the keyword `abstract` in its definition. Notice that the abstract class `Student` has an incomplete definition because the class includes the abstract method `computeCourseGrade` that does not have a method body. The intent is to let its subclasses provide the implementation of the `computeCourseGrade` method. If a subclass does not provide an implementation of the inherited abstract method, the subclass is also an abstract class, and therefore, no instances of the subclass can be created. Since an abstract class can only make sense when it is a superclass, we frequently use the term *abstract superclass*.

abstract  
superclass

### Hints, & Tips, Pitfalls



Is the **Math** class an abstract class? It is true that we cannot create an instance of the **Math** class, but it is not an abstract class. If a class is abstract, then you cannot create an instance of the class, but not being able to create an instance does not necessarily imply that the class is abstract. The intent of an abstract class is to define code common to all its subclasses and leave some portions, that is, abstract methods, to be completed by the individual subclasses. We classify the **Math** class as a noninstantiable class, a class for which we cannot create an instance. Notice that an abstract class is a noninstantiable class by definition, but the reverse is not always true. There are noninstantiable classes, for example, the **Math** class, that are not abstract. If you want to define a noninstantiable class, then simply declare a private constructor with no arguments and declare no other constructors for the class.

In a program diagram, we represent an abstract class by using the keyword `abstract`. The `Student` abstract superclass is drawn as

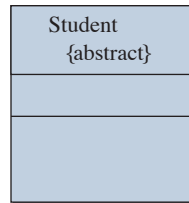

### Case 2: Student Does Not Have to Be Undergraduate or Graduate

For the second case, where a student does not have to be a graduate or an undergraduate student, we can design classes in two different ways. The first approach is to make the `Student` class instantiable. The second approach is to leave the `Student` class abstract and add a third subclass, say, `OtherStudent`, to handle a student who is neither a graduate nor an undergraduate student. Let's call students who are neither graduate nor undergraduate students *nonregular students*. Let's assume further that the nonregular student will receive a pass grade if her or his average test score is greater than or equal to 50. With the first approach, we define the `Student` class as

Not an abstract  
class anymore

```

class Student {
 protected final static int NUM_OF_TESTS = 3;
 protected String name;
 protected int[] test;
 protected String courseGrade;

 public Student() {
 this("No name");
 }

 public Student(String studentName) {
 name = studentName;
 test = new int[NUM_OF_TESTS];
 courseGrade = "*****";
 }

 public void computeCourseGrade() {
 int total = 0;
 for (int i = 0; i < NUM_OF_TESTS; i++) {
 total += test[i];
 }

 if (total/NUM_OF_TESTS >= 50) {
 courseGrade = "Pass";
 } else {

```

Not an abstract  
method anymore



```

 courseGrade = "No Pass";
 }
}

public String getCourseGrade() {
 return courseGrade;
}

public String getName() {
 return name;
}

public int getTestScore(int testNumber) {
 return test[testNumber-1];
}

public void setName(String newName) {
 name = newName;
}

public void setTestScore(int testNumber, int testScore) {
 test[testNumber-1] = testScore;
}
}
}

```

The class is no longer abstract, and we can create an instance of `Student` to represent a nonregular student.

With the second approach, we leave the `Student` class abstract. To represent nonregular students, we define a third subclass called `OtherStudent` as follows:

```

class OtherStudent extends Student {

 public void computeCourseGrade() {

 int total = 0;
 for (int i = 0; i < NUM_OF_TESTS; i++) {
 total += test[i];
 }

 if (total/NUM_OF_TESTS >= 50) {
 courseGrade = "Pass";
 } else {
 courseGrade = "No Pass";
 }
 }
}
}

```

Figure 13.7 is a program diagram that includes the third subclass.

Which approach is better? There's no easy answer. It all depends on a given situation. To determine which approach is better for a given situation, we can ask ourselves which approach allows easier modification and extension. Consider, for

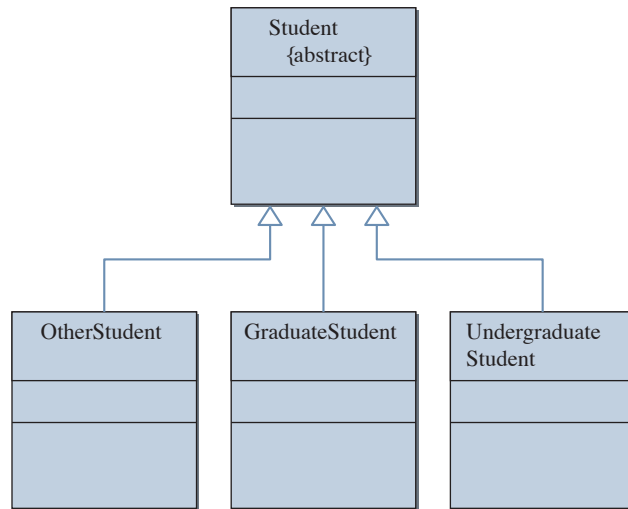

**Figure 13.7** A program diagram of the abstract superclass **Student** and its three subclasses.

example, which approach will facilitate easier modification if we have to add a new type of student, say, scholarship students. Or consider the case where the rule for assigning a course grade for the undergraduate and graduate students is modified; say, they become the same.

Finally, not all methods can be declared **abstract**. Specifically, private methods and class methods (of all visibility modifiers) cannot be abstract.

### Things to Remember



The following types of methods cannot be declared as **abstract**:

- Private methods
- Class methods (regardless of their visibility modifiers)

### Quick CHECK



1. Can you create an instance of an abstract class?
2. Must an abstract class include an abstract method?
3. What is wrong with the following declaration?

```

class Vehicle {
 abstract public getVIN();
 ...
}

```

### 13.7 | Inheritance versus Interface

Java interface and inheritance are language features used to support object-oriented modeling. They are similar because they are both used to model an IS-A relationship. Consider, for example, the following class definitions:

```
class AddressBookVer1 implements AddressBook {
 ...
}

class SavingsAccount extends Account {
 ...
}
```

We say “AddressBookVer1 is an AddressBook” and “SavingsAccount is an Account.” Because of this similarity, beginning programmers often have some difficulty in differentiating the two clearly. Although they are similar, their intended uses are quite different.

We use the Java interface to share common behavior (defined by its abstract methods) among the instances of unrelated classes. And one class can implement multiple interfaces. For example, we can define a single Person class that implements multiple interfaces such as Driver, Commuter, and Biker.

We use inheritance, on the other hand, to share common code (including both data members and methods) among the instances of related classes. And a single subclass can extend at most one superclass. For example, the GraduateStudent and UndergraduateStudent classes are subclasses of the Student class, the Truck and Motorcycle classes are subclasses of the Vehicle class, and so forth. The superclasses include data members and/or methods that are shared by the subclasses. The IS-A relationship that exists between a subclass and its superclass is a specialization, as Truck is a specialized Vehicle. Such a specialization relationship does not exist with the Java interface.

#### Design Guidelines



**Use the Java interface to share common behavior. Use the inheritance to share common code.**

#### Design Guidelines



**If an entity A is a specialized form of another entity B, then model them by using inheritance. Declare A as a subclass of B.**

We must be careful not to mix up the use of service class and inheritance. Beginners often make this mistake. Suppose you want to define a class that maintains a list of music CDs. Which of the following two definitions is a better design?

```
class CDManager extends java.util.ArrayList {
 ...
}
class CDManager {
 private List list;
 ..
}
```

The first version uses inheritance and defines a subclass of `ArrayList`. The second version defines a data member of type `ArrayList`. The first version is a misuse of inheritance. When we define a subclass A of superclass B, we must ask ourselves, Is A a B? Can we say `CDManager` is an `ArrayList`? No. The `CDManager` is not a specialized version of the `ArrayList`. The `CDManager` class simply needs to reuse the service provided by the `ArrayList` class. Thus, the second version is the proper design. We call this type of code reuse *code reuse by composition*.

code reuse by  
composition

Beyond the conceptual problem, defining the `CDManager` class as a subclass of `ArrayList` has practical weaknesses. Because it is a subclass, the client of the `CDManager` class can call any methods defined in the superclass `ArrayList`. But does it make sense for the client to call the method such as `ensureCapacity`? Another weakness is the difficulty in changing the implementation of the `CDManager` class. Suppose we need to modify the data structure class from `ArrayList` to `HashMap` for better performance. With the inheritance approach, any client that uses the inherited methods of `ArrayList` needs to be rewritten. With the composition approach, the client that uses only the methods defined for the `CDManager` class will continue to work without change. The change made from the `ArrayList` class to the `HashMap` class is encapsulated in the `CDManager` class and does not affect the clients.

## 13.8 Sample Development

### Computing Course Grades

Let's develop a program that illustrates the use of **Student** and its subclasses **GraduateStudent** and **UndergraduateStudent**. The program will input student data from a user-designated text file, compute the course grades, and display the results. We assume the input text file is created by using a text editor or another application. For example, a teacher may have kept his student grades in a notebook. Instead of manually computing the grades with a pencil and calculator, he enters data into a text file and uses this program to compute the course grades. Another possible scenario is that the teacher uses some kind of application software that allows him to maintain student records. Suppose this application does not allow the teacher to use different formulas for computing the course grades of undergraduate and graduate students. In such a case, the teacher can

## 13.8 Sample Development—continued

export data to a text file and use our program to compute the course grades for undergraduate and graduate students using the different formulas. Using text files to transfer data from one application to another application is a very common technique in software applications.

To focus on the use of inheritance and polymorphism, we will adopt the basic input and output routines. It is left as exercises to implement them differently. Exercise 9 asks you to save the data to an object file and Exercise 10 asks you to use the **Scanner** class for input.

### Problem Statement

Write an application that reads in a text file organized in the manner shown below and displays the final course grades. The course grades are computed differently for the undergraduate and graduate students based on the formulas listed on page 717. The input text file format is as follows:

- A single line is used for information on one student.
- Each line uses the format

`<Type> <Name> <Test 1> <Test 2> <Test 3>`

where `<Type>` designates either a graduate or an undergraduate student, `<Name>` designates the student's first and last name, and `<Test i>` designates the *i*th test score.

- End of input is designated by the word `END`. The case of the letters is insignificant.

Figure 13.8 shows a sample input text file.

### Overall Plan

We will implement a class that will

1. Read an input text file.
2. Compute the course grades.
3. Print out the result.

<code>&lt;Type&gt;</code>	<code>&lt;Name&gt;</code>	<code>&lt;Test 1&gt;</code>	<code>&lt;Test 2&gt;</code>	<code>&lt;Test 3&gt;</code>
U	John Doe	87	78	90
G	Jill Jones	90	95	87
G	Jack Smith	67	77	68
U	Mary Hines	80	85	80
U	Mick Taylor	76	69	79
END				

**Figure 13.8** A sample text file containing student names and test scores. **U** at the beginning of a line designates an undergraduate student, and **G** designates a graduate student.

To read a text file, we will use the standard file I/O objects **File**, **FileReader**, and **BufferedReader**. To compute the course grades, we will use the **Student**, **Undergraduate**, and **Graduate** classes defined earlier in the chapter. The formulas for calculating the course grades are defined in their respective **computeCourseGrades** methods. Since the input file is a text file, we must create either a **Graduate** or an **Undergraduate** object for each line of input, so we will be able to call its **computeCourseGrades** method. To store the created student objects (instances of either **Graduate** or **Undergraduate**), we will use an array of **Student** to gain more practice on using arrays.

To focus on the inheritance and polymorphism topics, we will use two helper classes. The first is the **OutputBox** class which we use to display the course grades and save the result back to a text file. We use its **print** and **println** methods for output and its **saveToFile** method to save the data to a text file. The **saveToFile** method saves the complete text in an **OutputBox** to a designated file. If the file already exists, then the original contents of the file will be replaced by the text currently shown in the **OutputBox**. Often, we need the capability to save the text in different format. For example, assuming the student information includes the student ID number, the teacher may want to save only the last four digits of the ID numbers and the final course grades so the results can be posted. If we wish to save the text in a different format, then we have to implement our own method with such capability.

The second helper class is the **MainWindow** class. We will name our main class **ComputeGrades**, and as another example of inheritance, we make it a subclass of **MainWindow**. The **MainWindow** is itself a subclass of **JFrame** and has the functionality of positioning itself at the center of the screen (among other features). We cover the details of subclassing the **JFrame** class in Chapter 14.

Here's our working design document:

program  
classes

Design Document: ComputeGrades	
<b>Class</b> ComputeGrades	<b>Purpose</b> The top-level control object manages other objects in the program. The class is a subclass of the helper class <code>MainWindow</code> . This class is the instantiable main class.
OutputBox	An <code>OutputBox</code> object is used to display the input data and computed course grades.
Student, UndergraduateStudent, GraduateStudent	These are application logic objects for students. The <code>Student</code> class is an abstract superclass.
File, FileReader, BufferedReader	These are objects necessary for reading data from a text file.

## 13.8 Sample Development—continued

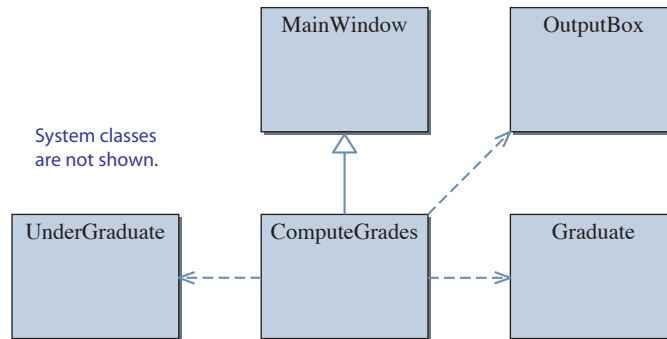

**Figure 13.9** An object diagram of the **ComputeGrades** program.

Figure 13.9 is the program diagram.

Now let's think about the methods of **ComputeGrades**. What kinds of public methods should the class support? Since a **ComputeGrades** object is a top-level controller object. Let's define a single public method called **processData** to carry out the three main tasks. The **main** method of **ComputeGrades** will call this method.

```

public static void main(String[] args) {
 ComputeGrades gradeComputer = new ComputeGrades();
 gradeComputer.processData();
}

```

The **processData** method will look something like this:

```

this.setVisible(true); //make this main window
outputBox.setVisible(true); //and an outputBox visible

boolean success = readData();

if (success) {
 computeGrade();
 printResult();
} else {
 print error message "File Input Error";
}

```

The **readData** method returns **true** if the input data are read in correctly from a text file and the array of **Student** objects is properly created. Our working design

document for the **ComputeGrades** class is as follows:

Design Document: The ComputeGrades Class		
Method	Visibility	Purpose
<constructor>	public	Creates and initializes the objects used by a ComputeGrades object.
processData	public	Displays itself and carries out three main tasks.
readData	private	Opens and reads data from a text file and creates an array of Student objects from the input data. If the operation is successful, returns true.
computeGrade	private	Scans through the array of Student objects and computes the course grades.
printResult	private	Prints out the student information along with the computed grades to an OutputBox.

We will develop the program in five incremental steps:

1. Start with the program skeleton. Define the skeleton **ComputeGrades** classes.
2. Implement the **printResult** method. Define any other methods necessary to implement **printResult**.
3. Implement the **computeGrade** method. Define any other methods necessary to implement **computeGrade**.
4. Implement the **readData** method. Define any other methods necessary to implement **readData**.
5. Finalize and look for improvements.

We defer the implementation of the hardest method, **readData**, until the last. Some programmers prefer to deal with the hardest aspect of the program first, and there's no strict rule for ordering the implementation steps. You should order the steps in a way with which you are most comfortable. However, this does not mean you can implement the methods at random. You must always plan the implementation steps carefully so the steps follow a logical sequence. For this program, we start with the output routine so we can use it when testing other methods, instead of defining a temporary (and throw-away) output routine for testing purposes.

### Step 1 Development: Program Skeleton

Let's begin with the data members and the constructors for the **ComputeGrades** class. We will start with the following data members:

```
private OutputBox outputBox; //for output
private Student[] roster; //for maintaining
 //student info
```

step 1  
design



## 13.8 Sample Development—continued

It is a straightforward operation to create the first four objects, but we need to think a little about the **roster** array. How big should the array be? There are several possibilities:

1. Create an array of an arbitrary size, say, 25.
2. Let the programmer pass the size in the constructor.
3. Do not create it in the constructor. Modify the input text file to include the size of an array in the first line.

Option 3 is not attractive because it will require a change in the problem specification. Moreover, requiring the size information in the input file will put a lot of burden on the user who must go over the text file and count the number of lines the file contains. Such a burdensome task should be left to a computer. So we will implement options 1 and 2. If the data cannot fit into an array of a predesignated size, then we will use the technique discussed in Chapter 10 to expand the array. (Notice that we are using an array where for pedagogical reasons. We can use a list such as **ArrayList** or **LinkedList** instead. Using a list for maintaining a roster is left as an exercise.)

We declare a constant

```
private static final int DEFAULT_SIZE = 25;
```

and declare the two constructors as

```
public ComputeGrades() {
 this(DEFAULT_SIZE);
}
public ComputeGrades(int arraySize) {
 super(); //an explicit call to the superclass constructor
 outputBox = new OutputBox(this);
 roster = new Student[arraySize];
}
```

Notice that we can't create **inFile**, **fileReader**, and **bufReader** until we know the actual file to open. We will create these objects in one of the methods we define later.

For the skeleton program, we include temporary output statements in the private methods to verify that they are called correctly in the right order. Here's the skeleton:

step 1 code

```
/*
 Chapter 13 Sample Development: Compute Grades for Undergraduate
 and Graduate Students
 File: ComputeGrades.java
*/
```

```
//----- STEP 1 -----//
class ComputeGrades extends MainWindow {

 private static final int DEFAULT_SIZE = 25;

 private OutputBox outputBox;

 private Student[] roster;

 public ComputeGrades() {
 this (DEFAULT_SIZE);
 }

 public ComputeGrades(int arraySize) {
 super(); // an explicit call to the superclass constructor

 outputBox = new OutputBox(this);

 roster = new Student[arraySize];
 }

//-----
// Main
//-----
 public static void main(String[] args) {
 ComputeGrades gradeComputer = new ComputeGrades();
 gradeComputer.processData();
 }

 public void processData() {
 this.setVisible(true);
 outputBox.setVisible(true);

 boolean success = readData();

 if (success) {
 computeGrade();
 printResult();
 } else {
 outputBox.println("File Input Error");
 }
 }

 private void computeGrade() {

 outputBox.println("Inside computeGrade"); //TEMP
 }

 private void printResult() {

 outputBox.println("Inside printResult"); //TEMP
 }
}
```

## 13.8 Sample Development—continued

```
private boolean readData() {
 outputBox.println("Inside readData"); //TEMP
 return true;
}
}
```

step 1 test

We execute the skeleton main class **ComputeGrades** for verification. When it is executed, we will see the top-level frame window (**ComputeGrades**) and an **OutputBox** appearing on the screen and the following messages in the **OutputBox**:

```
Inside readData
Inside computeGrade
Inside printResult
```

**Step 2 Development: Implement the printResult Method**step 2  
design

In the second development step, we add a routine that places the result in an **outputBox**. To implement and test this method, we need to create the **roster** array. We will include temporary code inside the **readData** method to build a test **roster** array. We can use **for** loops as in

```

 for (int i = 0; i < 15; i++) {
 roster[i] = new UndergraduateStudent();
 roster[i].setName("Undergrad # " + i);

 roster[i].setTestScore(1, 70 + i);
 roster[i].setTestScore(2, 75 + i);
 roster[i].setTestScore(3, 80 + i);
 }

 for (int i = 15; i < DEFAULT_SIZE; i++) {
 roster[i] = new GraduateStudent();
 roster[i].setName("Grad # " + i);

 roster[i].setTestScore(1, 80 + i);
 roster[i].setTestScore(2, 85 + i);
 roster[i].setTestScore(3, 90 + i);
 }

```

The first half of the array is undergraduate students.

The second half of the array is graduate students.

to create a temporary **roster** for testing purposes.

Now, let's design the **printResult** method. When this method is called, we have the **roster** array built. The method scans through the array and retrieves the student data, using the **getName**, **getCourseGrade**, and **getTestScore** methods. Expressed in pseudocode, we have the following:

```
for each element i in the roster array {
 output the name of roster[i];
 output the test scores of roster[i];
 output the course grade of roster[i];
 skip to the next line;
}
```

How should we terminate the loop? We should realize first that the **roster** array may or may not be full. For example, its default size is 25, but the actual number of elements may be less than 25, so using the value of **roster.length** will not work. Since **roster** is an array of objects, one possible way to express the loop is as follows:

```
while (roster[i] != null) {
 //output roster[i] information
}
```

One problem with this **while** loop is that we must have at least one empty slot in the array for the loop to terminate correctly. We can improve it by using the **length** value as

```
while (i < roster.length && roster[i] != null) {
 ...
}
```

If we use the for-each loop, then we have the following:

```
for (Student s: roster) {
 if (s == null) break;
 //output s information
}
```

Another possibility is to keep the count, which we set in the **readData** method. This count will be a data member of type **int**. Let's call this count variable **studentCount**. Then the processing loop becomes

```
for (int i = 0; i < studentCount; i++) {
 //output roster[i] information
}
```

We will adopt this approach because having this count information is useful for other purposes. For example, if we want to compute the percentage of students passing the course, we can use **studentCount** to compute it. If we don't have this variable, then every

## 13.8 Sample Development—continued

time we need to compute the percentage, we have to find out the number of students in the **roster** array.

Finally, to print out student information so the data will align properly, we will output the control character `\t` (for tab). For a simple output like this, sending tabs to output will work fine. For a more elaborate output, we can use the formatting technique discussed in Chapter 6.

step 2 code

Here's the step 2 code. Notice we add the declaration for a new data member **studentCount**, and this data member is initialized to 0 in the constructor.

```

/*
 Chapter 13 Sample Development: Compute Grades for Undergraduate
 and Graduate Students

 File: ComputeGrades.java
*/
//----- STEP 2 -----//
class ComputeGrades extends MainWindow {
 ...
 private int studentCount;
 ...
 public ComputeGrades(int arraySize) {
 ...
 studentCount = 0;
 }
 ...

 private void printResult() {
 for (int i = 0; i < studentCount; i++) {
 //print one student
 outputBox.print (roster[i].getName());

 for (int testNum = 1; testNum <= Student.NUM_OF_TESTS;
 testNum++) {
 outputBox.print("\t" + roster[i].getTestScore (testNum));
 }
 outputBox.println("\t" + roster[i].getCourseGrade());
 }
 }
}

```

```

private boolean readData() {
 outputBox.println("Inside readData"); //TEMP

 //TEMP
 // Create a temporary roster array to
 // test the printResult method.
 //
 for (int i = 0; i < 15; i++) {
 roster[i] = new UndergraduateStudent();
 roster[i].setName("Undergrad # " + i);

 roster[i].setTestScore(1, 70 + i);
 roster[i].setTestScore(2, 80 + i);
 roster[i].setTestScore(3, 90 + i);
 }
 for (int i = 15; i < DEFAULT_SIZE; i++) {
 roster[i] = new GraduateStudent();
 roster[i].setName("Grad # " + i);

 roster[i].setTestScore(1, 80 + i);
 roster[i].setTestScore(2, 85 + i);
 roster[i].setTestScore(3, 90 + i);
 }

 studentCount = DEFAULT_SIZE;
 return true;
}
}
}

```

#### step 2 test

We verify two items in this step. First, the temporary **readData** method includes creating student objects and calling their methods. Correct execution will verify that we are including the correct student classes and using their methods properly. Second, the **printResult** method should display the output as intended. Since we have not implemented the **computeGrade** method, we will see four asterisks for the course grades. We have to run the program several times and adjust the display format. Also, it is important to try different values for names and test scores before moving to the next step.

#### Step 3 Development: Implement the computeGrade Method

#### step 3 design

The functionality of computing the course grades is embedded inside the student classes, specifically, inside the respective **computeCourseGrade** methods of the **GraduateStudent** and **UndergraduateStudent** classes. Therefore, all we need to do in the **computeGrade** method is to scan through the **roster** array and call the element's **computeCourseGrade** method. This simplicity is a direct result of polymorphism.

## 13.8 Sample Development—continued

step 3 code

Here's the listing. The only addition is the **computeGrade** method.

```

/*
 Chapter 13 Sample Development: Compute Grades for Undergraduate
 and Graduate Students

 File: ComputeGrades.java
*/
//----- STEP 3 -----//
class ComputeGrades extends MainWindow {
 ...
 private void computeGrade() {
 for (int i = 0; i < studentCount; i++) {
 roster[i].computeCourseGrade();
 }
 }
 ...
}

```

step 3 test

We repeat the same testing routines of step 2. Instead of seeing four asterisks for the course grades, we should be seeing correct values. To make the verification easy, we can set the fixed test scores for all students. Make sure you assign test scores that will result in students both passing and not passing. Don't forget to try out end cases such as zero for all three test scores. What about negative test scores? Will the **Student** classes handle them correctly? If we identify serious problems with the **Student** classes at this point, we may have to suspend our development until we correct the **Student** class.

**Step 4 Development: Implement the readData Method**step 4  
design

We will now design the core function of the class, the **readData** method. We can express the overall logic of the method in pseudocode as

```

get the filename from the user;
if (the filename is provided)
 read in data and build the roster array;

```

```
else
 output an error message;
```

We will use a **JFileChooser** object from the standard **javax.swing** package to let the user specify the file. If the user cancels this dialog, then **null** is returned. In this case, we print out an error message and stop. If the user specifies a file, then we pass this information to a private method **buildRoster**, which will read data from the designated file and build the **roster** array.

The **buildRoster** method will read one line of data from the designated file at a time, and for each line of data, it creates an appropriate student object (an instance of **GraduateStudent** if the type is **G** and an instance of **UndergraduateStudent** if the type is **U**). The counter **studentCount** is incremented by 1 after each line is processed. When the line contains the terminator **END**, the method completes its execution. If the data in a line do not conform to the designated format, then the line is ignored. The method, expressed in pseudocode, is as follows:

```
try {
 set bufReader for input;
 while (!done) {
 line = get next line;

 if (line is END) {
 done = true;
 } else {
 student = createStudent(line);

 if (student != null) {
 roster[studentCount] = student;
 //add to roster

 studentCount++;
 }
 }
 }
} catch (IOException e) {
 output an error message;
}
```

**createStudent** will return **null** if **line** does not conform to the designated format.

We use the **try-catch** block because the creation of the **BufferedReader** object **bufReader** from a given filename could result in an exception. We can use the **Scanner** class instead of the **FileReader** and **BufferedReader** classes. We create a **Scanner** object by passing a **File** object to the constructor.

The **createStudent** method accepts a **String** argument, which is one line of the input file, and returns an instance of either **GraduateStudent** or **UndergraduateStudent** depending on the type specified in the line. If there's an error in the input line, then **createStudent** returns **null**. Instead of terminating the whole program, we will simply ignore the lines that do not conform to the specified format.



## 13.8 Sample Development—continued

In a very simplified form, the **createStudent** method looks like this:

```

type = first element of inputLine;
if (type.equals(UNDER_GRAD) || type.equals(GRAD)) {
 student = newStudentWithData(inputLine);
} else { //invalid type is encountered
 student = null;
}
return student;

```

**newStudentWithData** will return **null** if **inputLine** contains invalid data.

The top statement requires us to extract the first item in the input line (**String**). How should we do it? The **newStudentWithData** method, which creates an instance of **GraduateStudent** or **UndergraduateStudent** and assigns data to it, also requires an operation to extract individual elements of data from a single line. We can write our own string processing routine to parse a given line and extract data on type, name, and test scores, but there's a better solution. We can use a standard class called **StringTokenizer** from the **java.util** package. We will take a quick detour to explain this class. Instead of using the **StringTokenizer** class, we could use the pattern-matching techniques with the **Pattern** and **Matcher** classes. Yet another approach is to create a **Scanner** object for each line of text, but this will result in creating say, 1000 **Scanner** objects when the input file contains 1000 lines of text. This is inefficient. The use of **StringTokenizer** class is more appropriate in a case such as this, where we need to extract tokens from a given string. And, we only need to create exactly one **StringTokenizer** object to process the input file.

## String-Tokenizer

A **StringTokenizer** object is used to extract tokens from a given string. A *token* is a string of characters separated by *delimiter characters*, or simply *delimiters*. Any character can be designated as a delimiter, but space is the most commonly used delimiter. By default, a **StringTokenizer** object uses a white space (blank, tab, new line, or return) as its delimiter. Here's an example. The following code

```

String inputString
 = "I drink 100 cups of coffee every morning.";
StringTokenizer parser = new StringTokenizer(inputString);
while (parser.hasMoreTokens()) {
 System.out.println(parser.nextToken());
}

```

will print out

```

I
drink
100
cups

```

```

of
coffee
every
morning.

```

The **hasMoreTokens** method returns **true** if there are more tokens remaining in **parser**, and the **nextToken** method returns the next token in **parser**. The **nextToken** method throws a **NoSuchElementException** if there is no token to return. Please refer to a **java.util** reference manual for more information on **StringTokenizer**.

### Hints, & Tips, Pitfalls



It's great if you already know about **StringTokenizer**, but if you don't, you're out of luck. You would end up programming the functionality of **StringTokenizer** yourself, redoing something that has been done already. That's always a challenge for everybody, not just for beginners. Whenever you encounter a situation that seems to call for a common programming task, first look up the Java API reference manuals. You also can ask your classmates, teaching assistant, or instructor for guidance. They may know something. You should also make a habit of browsing the Java API reference manuals so you will have general knowledge about the standard classes. The key is always to look for the existing classes to reuse.

Now let's get back to the design. Using a **StringTokenizer** object, we can express the **createStudent** method as

```

StringTokenizer parser = new StringTokenizer(line);
String type;

try {
 type = parser.nextToken();

 if (type.equals(UNDER_GRAD) || type.equals(GRAD)) {
 student = newStudentWithData(type, parser);
 } else { //invalid type is encountered
 student = null;
 }

} catch (NoSuchElementException e) { //no token
 student = null;
}
return student;

```

A private **newStudentWithData** method accepts a **String** that specifies the type of student and a **StringTokenizer** object. The method creates an instance of

## 13.8 Sample Development—continued

**UndergraduateStudent** or **GraduateStudent** and assigns data to the object by calling the **StringTokenizer** object's **nextToken** method repeatedly:

```
//type and parser are the parameters
try {
 if (type.equals(UNDER_GRAD)) {
 student = new UndergraduateStudent();
 } else {
 student = new GraduateStudent();
 }

 set the student name //use parser.nextToken() to
 //extract data from a line

 set the student test scores
} catch (Exception e) { //thrown by parser.nextToken() or
 student = null; //Integer.parseInt(...)
}

return student;
```

Our design document for the **ComputeGrades** class now includes three more private methods:

Design Document: The <b>ComputeGrades</b> Class		
Method	Visibility	Purpose
...	...	...
buildRoster	private	Reads one line of data from the designated file at a time; and for each line of data, creates an appropriate student object. If the data in a line do not conform to the designated format, then the line is ignored.
createStudent	private	Creates a student object by calling <code>newStudentWithData</code> if the type in the input line is U or G. If successful, returns the created student; otherwise, returns null.
newStudentWithData	private	Creates an instance of <code>UndergraduateStudent</code> or <code>GraduateStudent</code> and assigns data to the object by calling the <code>StringTokenizer</code> object's <code>nextToken</code> method repeatedly.

step 4 code

Here's the complete step 4 code:

```

/*
 Chapter 13 Sample Development: Compute Grades for Undergraduate
 and Graduate Students

 File: ComputeGrades.java
*/

import java.io.*;
import java.util.*;
import javax.swing.*;

//----- STEP 4 -----//
class ComputeGrades extends MainWindow {

 private static final int DEFAULT_SIZE = 25;

 private static final String UNDER_GRAD = "U";
 private static final String GRAD = "G";
 private static final String END_OF_FILE_STR = "END";

 private OutputBox outputBox;
 private Student[] roster;
 private int studentCount;

 public ComputeGrades() {
 this (DEFAULT_SIZE);
 }

 public ComputeGrades(int arraySize) {
 super(); // an explicit call to the superclass constructor

 outputBox = new OutputBox(this);

 roster = new Student[arraySize];

 studentCount = 0;
 }

 //-----
 // Main
 //-----

 public static void main(String[] args) {
 ComputeGrades gradeComputer = new ComputeGrades();
 gradeComputer.processData();
 }

 public void processData() {
 setVisible(true);
 outputBox.setVisible(true);
 }
}

```

## 13.8 Sample Development—continued

```

 boolean success = readData();

 if (success) {
 computeGrade();
 printResult();
 } else {
 outputBox.println("File Input Error");
 }
}

private boolean buildRoster(String filename) {
 String inputLine;
 Student student;

 File inFile;
 FileReader fileReader;
 BufferedReader bufReader;

 boolean status = true;
 boolean done = false;

 try {
 inFile = new File(filename);
 fileReader = new FileReader(inFile);
 bufReader = new BufferedReader(fileReader);

 while (!done) {

 inputLine = bufReader.readLine(); //read one line

 if (inputLine.equalsIgnoreCase(END_OF_FILE_STR)) {
 done = true;
 }
 else {
 student = createStudent(inputLine);

 if (student != null) {
 roster[studentCount] = student;
 studentCount++;
 }
 }
 } // while

 bufReader.close();
 }
 catch (IOException e) {
 status = false;
 }
}

```

```

 return status;
 }

 private void computeGrade() {
 for (int i = 0; i < studentCount; i++) {
 roster[i].computeCourseGrade();
 }
 }

 private Student createStudent(String line) {
 Student student;
 StringTokenizer parser = new StringTokenizer(line);
 String type;

 try {
 type = parser.nextToken();

 if (type.equals(UNDER_GRAD) || type.equals(GRAD)) {
 student = newStudentWithData(type, parser);
 } else {
 student = null;
 }
 } catch (NoSuchElementException e) { //no token
 student = null;
 }

 return student;
 }

 private Student newStudentWithData(String type,
 StringTokenizer parser) {
 Student student;

 try {
 if (type.equals(UNDER_GRAD)) {
 student = new UndergraduateStudent();
 } else {
 student = new GraduateStudent();
 }

 //set the student name
 String firstName = parser.nextToken();
 String lastName = parser.nextToken();

 student.setName(firstName + " " + lastName);

 //set the student test scores
 for (int testNum = 1; testNum <= Student.NUM_OF_TESTS;
 testNum++) {

```

## 13.8 Sample Development—continued

```

 student.setTestScore(testNum, Integer.parseInt(
 parser.nextToken()));
 }
} catch (Exception e) { //either parser.nextToken() or
 //Integer.parseInt(...) thrown exception
 student = null;
}
return student;
}
private void printResult() {
 for (int i = 0; i < studentCount; i++) (
 //print one student
 outputBox.print (roster[i].getName());
 for (int testNum = 1; testNum <= Student.NUM_OF_TESTS;
 testNum++) {
 outputBox.print("\t" + roster[i].getTestScore (testNum));
 }
 outputBox.println("\t" + roster[i].getCourseGrade());
 }
}
private boolean readData() {
 //get file to open
 JFileChooser fileChooser = new JFileChooser(".");
 //start the listing from the current directory
 int returnVal = fileChooser.showOpenDialog(this);
 boolean result = false;
 if(returnVal == JFileChooser.APPROVE_OPTION) {
 String filename
 = fileChooser.getSelectedFile().getAbsolutePath();
 if (filename != null) {
 result = buildRoster(filename);
 }
 }
 return result;
}
}

```

## step 4 test

We run through a more complete testing routine in this step. We need to run the program for various types of input files. Some of the possible file contents are as follows:

Step 4 Test Data	
Test File	Purpose
File with 5 to 20 entries of student information with all lines in correct format	Test the normal case.
File with 5 to 20 entries of student information with some lines in incorrect format	Test that <code>readData</code> and supporting methods handle the error case properly.
File with no entries	Test that <code>buildRoster</code> method handles the error case properly.
File with more than 25 entries	Test that <code>readData</code> and supporting methods handle the case where the number of entries is larger than the default size for the roster array.

## program review

### Step 5 Development: Finalize and Improve

As always, we will finalize the program by correcting any remaining errors, inconsistency, or unfinished methods. We also look for improvement in the last step. One improvement we can always look for relates to the length of the methods. Although there are no hard rules for the length, a method should not be any longer than a single page. The `buildRoster` and `newStudentWithData` methods are close to the maximum. If we notice the method is getting longer in the coding stage, we may want to rethink our design. For example, if the `buildRoster` method becomes too big, then we can define a new method that takes care of a portion of the method, such as moving the **if-then-else** statement in the method to a new method.

One problem that remains (which would have been identified in step 4 testing) is the missing method for expanding the `roster` array when the input file includes more student entries than the set default size of 25. We leave this method as Exercise 3. We also leave some of the possible improvements as exercises.

## Summary

- Inheritance and polymorphism are powerful language features to develop extensible and modifiable code.
- Inheritance mechanism is used to share common code among the related classes.
- Inheritance is different from the Java interface, which is used to share common behavior among unrelated classes.



- The third visibility modifier is the protected modifier.
- If no instances are created from a superclass, then define the superclass as an abstract class.
- Polymorphic messages tell us that the method executed in response to the message will vary according to the class to which the object belongs.
- The first statement in a constructor of a subclass must be a call to a constructor of the superclass. If the required statement is not made explicitly, then the statement to call the default constructor of the superclass is inserted automatically by the Java compiler.
- The standard class described or used in this chapter is StringTokenizer.

## Key Concepts

superclass and subclass	abstract superclass
inheritance	abstract methods
inheritance and constructors	polymorphism
inheritance and visibility modifiers	inheritance versus interface

## Chapter 13 Exercises

### Review Exercises

1. Consider the following class definitions. Identify invalid statements.

```

class Car {
 public String make;
 protected int weight;
 private String color;
 ...
}

class ElectricCar extends Car {
 private int rechargeHour;
 public ElectricCar() {
 ...
 }
 //copy constructor
 public ElectricCar (ElectricCar car) {
 this.make = car.make;
 this.weight = car.weight;
 this.color = new String(car.color);
 this.rechargeHour= car.rechargeHour;
 }
 ...
}

```

```

class TestMain {
 public static void main (String[] args) {
 Car myCar;
 ElectricCar myElecCar;

 myCar = new Car();
 myCar.make = "Chevy";
 myCar.weight = 1000;
 myCar.color = "Red";

 myElecCar = new ElectricCar();
 myCar.make = "Chevy";
 myCar.weight = 500;
 myCar.color = "Silver";
 }
}

```

2. Consider the following class definitions. Identify which calls to the constructor are invalid.

```

class Car {
 public String make;
 protected int weight;
 private String color;

 private Car (String make, int weight, String color) {
 this.make = make;
 this.weight = weight;
 this.color = color;
 }

 public Car () {
 this("unknown", -1, "white");
 }
}

class ElectricCar extends Car {
 private int rechargeHour;

 public ElectricCar() {
 this(10);
 }

 private ElectricCar(int charge) {
 super();
 rechargeHour = charge;
 }
}

class TestMain {
 public static void main (String[] args) {

 Car myCar1, myCar2;
 ElectricCar myElec1, myElec2;
 }
}

```

```

 myCar1 = new Car();
 myCar2 = new Car("Ford", 1200, "Green");

 myElec1 = new ElectricCar();
 myElec2 = new ElectricCar(15);
 }
}

```

3. How would you modify the ComputeGrades sample program if the formula for computing the course grade were different for freshman, sophomore, junior, and senior undergraduate students? Would you design four subclasses of UndergraduateStudent? Or would you modify the body of the computeCourseGrade method of UndergraduateStudent? Discuss the pros and cons of each approach.

### Level 1 Programming Exercises ★

4. Write a program that creates an ArrayList of pets. An item in the list is either a Dog or a Cat. For each pet, enter its name and type ('c' for cat and 'd' for dog). Stop the input when the string STOP is entered for the name. After the input is complete, output the name and type for each pet in the list.
5. Repeat Exercise 4, but this time group the output by printing out the names of all cats first and then the names of all dogs.

### Level 2 Programming Exercises ★★

6. Modify the Dog class to include a new instance variable weight (double) and the Cat class to include a new instance variable coatColor (string). Add the corresponding accessors and mutators for the new instance variables. Modify Exercise 4 by inputting additional information appropriate for the type. First you input name and type, as before. If the type is a cat, then input its coat color. If the type is a dog, then input its weight. After the input is complete, output the name, type, and coat color for the cats and the name, type, and weight for the dogs.
7. In the ComputeGrades sample program, we set the default size of the roster array to 25. Modify the program so the size of the array will be increased if the input file contains more than 25 students. You need to add a method that expands the array, say by 50 percent. The technique to expand an array was discussed in Chapter 10.
8. Modify the ComputeGrades sample program by using a list (ArrayList or LinkedList) instead of an array.
9. Extend the ComputeGrades sample program by storing the roster array using an object file. Give an option to the user to read the data from a text file (this is how the original ComputeGrades works) or an object file. Similarly, give an option to the user to save the data to a textfile or an object file.
10. Modify the ComputeGrades sample program to input the data from a text file using the Scanner class instead of the FileReader and BufferedReader classes.

Use the tab character (t) as the delimiter. You create one Scanner object for the whole file. Assume the data in the file is correct.

### Level 3 Programming Exercises ★★★

11. In the Chapter 5 sample development, we defined the DrawableShape class that includes a method to draw one of the three possible shapes—rectangle, rounded rectangle, or ellipse. Modify the DrawableShape class as a super class of the three subclasses Rectangle, RoundedRectangle, and Ellipse. The actual drawing of a shape is done by the drawShape method defined in each of the three subclasses. Using the DrawingBoard helper class from Chapter 5 and the four classes defined in this exercise, write a screensaver program that draws 10 rectangles, 15 rounded rectangles, and 20 ellipses of various sizes. All shapes will move smoothly across the screen.
12. Suppose you have a list of Dog and Cat objects from Exercise 6 and want to find the average, minimum, and maximum weight of dogs. To compute these values, you must scan the whole list. It would be more efficient if you could get the results by traversing only Dog objects in the list. One approach to achieve this improvement is to create another list that includes only Dog objects (actually references to Dog objects). Here's an example:

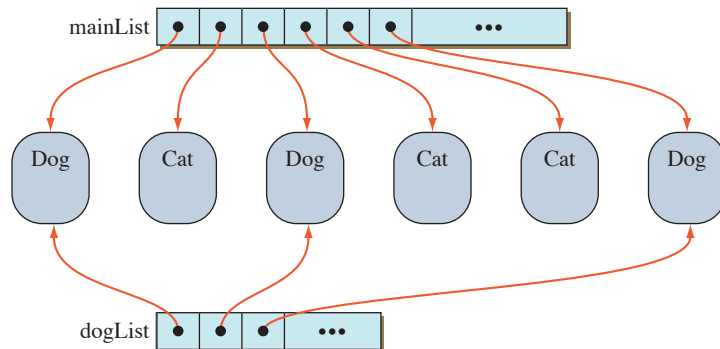

Repeat Exercise 6, but this time create the additional dog list. Then find the average, minimum, and maximum weights of the dogs by traversing the dog list.

13. Perform the input routine for the Dog and Cat information as specified in Exercise 6. In addition to creating a main list, create separate cat and dog lists (see Exercise 12). After the lists are created, allow the end user to add or remove information. Display the following menu choices:
  1. Add Cat
  2. Add Dog
  3. Remove Cat
  4. Remove Dog
  0. Quit

Allow the user to remove the information by specifying the name (assume there are no duplicate names). When adding a new cat or a dog, input the corresponding data values. Make sure to update the lists accordingly when adding or removing a pet. Repeat the operation until the user wants to quit. Notice that we use 0 for the menu choice Quit. By doing this way we don't have to change the code for quitting the program when we add more menu choices later.

### Development Exercises

For the following exercises, use the incremental development methodology to implement the program. For each exercise, identify the program tasks, create a design document with class descriptions, and draw the program diagram. Map out the development steps at the start. Present any design alternatives and justify your selection. Be sure to perform adequate testing at the end of each development step.

14. Write a personal finance manager program that maintains information on your bank accounts. Incorporate these rules:
  - For the savings accounts, you can make a maximum of three withdrawals in a month without incurring a fee. The bank charges \$1.00 for every withdrawal after the third.
  - For the checking accounts, the bank charges \$0.50 for every check you write for the first 20 checks (i.e., withdrawals) in a month. After that, there will be no charge.

You should be able to open and save account information to a file. You should be able to list all transactions of a given account or of all accounts. Include appropriate menus to select the options supported by the program. Consider using the `Date` class to record the date of transactions. The `Date` class is from the `java.util` package. Please refer to a `java.util` reference manual for information on this class.

15. Extend the address book sample development from Chapter 10. Instead of managing a single type of `Person`, incorporate additional types of persons such as `PersonalFriend` and `BusinessAssociate`. Define these classes as a subclass of `Person`. Design carefully to decide whether the `Person` class will be an abstract class.
16. Consider an asset-tracking program that will track four types of assets: electronic appliances, automobiles, furniture, and compact disks. What classes would you design for the program? Would you define four unrelated classes or one superclass and four subclasses? If you design a superclass, will it be an abstract superclass?
17. Implement the asset-tracking program of Exercise 10. Allow the user to add, modify, and delete electronic appliances, automobiles, furniture, and compact disks. Allow the user to list the assets by category and search for an asset by its serial number.

18. Extend the asset-tracking program of Exercise 11 by adding an object I/O capability.
19. Write an application that reads daily temperatures for 12 months and allows the user to get statistics. Support at least three options: monthly average of a given month, yearly average, and lowest and highest temperatures of a given month. Use a text file to store temperatures. A line in the text file contains daily temperatures for one month. The first line in the text file contains temperatures for January; the second line, those for February; and so forth. Use `StringTokenizer` to parse a line into temperatures of type `float`. For a data structure, consider using either an array of `Month` or a two-dimensional array of `float`. `Month` is a class you define yourself.



# GUI and Event-Driven Programming

# 14

## O b j e c t i v e s

---

*After you have read and studied this chapter, you should be able to*

- Define a subclass of the **JFrame** class using inheritance.
- Write event-driven programs using Java's delegation-based event model.
- Arrange GUI objects on a window using layout managers and nested panels.
- Write GUI application programs using **JButton**, **JLabel**, **ImageIcon**, **TextField**, **TextArea**, **JCheckBox**, **JRadioButton**, **JComboBox**, **JList**, and **JSlider** objects from the **javax.swing** package.
- Write GUI application programs with menus using **menu** objects from the **javax.swing** package.
- Write GUI application programs that process mouse events.



## Introduction



# T

he sample programs we have written so far used standard classes such as `Scanner`, `PrintStream` (`System.out` is an instance of `PrintStream`), and others for handling user interface. These standard classes are convenient and adequate for a basic program that does not require any elaborate user interface. For example, when we need to input a single integer value, calling the `nextInt` method of `Scanner` once to read that input is appropriate and effective. However, when we need to input, say, 10 values for a `Student` object (e.g., name, age, address, phone number, GPA), then using the `Scanner` class can be problematic because there is no simple and elegant way to allow the user to reenter any one of the values after all 10 input values are entered. So, instead of using the standard console input, it is a much better user interface to employ a single customized window that allows the user to enter all 10 values. We will learn how to build such a customized user interface in this chapter. As a part of building of a customized user interface, we will also learn how to detect mouse movements and clicking of mouse buttons.

### Hints, & Tips, Pitfalls



When we write a program for our own use, then we may choose to use the standard console input to enter 10 values. When we write a program for others, however, an effective user interface becomes of paramount importance. Next to the program correctness, the user interface of a program is often the most important criterion for the users to select one program over another, so it is critical for the success of the program to include the user interface that is logical, easy to use, and visually appealing.

### graphical user interface

The type of user interface we cover in this chapter is called a **graphical user interface** (GUI). In contrast, the user interface that uses `System.in` and `System.out` exclusively is called the *non-GUI*, or *console user interface*. In Java, GUI-based programs are implemented by using the classes from the standard `javax.swing` and `java.awt` packages. We will refer to them collectively as *GUI classes*. When we need to differentiate them, we will refer to the classes from `javax.swing` as **Swing classes** and those from `java.awt` as **AWT classes**. Some of the GUI objects from the `javax.swing` package are shown in Figure 14.1.

### Swing and AWT classes

In the older versions of Java (before Java 2 SDK 1.2), we had only AWT classes to build GUI-based programs. Many of the AWT classes are now superseded by their counterpart Swing classes (e.g., AWT `Button` class is superseded by Swing `JButton` class). AWT classes are still available, but it is generally preferable to use Swing classes. There are two main advantages in using the Swing classes over the AWT classes.

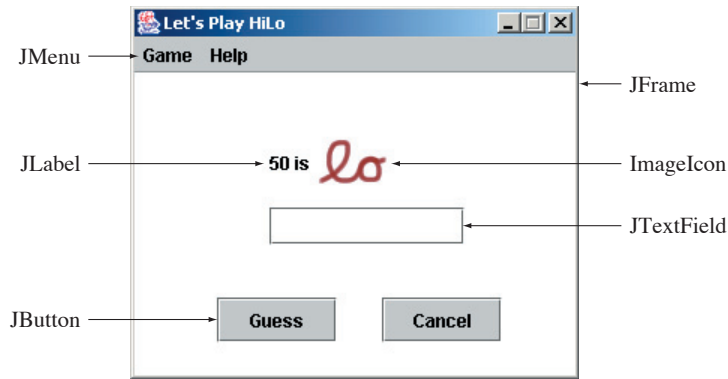

**Figure 14.1** Various GUI objects from the `javax.swing` package.

First, the Swing classes provide greater compatibility across different operating systems. The Swing classes are implemented fully in Java, and they behave the same on different operating systems. The AWT classes, on the other hand, are implemented by using the native GUI objects. For example, an AWT `Button` is implemented by using the Windows button object for the Windows operating system, the Macintosh button object for the Mac operating system, and so forth. Because the behaviors of underlying platform-specific GUI objects are not necessarily identical, an application that uses AWT classes may not behave the same on the different operating systems. To characterize the difference in implementation, the Swing classes are called *lightweight classes* and the AWT classes *heavyweight classes*.

Second, the Swing classes support many new functionalities not supported by the AWT counterparts. For example, we can easily display an image inside a button in addition to a text by using a Swing `JButton`, but only text can be displayed inside a button with an AWT `Button`.

We discuss the Swing classes exclusively. We use the AWT classes only when there are no counterpart Swing classes. One thing we must be careful of in using them is not to mix the counterparts in the same program because of their differences in implementation. For example, we should not mix Swing buttons and AWT buttons or Swing menus and AWT menus. If an AWT class has no counterpart Swing class, for example, the AWT `Graphics` class, then using it with other Swing classes poses no problem.

### Things to Remember



The Swing classes are called *lightweight classes* and the AWT classes *heavyweight classes*. As a general rule, because they are implemented differently, it is best not to mix the counterparts (e.g., Swing `JButton` and AWT `Button`) in the same program.

## You Might Want to Know



Many AWT classes are superseded by the Swing counterpart classes, but they are still available in the newer versions of Java SDK. Why? For example, if the Swing **JButton** class is a better version of the AWT **Button** class, then why don't we get rid of the **Button** class? The first reason is the backward compatibility, which means programs written for older Java SDKs will continue to run under newer SDKs. Had a newer Java SDK dropped the superseded AWT classes, then old programs that use those AWT classes would not run under the newer version of Java. The second reason is the availability of compatible Java interpreters. When you write a program using Swing classes, then the users of your program must have a compatible Java interpreter installed on their machines. If your users employ a Java interpreter that recognizes only AWT classes, then you have no option but to write the program using only the AWT classes.

### event-driven programming

To build an effective graphical user interface using objects from the `javax.swing` and `java.awt` packages, we must learn a new style of program control called *event-driven programming*. An *event* occurs when the user interacts with a GUI object. For example, when you move the cursor, click on a button, or select a menu choice, an event occurs. In event-driven programs, we program objects to respond to these events by defining event-handling methods. In this chapter we will learn the fundamentals of event-driven programming.

Since the main objective for this chapter is to teach the fundamentals of GUI and event-driven programming and not to provide an exhaustive coverage of the Swing classes, we will cover only the most common GUI objects.

## 14.1 | Simple GUI I/O with JOptionPane

One of the easiest ways to provide a simple GUI-based input and output is by using the `JOptionPane` class. For example, when we execute the statement

```
JOptionPane.showMessageDialog(null, "I Love Java");
```

the dialog shown in Figure 14.2 appears on the center of the screen.

In a GUI environment, there are basically two types of windows: a *general-purpose frame* and a *special-purpose dialog*. In Java, we use a `JFrame` object for a frame window and a `JDialog` object for a dialog. The first argument to the `showMessageDialog` method is a frame object that controls this dialog, and the second argument is the text to display. In the example statement, we pass `null`, a reserved word, meaning there is no frame object. If we pass `null` as the first argument, the dialog appears on the center of the screen. If we pass a frame object, then

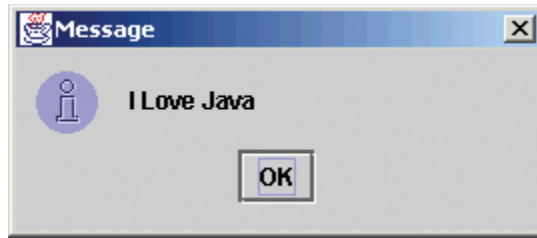

**Figure 14.2** A simple “message” dialog created by the `showMessageDialog` method by using the `JOptionPane` class.

the dialog is positioned at the center of the frame. Run the `Ch14ShowMessageDialog` class and confirm this behavior.

### Ch14ShowMessageDialog

```

/*
 Chapter 14 Sample Program: Shows a Message Dialog
 File: Ch14ShowMessageDialog.java
*/
import javax.swing.*;

class Ch14ShowMessageDialog {
 public static void main(String[] args) {
 JFrame jFrame;

 jFrame = new JFrame();
 jFrame.setSize(400,300);
 jFrame.setVisible(true);

 JOptionPane.showMessageDialog(jFrame, "How are you?");
 JOptionPane.showMessageDialog(null, "Good Bye");
 }
}

```

Notice that we are not creating an instance of the `JDialog` class directly by ourselves. However, when we call the `showMessageDialog` method, the `JOptionPane` class is actually creating an instance of `JDialog` internally. Notice that `showMessageDialog` is a class method, and therefore we are not creating a `JOptionPane` object. If we need a more complex dialog, then we create an instance of `JDialog`. But for a

simple display of text, calling the `showMessageDialog` class method of `JOptionPane` would suffice.

If we want to display multiple lines of text, we can use a special character sequence `\n` to separate the lines, as in

```
JOptionPane.showMessageDialog(null, "one\ntwo\nthree");
```

which will result in a dialog shown in Figure 14.3.

We can also use the `JOptionPane` class for input by using its `showInputDialog` method. For example, when we execute

```
JOptionPane.showInputDialog(null, "Enter text:");
```

the dialog shown in Figure 14.4 appears on the screen. To assign the name input to an input string, we write

```
String input;
input = JOptionPane.showInputDialog(null, "Enter text:");
```

Unlike the `Scanner` class that supports different input methods for specific data types, that is, `nextInt` and `nextDouble`, the `JOptionPane` supports only a string

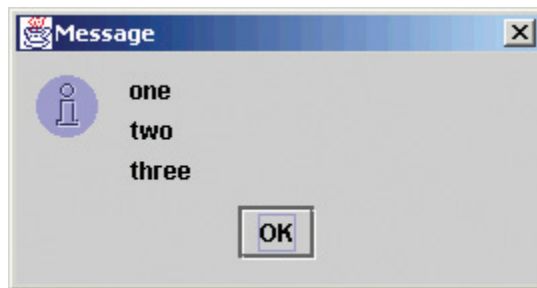

**Figure 14.3** A dialog with multiple lines of text.



**Figure 14.4** An input dialog that appears as a result of calling the `showInputDialog` class method of the `JOptionPane` class with “What is your name?” as the method’s second argument.

**Table 14.1** Common wrapper classes and their conversion methods.

Class	Method	Example
Integer	parseInt	Integer.parseInt("25") → 25 Integer.parseInt("25.3") → error
Long	parseLong	Long.parseLong("25") → 25L Long.parseLong("25.3") → error
Float	parseFloat	Float.parseFloat("25.3") → 25.3F Float.parseFloat("ab3") → error
Double	parseDouble	Double.parseDouble("25") → 25.0 Double.parseDouble("ab3") → error

input. To input a numerical value, we need to perform the string conversion ourselves. To input an integer value, say, age, we can write the code as follows:

```
String str
 = JOptionPane.showInputDialog(null, "Enter age:");

int age = Integer.parseInt(str);
```

If the user enters a string that cannot be converted to an int, for example, 12.34 or abc123, a `NumberFormatException` error will result. We use corresponding wrapper classes to convert the string input to other numerical data values.

Table 14.1 lists common wrapper classes and their corresponding conversion methods.



1. Display the message I Love Java by using `JOptionPane`.
2. Using `JOptionPane` input dialog, write a statement to input the person's first name.
3. Using `JOptionPane` input dialog, write a statement to input the person's age (integer).

## 14.2 Customizing Frame Windows

To create a customized user interface, we often define a subclass of the `JFrame` class. The helper class `MainWindow` we used in the Sample Development section of Chapter 13, for example, is a subclass of the `JFrame` class. The `JFrame` class contains the most rudimentary functionalities to support features found in any frame window, such as minimizing the window, moving the window, and resizing the window.

In writing practical programs, we normally do not create an instance of the `JFrame` class because a `JFrame` object is not capable of doing anything meaningful. For example, if we want to use a frame window for a word processor, we need a frame window capable of allowing the user to enter, cut, and paste text; change font; print text; and so forth. To design such a frame window, we would define a subclass of the `JFrame` class and add methods and data members to implement the needed functionalities.

Before we show sample subclasses of `JFrame`, let's first look at the following program which displays a default `JFrame` object on the screen:

```

/*
Chapter 14 Sample Program: Displays a default JFrame window
File: Ch14DefaultJFrame.java
*/
import javax.swing.*;

class Ch14DefaultJFrame {
 public static void main(String[] args) {
 JFrame defaultJFrame;

 defaultJFrame = new JFrame();

 defaultJFrame.setVisible(true);
 }
}

```

When this program is executed, a default `JFrame` object, shown in Figure 14.5, appears on the screen. Since no methods (other than `setVisible`) to set the properties of the `JFrame` object (such as its title, location, and size) are called, a very small default `JFrame` object appears at the top left corner of the screen.



You may not notice this frame window on the screen at first because it is so small. Look carefully at the top left corner of the screen.

**Figure 14.5** A default `JFrame` window appears at the top left corner of the screen.

## extends

Now let's define a subclass of the `JFrame` class and add some default characteristics. To define a subclass of another class, we declare the subclass with the reserved word `extends`. So, to define a class named `Ch14JFrameSubclass1` as a subclass of `JFrame`, we declare the subclass as

```
class Ch14JFrameSubclass1 extends JFrame {
 ...
}
```

For the `Ch14JFrameSubclass1` class, we will add the following default characteristics:

- The title is set to `My First Subclass`.
- The program terminates when the Close box is clicked.<sup>1</sup>
- The size of the frame is set to 300 pixels wide and 200 pixels high.
- The frame is positioned at screen coordinate (150, 250).

The effect of these properties is illustrated in Figure 14.6.

All these properties are set inside the default constructor. To set the frame's title, we pass the title to the `setTitle` method. To set the frame's size, we pass its width and height to the `setSize` method. To position the frame's top left corner to the coordinate  $(x, y)$ , we pass the values  $x$  and  $y$  to the `setLocation` method. Finally, to terminate

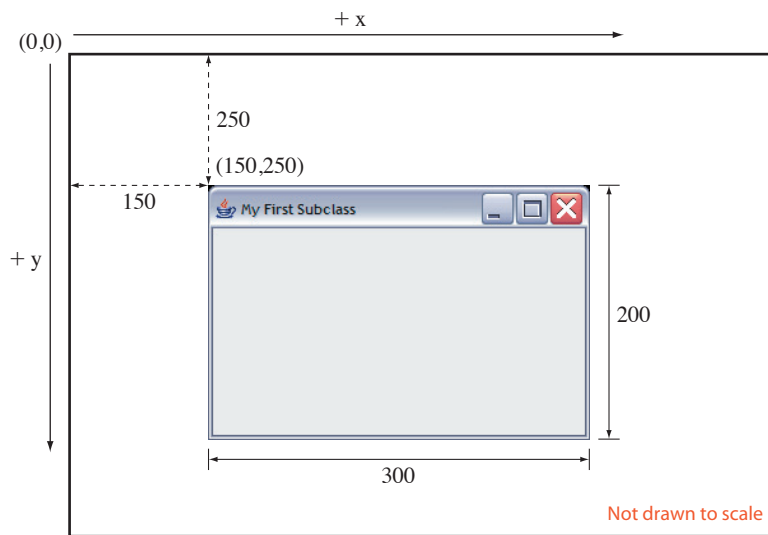

**Figure 14.6** How an instance of `Ch14JFrameSubclass1` will appear on the screen.

<sup>1</sup>If we don't add this functionality, the window will close, but the program does not terminate. In a normal environment, we can still terminate the program by closing the command window, the one with the black background on the Windows platform.



the program when the frame is closed, we call the `setDefaultCloseOperation` with the class constant `EXIT_ON_CLOSE` as an argument. The `Ch14JFrameSubclass1` class is declared as follows:

```

/*
Chapter 14 Sample Program: A simple subclass of JFrame

File: Ch14JFrameSubclass1.java
*/

import javax.swing.*;

class Ch14JFrameSubclass1 extends JFrame {

 private static final int FRAME_WIDTH = 300;
 private static final int FRAME_HEIGHT = 200;
 private static final int FRAME_X_ORIGIN = 150;
 private static final int FRAME_Y_ORIGIN = 250;

 public Ch14JFrameSubclass1 () {

 //set the frame default properties
 setTitle ("My First Subclass");
 setSize (FRAME_WIDTH, FRAME_HEIGHT);
 setLocation (FRAME_X_ORIGIN, FRAME_Y_ORIGIN);

 //register 'Exit upon closing' as a default close operation
 setDefaultCloseOperation(EXIT_ON_CLOSE);

 }
}

```

Calls the inherited methods.

Notice the methods such as `setTitle`, `setSize`, and others are all defined in the `JFrame` and its ancestor classes (ancestors are the superclasses in the inheritance hierarchy). Every method of a superclass is inherited by its subclass. Because the subclass-superclass relationships are formed into an inheritance hierarchy, a subclass inherits all methods defined in its ancestor classes. And we can call an inherited method from the method of a subclass in the manner identical to calling a method defined in the subclass, that is, without using dot notation or by using dot notation with the reserved word `this`.

### Things to Remember



*Inherited methods are called from the method of a subclass without using dot notation or by using dot notation with the reserved word **this**.*

Here's the main class to test the Ch14JFrameSubclass1 class:

```
/*
 Chapter 14 Sample Program: Displays a default Ch14JFrameSubclass window
 File: Ch14TestJFrameSubclass.java
*/
class Ch14TestJFrameSubclass {
 public static void main(String[] args) {
 Ch14JFrameSubclass1 myFrame;
 myFrame = new Ch14JFrameSubclass1();
 myFrame.setVisible(true);
 }
}
```

When it is executed, an instance of Ch14JFrameSubclass1 appears on the screen, as illustrated in Figure 14.6. Notice this main class is identical to Ch14DefaultJFrame except for the creation of a Ch14JFrameSubclass1 instance instead of a JFrame instance. Also notice that there's no need to import the javax.swing package because the main class does not make any direct reference to the classes in this package.

Since we did not set the background color for Ch14JFrameSubclass1, the default white was used as the frame's background color. (*Note:* If you see a different background color, such as gray, then most likely you are using an older version of Java, SDK 1.4 or earlier.) Let's define another subclass named Ch14JFrameSubclass2 that has a blue background color instead. We will define this class as an instantiable main class so we don't have to define a separate main class. To make the background appear in blue, we need to access the content pane of a frame. A frame's *content pane* designates the area of the frame that excludes the title and menu bars and the border. It is the area we can use to display the content (text, image, etc.). We access the content pane of a frame by calling the frame's `getContentPane` method. And to change the background color to blue, we call the content pane's `setBackground` method. We carry out these operations in the private `changeBkColor` method of Ch14JFrameSubclass2. Here's the class definition:

content pane

```
/*
 Chapter 14 Sample Program: A simple subclass of JFrame
 that changes the background
 color to blue.
*/
```

```

File: Ch14JFrameSubclass2.java
*/

import javax.swing.*;
import java.awt.*;

class Ch14JFrameSubclass2 extends JFrame {

 private static final int FRAME_WIDTH = 300;
 private static final int FRAME_HEIGHT = 200;
 private static final int FRAME_X_ORIGIN = 150;
 private static final int FRAME_Y_ORIGIN = 250;

 public static void main(String[] args) {
 Ch14JFrameSubclass2 frame = new Ch14JFrameSubclass2();
 frame.setVisible(true);
 }

 public Ch14JFrameSubclass2() {

 //set the frame default properties
 setTitle ("Blue Background JFrame Subclass");
 setSize (FRAME_WIDTH, FRAME_HEIGHT);
 setLocation (FRAME_X_ORIGIN, FRAME_Y_ORIGIN);

 //register 'Exit upon closing' as a default close operation
 setDefaultCloseOperation(EXIT_ON_CLOSE);

 changeBkColor();
 }

 private void changeBkColor() {
 Container contentPane = getContentPane();
 contentPane.setBackground(Color.BLUE);
 }
}

```

Running the program will result in the frame shown in Figure 14.7 appearing on the screen. Notice that we declare the variable `contentPane` in the `changeBkColor` method as `Container`. We do *not* have a class named `ContentPane`. By declaring the variable `contentPane` as `Container`, we can make it refer to any instance of the `Container` class or the descendant classes of `Container`. This makes our code more general because we are not tying the variable `contentPane` to any one specific class. By default, the `getContentPane` method of `JFrame` in fact returns the descendant class of `Container` called `JPanel`. We will describe the `JPanel` class in Section 14.5.

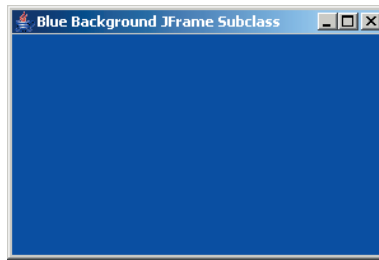

**Figure 14.7** An instance of `Ch14JFrameSubclass2` that has blue background.

### 14.3 GUI Programming Basics

In this section, we will develop a sample frame window that illustrates the fundamentals of GUI programming. The sample frame window has two buttons labeled CANCEL and OK. When you click the CANCEL button, the window's title is changed to You clicked CANCEL. Likewise, when you click the OK button, the window's title is changed to You clicked OK. Figure 14.8 shows the window when it is first opened and after the CANCEL button is clicked.

There are two key aspects involved in GUI programming. One is the placement of GUI objects on the content pane of a frame, and the other is the handling of events generated by these GUI objects. We will develop the sample program in two steps. First we will define a JFrame subclass called `Ch14JButtonFrame` to show how the two buttons labeled OK and CANCEL are placed on the frame. Then we will implement another subclass called `Ch14JButtonEvents` to show how the button events are processed to change the frame's title.

#### Button Placement

pushbutton

The type of button we use here is called a *pushbutton*. Since we discuss the pushbuttons only in this chapter, we will simply call them buttons. To use a button in a program, we create an instance of the `javax.swing.JButton` class. We will create two

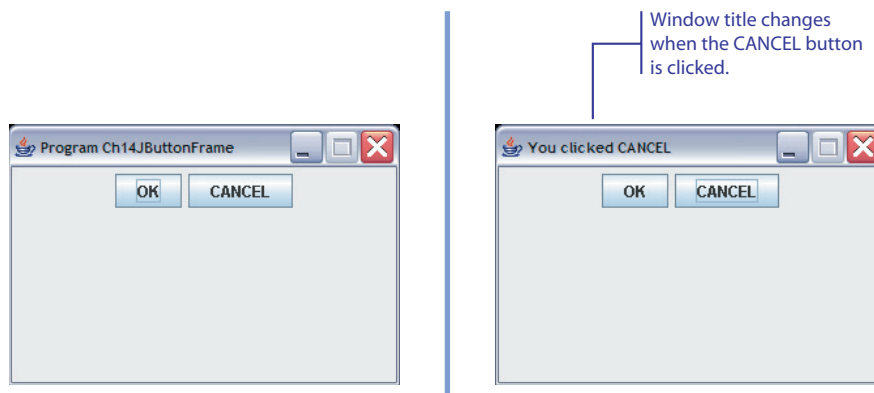

**Figure 14.8** A sample window when it is first opened and after the **CANCEL** button is clicked.

buttons and place them on the frame's content pane in the constructor. Let's name the two buttons `cancelButton` and `okButton`. We declare and create these buttons in the following manner:

```
import javax.swing.*;
...
JButton cancelButton, okButton;

cancelButton = new JButton("CANCEL");
okButton = new JButton("OK");
```

The text we pass to the constructor is the label of a button. After the buttons are created, we must place them on the frame's content pane.

There are two general approaches to placing buttons (and other types of GUI objects) on a frame's content pane, one that uses a layout manager and another that does not. The *layout manager* for a container is an object that controls the placement of the GUI objects. For example, the simplest layout manager called `FlowLayout` places GUI objects in the top-to-bottom, left-to-right order. If we do not use any layout manager, then we place GUI objects by explicitly specifying their position and size on the content pane. We call this approach *absolute positioning*. In this section, we will use `FlowLayout`. We will discuss other common layout managers and absolute positioning in Section 14.4.

To use the flow layout, we set the layout manager of a frame's content pane by passing an instance of `FlowLayout` to the `setLayout` method:

```
contentPane.setLayout(new FlowLayout());
```

After the layout manager is set, we add the two buttons to the content pane, so they become visible when the frame is displayed on the screen:

```
contentPane.add(okButton);
contentPane.add(cancelButton);
```

Notice that the sizes of the OK and CANCEL buttons are different. The default size of a button depends on the number of characters in the button's label. We can override the default by calling the `setSize` method. For example, we can set their width to 80 pixels and height to 30 pixels by writing

```
okButton.setSize(80, 30);
cancelButton.setSize(80, 30);
```

However, the `setSize` method does not take effect when the layout manager is used. It only works with absolute positioning. We won't be using the `setSize` method here.

We are now ready for the complete listing of the `Ch14JButtonFrame` class:

```
/*
Chapter 14 Sample Program: Displays a frame with two buttons
File: Ch14JButtonFrame.java
*/
```

```
import javax.swing.*;
import java.awt.*;

class Ch14JButtonFrame extends JFrame {

 private static final int FRAME_WIDTH = 300;
 private static final int FRAME_HEIGHT = 200;
 private static final int FRAME_X_ORIGIN = 150;
 private static final int FRAME_Y_ORIGIN = 250;

 private JButton cancelButton;
 private JButton okButton;

 public static void main(String[] args) {
 Ch14JButtonFrame frame = new Ch14JButtonFrame();
 frame.setVisible(true);
 }

 public Ch14JButtonFrame() {

 Container contentPane = getContentPane();

 //set the frame properties
 setSize (FRAME_WIDTH, FRAME_HEIGHT);
 setResizable(false);
 setTitle ("Program Ch14JButtonFrame");
 setLocation (FRAME_X_ORIGIN, FRAME_Y_ORIGIN);

 //set the layout manager
 contentPane.setLayout(new FlowLayout());

 //create and place two buttons on the frame's content pane
 okButton = new JButton("OK");
 contentPane.add(okButton);

 cancelButton = new JButton("CANCEL");
 contentPane.add(cancelButton);

 //register 'Exit upon closing' as a default close operation
 setDefaultCloseOperation(EXIT_ON_CLOSE);
 }
}
```

When we run the program, we see two buttons appear on the frame. We can click the buttons, but nothing happens, of course, because the code to handle the button clicks is not yet added to the class. We'll add the required code next.

## Handling Button Events

Now let's study how we process the button clicks. An action such as clicking a button is called an *event*, and the mechanism to process the events *event handling*. The event-handling model of Java is based on the concept known as the *delegation based event model*. With this model, event handling is implemented by two types of objects: event source objects and event listener objects.

A GUI object, such as a button, where the event occurs is called an *event*, or simply, the *event source*. We say an event source *generates* events. So, for example, when the user clicks on a button, the corresponding JButton object will generate an action event. When an event is generated, the system notifies the relevant event listener objects. An *event listener object*, or simply an *event listener*, is an object that includes a method that gets executed in response to generated events. It is possible for a single object to be both an event source and an event listener.

Among the many different types of events, the most common one is called an *action event*. For example, when a button is clicked or a menu item is selected, an event source will generate an action event. For the generated events to be processed, we must associate, or register, event listeners to the event sources. If the event sources have no registered listeners, then generated events are simply ignored (this is what happened in the Ch14JButtonFrame program). For each type of event, we have a corresponding listener. For example, we have action listeners for action events, window listeners for window events, mouse listeners for mouse events, and so forth. Event types other than action events are discussed later in this chapter. If we wish to process the action events generated by a button, then we must associate an action listener to the button.

An object that can be registered as an action listener must be an instance of a class that is declared specifically for the purpose. We call such class an *action listener class*. For this sample program, let's name the action listener class ButtonHandler. We will describe how to define the ButtonHandler class shortly. But first we will show the step to register an instance of ButtonHandler as the action listener of the two action event sources—okButton and cancelButton—of the sample frame window.

An action listener is associated to an action event source by calling the event source's addActionListener method with this action listener as its argument. For example, to register an instance of ButtonHandler as an action listener of okButton and cancelButton, we can execute the following code:

```
ButtonHandler handler = new ButtonHandler();
 okButton.addActionListener(handler);
 cancelButton.addActionListener(handler);
```

Notice that we are associating a single ButtonHandler object as an action listener of both buttons, because, although we can, it is not necessary to associate two separate listeners, one for the OK button and another for the CANCEL button. A single listener can be associated to multiple event sources. Likewise, although not frequently used, multiple listeners can be associated to a single event source.

event

delegation-based event model

event source

event listener

action event

## Things to Remember



*A single listener can be associated to multiple event sources, and multiple listeners can be associated to a single event source.*

When an event source generates an event, the system checks for matching registered listeners (e.g., for action events the system looks for registered action listeners, for window events the system looks for registered window listeners, and so forth). If there is no matching listener, the event is ignored. If there is a matching listener, the system notifies the listener by calling the listener's corresponding method. In case of action events, this method is `actionPerformed`. To ensure that the programmer includes the necessary `actionPerformed` method in the action listener class, the class must implement the `ActionListener` interface. The `ButtonHandler` class, for example, must be defined in the following way:

```
import java.awt.event.*;
class ButtonHandler implements ActionListener {
 ...
}
```

*ActionListener is defined in this package.*

Remember that, unlike a class, a Java interface includes only constants and abstract methods. The `java.awt.event.ActionListener`, for instance, is defined as

```
interface ActionListener {
 public void actionPerformed(ActionEvent evt);
}
```

*There's no method body, only the method header.*

The `ButtonHandler` class is defined as follows:

```
class ButtonHandler implements ActionListener {
 //data members and constructors come here
 public void actionPerformed(ActionEvent evt) {
 //event-handling statements come here
 }
}
```

An argument to the `actionPerformed` method is an `ActionEvent` object that represents an action event, and the `ActionEvent` class includes methods to access the properties of a generated event.

We want to change the title of a frame to `You clicked OK` or `You clicked CANCEL` depending on which button is clicked. This is done inside the `actionPerformed`



method. The general idea of the method is as follows:

```
public void actionPerformed(ActionEvent evt) {
 String buttonText
 = get the text of the event source;

 JFrame frame
 = the frame that contains this event source;

 frame.setTitle("You clicked " + buttonText);
}
```

The first statement retrieves the text of the event source (the text of the `okButton` is the string `OK` and the text of the `cancelButton` is the string `CANCEL`). We can do this in two ways. The first way is to use the `getActionCommand` method of the action event object `evt`. Using this method, we can retrieve the text of the clicked button as

```
String buttonText = evt.getActionCommand();
```

The second way is to use the `getSource` method of the action event object `evt`. Using this method, we can retrieve the text of the clicked button as

```
JButton clickedButton = (JButton) evt.getSource();
String buttonText = clickedButton.getText();
```



Notice the typecast to an appropriate class is necessary.

Notice the typecasting of an object returned by the `getSource` method to `JButton`. The object returned by the `getSource` method can be an instance of any class, so we need to typecast the returned object to a proper class in order to use the desired method.

Now, to find the frame that contains the event source, we proceed in two steps. First, we get the root pane to which this event source belongs. Second, we get the frame that contains this root pane. Here's the necessary sequence of statements to access the frame that contains the event source:

```
JRootPane rootPane = clickedButton.getRootPane();
Frame frame = (JFrame) rootPane.getParent();
```



Typecasting is necessary here, too.

A frame window contains nested layers of panes (the content pane in which we place GUI objects is one of them). The topmost pane is called the *root pane* (an instance of `JRootPane`). We can access the root pane of a frame by calling the GUI object's `getRootPane` method. From the root pane, we can access the frame object by calling the root pane's `getParent` method. Because a root pane can be contained by different types of containers (frames, dialogs, etc.), we need to typecast the returned object to `JFrame` in this example.

Here's the complete ButtonHandler class:

```
/*
 Chapter 14 Sample Program: Event listener for button click events
 File: ButtonHandler.java
*/
import javax.swing.*;
import java.awt.*;
import java.awt.event.*;

class ButtonHandler implements ActionListener {
 public ButtonHandler() {
 }

 public void actionPerformed(ActionEvent event) {
 JButton clickedButton = (JButton) event.getSource();
 JRootPane rootPane = clickedButton.getRootPane();
 Frame frame = (JFrame) rootPane.getParent();
 String buttonText = clickedButton.getText();
 frame.setTitle("You clicked " + buttonText);
 }
}
```

And here's the complete Ch14JButtonEvents class (notice that this class is essentially the same as the Ch14JButtonFrame class except for the portion that deals with the registration of a ButtonHandler to two event sources):

```
/*
 Chapter 14 Sample Program: Displays a frame with two buttons
 and associates an instance of
 ButtonHandler to the two buttons
 File: Ch14JButtonEvents.java
*/
import javax.swing.*;
import java.awt.*;

class Ch14JButtonEvents extends JFrame {
 private static final int FRAME_WIDTH = 300;
 private static final int FRAME_HEIGHT = 200;
```

```

private static final int FRAME_X_ORIGIN = 150;
private static final int FRAME_Y_ORIGIN = 250;

private JButton cancelButton;
private JButton okButton;

public static void main(String[] args) {
 Ch14JButtonEvents frame = new Ch14JButtonEvents();
 frame.setVisible(true);
}

public Ch14JButtonEvents() {

 Container contentPane = getContentPane();

 //set the frame properties
 setSize (FRAME_WIDTH, FRAME_HEIGHT);
 setResizable (false);
 setTitle ("Program Ch14JButtonFrame");
 setLocation (FRAME_X_ORIGIN, FRAME_Y_ORIGIN);

 //set the layout manager
 contentPane.setLayout(new FlowLayout());

 //create and place two buttons on the frame's content pane
 okButton = new JButton("OK");
 contentPane.add(okButton);

 cancelButton = new JButton("CANCEL");
 contentPane.add(cancelButton);

 //registering a ButtonHandler as an action listener of the
 //two buttons
 ButtonHandler handler = new ButtonHandler();
 cancelButton.addActionListener(handler);
 okButton.addActionListener(handler);

 //register 'Exit upon closing' as a default close operation
 setDefaultCloseOperation(EXIT_ON_CLOSE);
}
}

```

### Making a Frame the Event Listener

Instead of creating a separate event listener class such as `ButtonHandler`, it is actually more common to let a frame be the event listener of the GUI objects it contains. We stated earlier that any class can implement the `ActionListener` interface. We can declare a subclass of `JFrame` that implements the `ActionListener` interface. As an illustration of this technique, let's define a subclass of `JFrame` called `Ch14JButtonFrameHandler`. This class combines the functionalities of the `Ch14JButtonEvents` and `ButtonHandler` classes.

Here's the class:

```
/*
 Chapter 14 Sample Program: Displays a frame with two buttons
 and handles the button events

 File: Ch14JButtonFrameHandler.java
*/

import javax.swing.*;
import java.awt.*;
import java.awt.event.*;

class Ch14JButtonFrameHandler extends JFrame implements ActionListener {

 private static final int FRAME_WIDTH = 300;
 private static final int FRAME_HEIGHT = 200;
 private static final int FRAME_X_ORIGIN = 150;
 private static final int FRAME_Y_ORIGIN = 250;

 private JButton cancelButton;
 private JButton okButton;

 public static void main(String[] args) {
 Ch14JButtonFrameHandler frame = new Ch14JButtonFrameHandler();
 frame.setVisible(true);
 }

 public Ch14JButtonFrameHandler() {

 Container contentPane = getContentPane();

 //set the frame properties
 setSize (FRAME_WIDTH, FRAME_HEIGHT);
 setResizable(false);
 setTitle ("Program Ch14JButtonFrameHandler");
 setLocation (FRAME_X_ORIGIN, FRAME_Y_ORIGIN);

 //set the layout manager
 contentPane.setLayout(new FlowLayout());

 //create and place two buttons on the frame's content pane
 okButton = new JButton("OK");
 contentPane.add(okButton);

 cancelButton = new JButton("CANCEL");
 contentPane.add(cancelButton);

 //register this frame as an action listener of the two buttons
 cancelButton.addActionListener(this);
 okButton.addActionListener(this);
 }
}
```

```

//register 'Exit upon closing' as a default close operation
setDefaultCloseOperation(EXIT_ON_CLOSE);
}

public void actionPerformed(ActionEvent event) {
 JButton clickedButton = (JButton) event.getSource();

 String buttonText = clickedButton.getText();

 setTitle("You clicked " + buttonText);
}
}

```

Calls the `setTitle` method of this frame object.

Notice how we call the `addActionListener` method of `cancelButton` and `okButton`. This frame object is the action event listener, so we pass it as an argument to the method as

```

cancelButton.addActionListener(this);
okButton.addActionListener(this);

```

Likewise, because the `actionPerformed` method now belongs to this frame class itself, we can call other methods of the frame class from the `actionPerformed` method without dot notation. So the statement to change the title is simply

```

setTitle("You clicked " + buttonText);

```



1. What is the purpose of a layout manager?
2. Which object generates events? Which object processes events?
3. A class that implements the `ActionListener` interface must implement which method?
4. What does the `getActionCommand` method of the `ActionEvent` class return?

## 14.4 | Text-Related GUI Components

In this section we will introduce three Swing GUI classes—`JLabel`, `JTextField`, and `JTextArea`—that deal with text. The first two deal with a single line of text and the last with multiple lines of text. A `TextField` object allows the user to enter a single line of text, while a `JLabel` object is for displaying uneditable text. A `JTextArea`

object allows the user to enter multiple lines of text. It can also be used for displaying multiple lines of uneditable text.

Like a `JButton` object, an instance of `JTextField` generates an action event. A `JTextField` object generates an action event when the user presses the Enter key while the object is active (it is active when you see the vertical blinking line in it). `JLabel`, on the other hand, does not generate any event. A `JTextArea` object also generates events, specifically the types of events called *text events* and *document events*. Handling of these events is more involved than handling action events, so to keep the discussion manageable, we won't be processing the `JTextArea` events.

We will describe the `JTextField` class first. We set a `JTextField` object's size and position and register its action listener in the same way as we did for the `JButton` class. To illustrate its use, we will modify the `Ch14JButtonFrameHandler` by adding a single `JTextField` object. We will call the new class `Ch14TextFrame1`. The effect of clicking the buttons `CANCEL` and `OK` is the same as before. If the user presses the Enter key while the `JTextField` object is active, then we will change the title to whatever text is entered in this `JTextField` object. In the data declaration part, we add

```
JTextField inputLine;
```

and in the constructor we create a `JTextField` object and register the frame as its action listener:

```
public Ch14TextFrame1 {
 ...
 inputLine = new JTextField();
 inputLine.setColumns(22);
 add(inputLine);

 inputLine.addActionListener(this);
 ...
}
```

Notice the use of `setColumns` method instead of `setSize` in the earlier examples. We do not use the `setSize` method to set the size of a text field. The number we pass to the `setColumns` method does not necessarily mean the number of characters visible on the text field because the default font may be a variable-pitch font. If we set the font to a fixed-pitch font as in

```
...
inputLine.setColumns(20);
inputLine.setFont(new Font("Courier", Font.PLAIN, 14));
```

then 20 characters will be visible. Also, notice that the `setColumns` method affects the number of characters visible by setting the size of the text field. It does not affect the number of characters we can enter in the text field. There is no fixed bound

on the number of characters we can enter. When we enter more than the visible number of characters, then the text will scroll to the left.

Now we need to modify the `actionPerformed` method to handle both the button click events and the Enter key events. We have three event sources (two buttons and one text field), so the first thing we must do in the `actionPerformed` method is to determine the source. We will use the **instanceof** operator to determine the class to which the event source belongs. Here's the general idea:

**instanceof**

```

if (event.getSource() instanceof JButton) {
 //event source is either cancelButton
 //or okButton
 ...
} else { //event source must be inputLine
 ...
}

```

We use the `getText` method of `JTextField` to retrieve the text that the user has entered. The complete method is written as

```

public void actionPerformed(ActionEvent event) {

 if (event.getSource() instanceof JButton) {
 JButton clickedButton = (JButton) event.getSource();

 String buttonText = clickedButton.getText();

 setTitle("You clicked " + buttonText);

 } else { //the event source is inputLine
 setTitle("You entered '" +
 inputLine.getText() + "'");
 }
}

```

Notice that we can—but did not—write the else part as

```

JTextField textField = (JTextField) event.getSource();
setTitle("You entered '" + textField.getText() + "'");

```

because we know that the event source is `inputLine` in the else part. So we wrote it more succinctly as

```

setTitle("You entered '" + inputLine.getText() + "'");

```

Another approach to event handling is to associate a `ButtonHandler` (defined in Section 14.3) to the two button event sources and a `TextHandler` (need to add this new class) to the text field event source. This approach is left as an exercise.

Here's the complete Ch14TextFrame1 class:

```
/*
 Chapter 14 Sample Program: Displays a frame with two buttons
 and one text field

 File: Ch14TextFrame1.java
*/

import javax.swing.*;
import java.awt.*;
import java.awt.event.*;

class Ch14TextFrame1 extends JFrame implements ActionListener {

 private static final int FRAME_WIDTH = 300;
 private static final int FRAME_HEIGHT = 200;
 private static final int FRAME_X_ORIGIN = 150;
 private static final int FRAME_Y_ORIGIN = 250;

 private JButton cancelButton;
 private JButton okButton;

 private JTextField inputLine;

 public static void main(String[] args) {
 Ch14TextFrame1 frame = new Ch14TextFrame1();
 frame.setVisible(true);
 }

 public Ch14TextFrame1() {
 Container contentPane;

 //set the frame properties
 setSize (FRAME_WIDTH, FRAME_HEIGHT);
 setResizable(false);
 setTitle ("Program Ch14SecondJFrame");
 setLocation (FRAME_X_ORIGIN, FRAME_Y_ORIGIN);

 contentPane = getContentPane();
 contentPane.setLayout(new FlowLayout());

 inputLine = new JTextField();
 inputLine.setColumns(22);
 contentPane.add(inputLine);

 inputLine.addActionListener(this);
 }
}
```

Adding the `inputLine` text field.



```

//create and place two buttons on the frame
okButton = new JButton ("OK");
contentPane.add(okButton);

cancelButton = new JButton ("CANCEL");
contentPane.add(cancelButton);

//register this frame as an action listener of the two buttons
cancelButton.addActionListener(this);
okButton.addActionListener(this);

//register 'Exit upon closing' as a default close operation
setDefaultCloseOperation(EXIT_ON_CLOSE);
}

public void actionPerformed(ActionEvent event) {

 if (event.getSource() instanceof JButton) {
 JButton clickedButton = (JButton) event.getSource();

 String buttonText = clickedButton.getText();

 setTitle("You clicked " + buttonText);

 } else { //the event source is inputLine
 setTitle("You entered '" + inputLine.getText() + "'");
 }
}
}

```

Now, let's add a JLabel object to the frame. In the Ch14TextFrame1 class, we have one text field without any indication of what this text field is for. A JLabel object is useful in displaying a label that explains the purpose of the text field. Let's modify the Ch14TextFrame1 class by placing the label Please enter your name above the inputLine text field. We will call the modified class Ch14TextFrame2. We add the data member declaration

```
private JLabel prompt;
```

and create the object and position it in the constructor as

```
public Ch14TextFrame2 {
 ...
 prompt = new JLabel();
 prompt.setText("Please enter your name");
}

```

```

 prompt.setSize(150, 25);
 contentPane.add(prompt);
 ...
 }

```

We can also set the text at the time of object creation as

```
prompt = new JLabel("Please enter your name");
```

### ImageIcon

The `JLabel` class is not limited to the display of text. We can also use it to display an image. To display an image, we pass an `ImageIcon` object when we create a `JLabel` object instead of a string. To create this `ImageIcon` object, we must specify the filename of an image. Notice that the program we are running, `Ch14TextFrame2`, and the image file are placed in the same directory. We can place the image file anywhere we want, but the way we write the code here requires the image file to be placed in the same directory. We keep it this way to keep the code simple. We add the data member declaration

```
private JLabel image;
```

and then create it in the constructor as

```

public Ch14TextFrame2 {
 ...
 image = new JLabel(new ImageIcon("cat.gif"));
 image.setSize(50, 50);
 contentPane.add(image);
 ...
}

```

Figure 14.9 shows the frame that appears on the screen when the program is executed. As the sample code shows, it is a simple matter to replace the image. All we have to do is to put the image we want in the right directory and refer to this image file correctly when creating a new `ImageIcon` object. When we use a different image, we have to be careful, however, to adjust the width and height values in the `setBounds` method so the values will be large enough to display the complete image.



**Figure 14.9** The `Ch14TextFrame2` window with one text `JLabel`, one image `JLabel`, one `JTextField`, and two `JButton` objects.

Here's the Ch14TextFrame2 class (only the portion that is different from Ch14TextFrame1 is listed here):

```

/*
 Chapter 14 Sample Program: Displays a frame with two buttons,
 one text field and two labels

 File: Ch14TextFrame2.java
*/

import javax.swing.*;
import java.awt.*;
import java.awt.event.*;

class Ch14TextFrame2 extends JFrame implements ActionListener {

 ...

 private JLabel prompt;
 private JLabel image;

 public static void main(String[] args) {
 Ch14TextFrame2 frame = new Ch14TextFrame2();
 frame.setVisible(true);
 }

 public Ch14TextFrame2() {
 ...

 image = new JLabel(new ImageIcon("cat.gif"));
 image.setSize(50, 50);
 contentPane.add(image);

 prompt = new JLabel();
 prompt.setText("Please enter your name");
 prompt.setSize(150, 25);
 contentPane.add(prompt);

 ...

 }

 ...
}

```

Now let's create the third example by using a JTextArea object. We will call the sample class Ch14TextFrame3. In this sample program, we will add two buttons labeled ADD and CLEAR, one text field, and one text area to a frame. When a text is

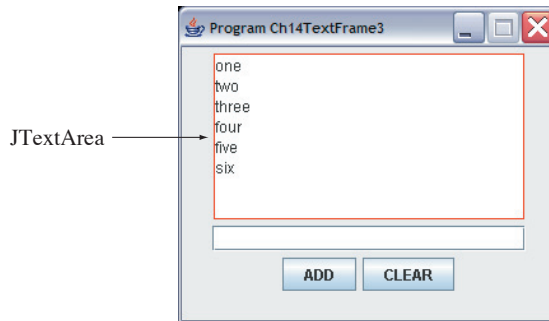

**Figure 14.10** The state of a **Ch14TextFrame3** window after six words are entered.

entered in the text field and the Enter (Return) key is pressed or the ADD button is clicked, the entered text is added to the list shown in the text area. Figure 14.10 shows the state of this frame after six words are entered.

We declare a `JTextArea` object `textArea` in the data member section as

```
private JTextArea textArea;
```

and add the statements to create it inside the constructor as

```
textArea = new JTextArea();
textArea.setColumns(22);
textArea.setRows(8);
textArea.setBorder(
 BorderFactory.createLineBorder(Color.RED));
textArea.setEditable(false);
contentPane.add(textArea);
```

By default, unlike the single-line `JTextField`, the rectangle that indicates the boundary of a `JTextArea` object is not displayed on the frame. We need to create the border for a `JTextArea` object explicitly. The easiest way to do so is to call one of the class methods of the `BorderFactory` class. In the example, we called the `createLineBorder` method with a `Color` object as its argument. We passed `Color.RED` so the red rectangle is displayed, as shown in Figure 14.10. The `createLineBorder` method returns a properly created `Border` object, and we pass this `Border` object to the `setBorder` method of the text area object. There are other interesting borders you might want to try. Table 14.2 lists other border types and the methods to create them. The API documentation of the `BorderFactory` class records more options and variations.

In the sample frame, we do not want the user to edit the text displayed in the text area, so we disable editing by the statement

```
textArea.setEditable(false);
```

**Table 14.2** Border-creating methods of the `javax.swing.BorderFactory` class. The listed methods are all class methods.

Some Class Methods of <code>javax.swing.BorderFactory</code>	
<b>public static</b>	<code>Border createEtchedBorder (java.awt.Color lineColor, java.awt.Color shadowColor)</code> Creates an etched border with <code>lineColor</code> as line color and <code>shadowColor</code> as shadow color.
<b>public static</b>	<code>Border createLoweredBevelBorder()</code> Creates a border with a lowered beveled edge with a bright shade of the GUI object's current background color for line and dark shading for shadow. This border is effective when you change the background color of the GUI object.
<b>public static</b>	<code>Border createRaisedBevelBorder()</code> Creates a border with a raised beveled edge with a bright shade of the GUI object's current background color for line and dark shading for shadow. This border is effective when you change the background color of the GUI object.
<b>public static</b>	<code>Border createTitledBorder(String title)</code> Creates a default (etched) border with <code>title</code> displayed at the left corner of the border.

To add a text to the text area, we use the `append` method. Notice that we cannot use the `setText` method of `JTextArea` here because it will replace the old content with the new text. What we want here is to add new text to the current content. Also, since we need to add new text on a separate line, we need to output the new-line control character `\n`. Here's the basic idea for adding new text to the text area object `textArea`:

```
String enteredText = inputLine.getText();
textArea.append(enteredText + "\n");
```

Because the actual sequence of characters to separate lines is dependent on the operating systems, if we want to maintain consistent behavior across all operating systems, it is best to not use a fixed character such as `\n`. Instead, we should call the `getProperty` method of the `System` class, passing the string `line.separator` as an argument, to get the actual sequence of characters used by the operating system on which the program is being executed. We can define a class constant as

```
private static final String NEWLINE
 = System.getProperty("line.separator");
```

and use it in the program as

```
textArea.append(enteredText + NEWLINE);
```

Here's the Ch14TextFrame3 class:

```
/*
 Chapter 14 Sample Program: Displays a frame with two buttons,
 one text field, and one text area
 File: Ch14TextFrame3.java
*/

import javax.swing.*;
import java.awt.*;
import java.awt.event.*;

class Ch14TextFrame3 extends JFrame implements ActionListener {

 private static final int FRAME_WIDTH = 300;
 private static final int FRAME_HEIGHT = 250;
 private static final int FRAME_X_ORIGIN = 150;
 private static final int FRAME_Y_ORIGIN = 250;

 private static final String EMPTY_STRING = "";
 private static final String NEWLINE
 = System.getProperty("line.separator");

 private JButton clearButton;
 private JButton addButton;
 private JTextField inputLine;
 private JTextArea textArea;

 public static void main(String[] args) {
 Ch14TextFrame3 frame = new Ch14TextFrame3();
 frame.setVisible(true);
 }

 public Ch14TextFrame3() {
 Container contentPane;

 //set the frame properties
 setSize (FRAME_WIDTH, FRAME_HEIGHT);
 setResizable(false);
 setTitle ("Program Ch14TextFrame3");
 setLocation (FRAME_X_ORIGIN, FRAME_Y_ORIGIN);

 contentPane = getContentPane();
 contentPane.setLayout(new FlowLayout ());

 textArea = new JTextArea();
 textArea.setColumns(22);
 textArea.setRows(8);
 textArea.setBorder(BorderFactory.createLineBorder(Color.RED));
 }
}
```

```

 textArea.setEditable(false);
 contentPane.add(textArea);

 inputLine = new JTextField();
 inputLine.setColumns(22);
 contentPane.add(inputLine);

 inputLine.addActionListener(this);

 //create and place two buttons on the frame
 addButton = new JButton ("ADD");
 contentPane.add(addButton);

 clearButton = new JButton ("CLEAR");
 contentPane.add(clearButton);

 //register this frame as an action listener of the two buttons
 clearButton.addActionListener(this);
 addButton.addActionListener(this);

 //register 'Exit upon closing' as a default close operation
 setDefaultCloseOperation(EXIT_ON_CLOSE);
 }

 public void actionPerformed(ActionEvent event) {

 if (event.getSource() instanceof JButton) {
 JButton clickedButton = (JButton) event.getSource();

 if (clickedButton == addButton) {
 addText(inputLine.getText());
 } else {
 clearText();
 }
 } else { //the event source is inputLine
 addText(inputLine.getText());
 }
 }

 private void addText(String newline) {
 textArea.append(newline + NEWLINE);
 inputLine.setText("");
 }

 private void clearText() {
 textArea.setText(EMPTY_STRING);
 inputLine.setText(EMPTY_STRING);
 }
}

```

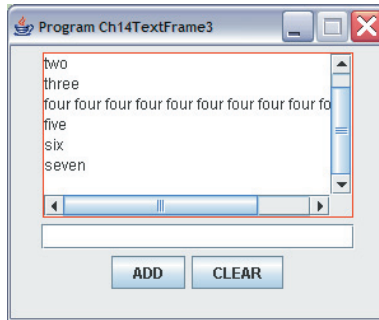

**Figure 14.11** A sample `Ch14TextFrame3` window when the `JScrollPane` GUI object is used.

### Using a `JScrollPane` to Add Scroll Bars Automatically

When we run the `Ch14TextFrame3` class and add more rows (lines) of text than the number of rows set by calling the `setRows` method, what happens? The height of the text area gets taller. Likewise, the text area expands horizontally when we enter a line longer than the specified width. This is not a desired behavior. The easiest way to handle the situation is to wrap the text area with an instance of `javax.swing.JScrollPane` that adds the vertical and horizontal scroll bars when necessary.

#### JScrollPane

In the original `Ch14TextFrame3` class, this is what we did to create and set the `JTextArea` object:

```
textArea = new JTextArea();
textArea.setColumns(22);
textArea.setRows(8);
textArea.setBorder(
 BorderFactory.createLineBorder(Color.RED));
textArea.setEditable(false);
contentPane.add(textArea);
```

To add scroll bars that will appear automatically when needed, we replace the last statement above with the following:

The scroll pane  
"wraps around"  
the text area.

```
JScrollPane scrollText= new JScrollPane(textArea);
scrollText.setSize(200, 135);
contentPane.add(scrollText);
```

Notice that the properties, such as the border and bounds, of the `JScrollPane` object are set, no longer the properties of the `JTextArea`. Figure 14.11 shows a sample `Ch14TextFrame3` object when the `JScrollPane` class is used.



1. What is the purpose of the `instanceof` operator?
2. What user action will result in a `JTextField` object generating an action event?
3. Does a `JLabel` object generate an event?
4. What is the difference between `textArea.setText("Hello")` and `textArea.append("Hello")`?



## 14.5 | Layout Managers

We showed only a very simplistic use of `FlowLayout` manager in Section 14.3. In this section, we will explain the use of layout managers in greater detail by discussing three commonly used layout managers. In addition, we will describe absolute positioning at the end of the section.

You  
Might  
Want to  
Know



A benefit of using a layout manager is the automatic adjustment of GUI objects when their container (frame, dialog, applet, etc.) is resized. For example, if we place a **JButton** at the center of the container by using some layout manager, then this **JButton** will still be positioned at the center when the size of the container is changed. This automatic adjustment is important also when we consider running our program on different platforms, because by using a layout manager effectively we will get a more consistent look to our frames and dialogs across different platforms. With absolute positioning, a frame that looks nice on one platform may not appear as nice on another platform.

### FlowLayout

The most basic layout is `java.awt.FlowLayout`. In using this layout, GUI components are placed in left-to-right order. When the component does not fit on the same line, left-to-right placement continues on the next line. As a default, components on each line are centered. When the frame containing the component is resized, the placement of components is adjusted accordingly. Figure 14.12 shows the placement of five buttons by using `FlowLayout`.

Before we add any components, first we assign the desired layout manager to the container, in this case the content pane of a frame, in the frame's constructor.

```
Container contentPane = getContentPane();
...
contentPane.setLayout(new FlowLayout());
```

A container has a default layout manager assigned to it, but it is always safer to explicitly assign the desired layout manager ourselves. After the layout manager is set, we create five buttons and add them to the content pane.

```
JButton button1, button2, button3, button4, button5;
...

button1 = new JButton("button1");
//do the same for other buttons

contentPane.add(button1);
contentPane.add(button2);
//and so forth
```

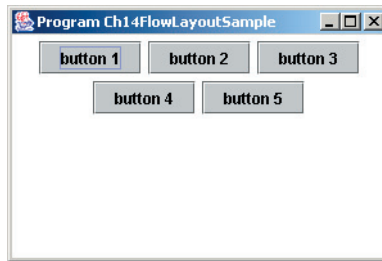

Center alignment is used as a default. It can be set to a different alignment at the time a `FlowLayout` is created.

When the frame first appears on the screen.

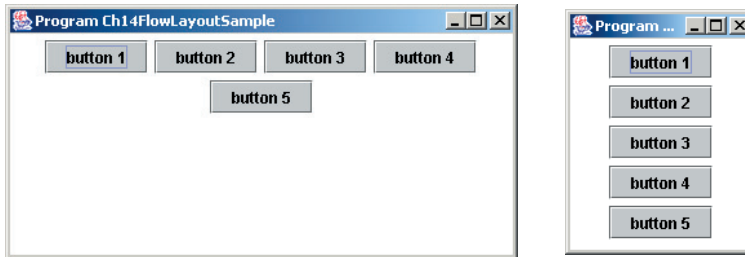

After the frame's width is widened and shortened.

**Figure 14.12** Placement of five buttons by using **FlowLayout** when the frame is first opened and after the frame is resized.

Notice the default is center alignment. We can change it to left or right alignment as

```
contentPane.setLayout(new FlowLayout(FlowLayout.LEFT));
```

or

```
contentPane.setLayout(new FlowLayout(FlowLayout.RIGHT));
```

Here's the complete sample code:

```
/*
Chapter 14 Sample Program: Illustrates the use of FlowLayout
File: Ch14FlowLayoutSample.java
*/

import javax.swing.*;
import java.awt.*;
```

```

class Ch14FlowLayoutSample extends JFrame {

 private static final int FRAME_WIDTH = 300;
 private static final int FRAME_HEIGHT = 200;
 private static final int FRAME_X_ORIGIN = 150;
 private static final int FRAME_Y_ORIGIN = 250;

 //-----
 // Main method
 //-----

 public static void main(String[] args) {
 Ch14FlowLayoutSample frame = new Ch14FlowLayoutSample();
 frame.setVisible(true);
 }

 public Ch14FlowLayoutSample() {
 Container contentPane;
 JButton button1, button2, button3, button4, button5;

 //set the frame properties
 setSize (FRAME_WIDTH, FRAME_HEIGHT);
 setTitle ("Program Ch14FlowLayoutSample");
 setLocation(FRAME_X_ORIGIN, FRAME_Y_ORIGIN);

 contentPane = getContentPane();
 contentPane.setBackground(Color.WHITE);
 contentPane.setLayout(new FlowLayout());

 //create and place four buttons on the content pane
 button1 = new JButton("button 1");
 button2 = new JButton("button 2");
 button3 = new JButton("button 3");
 button4 = new JButton("button 4");
 button5 = new JButton("button 5");

 contentPane.add(button1);
 contentPane.add(button2);
 contentPane.add(button3);
 contentPane.add(button4);
 contentPane.add(button5);

 //register 'Exit upon closing' as a default close operation
 setDefaultCloseOperation(EXIT_ON_CLOSE);
 }
}

```

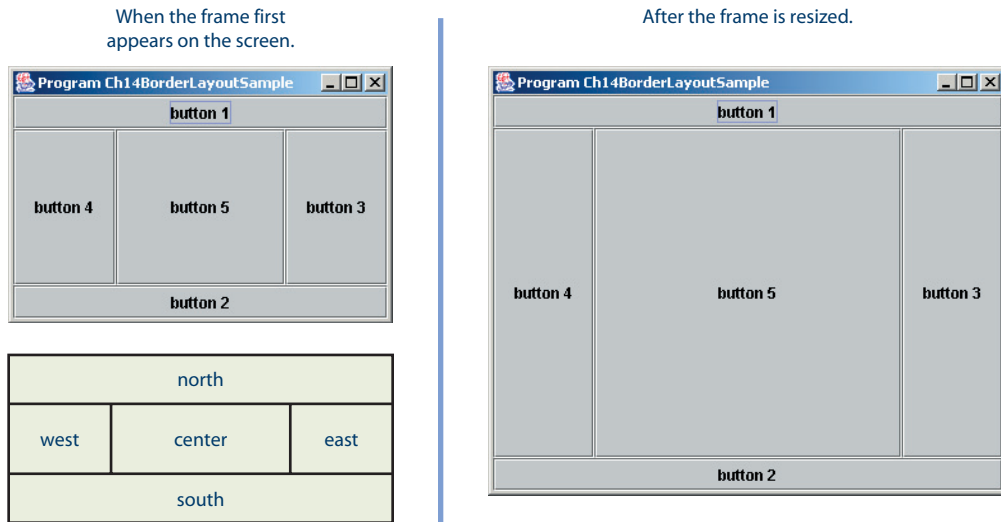

**Figure 14.13** Placement of five buttons by using **BorderLayout** when the frame is first opened and after the frame is resized.

### BorderLayout

The second layout manager is `java.awt.BorderLayout`. This layout manager divides the container into five regions: center, north, south, east, and west. Figure 14.13 shows five buttons placed in these five regions. The right frame in the figure is the state after it is resized. The north and south regions expand or shrink in height only, the east and west regions expand or shrink in width only, and the center region expands or shrinks on both height and width. Not all regions have to be occupied. Figure 14.14 shows the frame with only the center and east regions occupied with buttons.

We set the `BorderLayout` analogously as

```
contentPane.setLayout(new BorderLayout());
```

and then we place the GUI components, in this case, buttons, with the second argument specifying the region.

```
contentPane.add(button1, BorderLayout.NORTH);
contentPane.add(button2, BorderLayout.SOUTH);
contentPane.add(button3, BorderLayout.EAST);
contentPane.add(button4, BorderLayout.WEST);
contentPane.add(button5, BorderLayout.CENTER);
```

The `BorderLayout` used in Figures 14.13 and 14.14 has no gaps between the regions, which is the default. We can specify the amount of vertical and horizontal gaps between the regions in pixels. For example, to leave 10-pixel-wide gaps and 20-pixel-high gaps between the regions, we create a `BorderLayout` object by passing these values as arguments to the constructor.

```
contentPane.setLayout(new BorderLayout(10, 20));
```

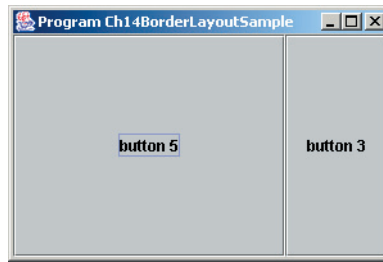

**Figure 14.14** Placement of two buttons by using **BorderLayout**. Buttons are placed on the center and east regions.

Here's the complete sample program:

```

/*
 Chapter 14 Sample Program: Illustrates the use of BorderLayout
 File: Ch14BorderLayoutSample.java
*/

import javax.swing.*;
import java.awt.*;

class Ch14BorderLayoutSample extends JFrame {

 private static final int FRAME_WIDTH = 300;
 private static final int FRAME_HEIGHT = 200;
 private static final int FRAME_X_ORIGIN = 150;
 private static final int FRAME_Y_ORIGIN = 250;

 //-----
 // Main method
 //-----
 public static void main(String[] args) {
 Ch14BorderLayoutSample frame = new Ch14BorderLayoutSample();
 frame.setVisible(true);
 }

 public Ch14BorderLayoutSample() {
 Container contentPane;
 JButton button1, button2, button3, button4, button5;

 //set the frame properties
 setSize (FRAME_WIDTH, FRAME_HEIGHT);
 setTitle ("Program Ch14BorderLayoutSample");
 setLocation(FRAME_X_ORIGIN, FRAME_Y_ORIGIN);
 }
}

```

```

contentPane = getContentPane();
contentPane.setBackground(Color.WHITE);
contentPane.setLayout(new BorderLayout());

//contentPane.setLayout(new BorderLayout(*hgap*/10, *vgap*/10));

//create and place four buttons on the content pane
button1 = new JButton("button 1");
button2 = new JButton("button 2");
button3 = new JButton("button 3");
button4 = new JButton("button 4");
button5 = new JButton("button 5");

contentPane.add(button1, BorderLayout.NORTH);
contentPane.add(button2, BorderLayout.SOUTH);
contentPane.add(button3, BorderLayout.EAST);
contentPane.add(button4, BorderLayout.WEST);
contentPane.add(button5, BorderLayout.CENTER);

//register 'Exit upon closing' as a default close operation
setDefaultCloseOperation(EXIT_ON_CLOSE);
}
}

```

### GridLayout

The third layout manager is [java.awt.GridLayout](#). This layout manager places GUI components on equal-size  $N \times M$  grids. Figure 14.15 shows five buttons placed on  $2 \times 3$  grids. Components are placed in top-to-bottom, left-to-right order. The frame on the right in Figure 14.15 is the state after it is resized. Notice the number of rows and columns remains the same, but the width and height of each region are changed.

To create a GridLayout object, we pass two arguments: number of rows and number of columns.

```
contentPane.setLayout(new GridLayout(2, 3));
```

We then place GUI components in the manner analogous to the one used for FlowLayout. If the value provided for the number of rows is nonzero, then the value we specify for the number of columns is actually irrelevant. The layout will create the designated number of rows and adjust the number of columns so that all components will fit in the designated number of rows. For example, placing the five buttons with any one of the following three statements will result in the same layout, namely, two rows of grids:

```

contentPane.setLayout(new GridLayout(2, 0));
contentPane.setLayout(new GridLayout(2, 1));
contentPane.setLayout(new GridLayout(2, 5));

```

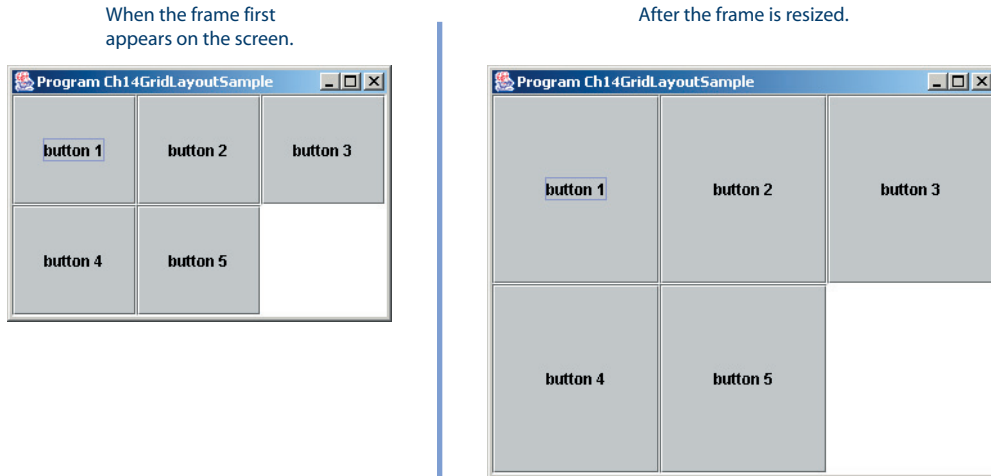

**Figure 14.15** Placement of five buttons by using **GridLayout** of two rows and three columns when the frame is first opened and after the frame is resized.

Here's the complete program listing for Ch14GridLayoutSample:

```

/*
 Chapter 14 Sample Program: Illustrates the use of GridLayout
 File: Ch14GridLayoutSample.java
*/

import javax.swing.*;
import java.awt.*;

class Ch14GridLayoutSample extends JFrame {

 private static final int FRAME_WIDTH = 300;
 private static final int FRAME_HEIGHT = 200;
 private static final int FRAME_X_ORIGIN = 150;
 private static final int FRAME_Y_ORIGIN = 250;

 //-----
 // Main method
 //-----
 public static void main(String[] args) {
 Ch14GridLayoutSample frame = new Ch14GridLayoutSample();
 frame.setVisible(true);
 }
}

```

```

public Ch14GridLayoutSample() {
 Container contentPane;
 JButton button1, button2, button3, button4, button5;

 //set the frame properties
 setSize (FRAME_WIDTH, FRAME_HEIGHT);
 setTitle ("Program Ch14GridLayoutSample");
 setLocation(FRAME_X_ORIGIN, FRAME_Y_ORIGIN);

 contentPane = getContentPane();
 contentPane.setBackground(Color.WHITE);
 contentPane.setLayout(new GridLayout(2,3));

 //create and place four buttons on the content pane
 button1 = new JButton("button 1");
 button2 = new JButton("button 2");
 button3 = new JButton("button 3");
 button4 = new JButton("button 4");
 button5 = new JButton("button 5");

 contentPane.add(button1);
 contentPane.add(button2);
 contentPane.add(button3);
 contentPane.add(button4);
 contentPane.add(button5);

 //register 'Exit upon closing' as a default close operation
 setDefaultCloseOperation(EXIT_ON_CLOSE);
}
}

```

absolute  
positioning

It is possible not to use any layout manager. If we do not use one, then we place GUI objects on the frame's content pane by explicitly specifying their position and size. We call this approach *absolute positioning*. Although layout managers are very useful in practical applications, knowing various layout managers is not indispensable for learning object-oriented and event-driven programming. So using absolute positioning is acceptable while learning object-oriented and event-driven programming. Keep in mind, however, that to build practical GUI-based Java programs, we must learn how to use layout managers effectively.

To use absolute positioning, we set the layout manager of a frame's content pane to none by passing null to the `setLayout` method:

```
contentPane.setLayout(null);
```

After the layout manager is set to null, we place two buttons at the position and in the size we want by calling the button's `setBounds` method as in

```
okButton.setBounds(75, 125, 80, 30);
```



```

Container contentPane = getContentPane();
JButton okButton = new JButton("OK");

contentPane.setLayout(null);
okButton.setBounds(70, 125, 80, 30);

contentPane.add(okButton);

```

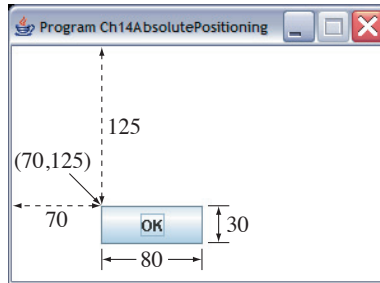

**Figure 14.16** This diagram illustrates the process of creating a button and placing it on a frame.

where the first two arguments specify the position of the button and the last two arguments specify the width and height of the button. Finally, to make a button appear on the frame, we need to add it to the content pane by calling the add method. For example, to add `okButton`, we call

```
contentPane.add(okButton);
```

Figure 14.16 illustrates the process.

Here's the program listing for `Ch14AbsolutePositioning`:

```

/*
Chapter 14 Sample Program: Shows how the absolute position works
File: Ch14AbsolutePositioning.java
*/

import javax.swing.*;
import java.awt.*;

class Ch14AbsolutePositioning extends JFrame {

 private static final int FRAME_WIDTH = 300;
 private static final int FRAME_HEIGHT = 220;
 private static final int FRAME_X_ORIGIN = 150;
 private static final int FRAME_Y_ORIGIN = 250;

```

```

private static final int BUTTON_WIDTH = 80;
private static final int BUTTON_HEIGHT = 30;

private JButton cancelButton;
private JButton okButton;

//-----
// Main method
//-----
public static void main(String[] args) {
 Ch14AbsolutePositioning frame = new Ch14AbsolutePositioning();
 frame.setVisible(true);
}

public Ch14AbsolutePositioning() {

 Container contentPane = getContentPane();

 //set the frame properties
 setSize (FRAME_WIDTH, FRAME_HEIGHT);
 setResizable(false);
 setTitle ("Program Ch14AbsolutePositioning");
 setLocation (FRAME_X_ORIGIN, FRAME_Y_ORIGIN);

 //set the content pane properties
 contentPane.setLayout(null);
 contentPane.setBackground(Color.WHITE);

 //create and place two buttons on the frame's content pane
 okButton = new JButton("OK");
 okButton.setBounds(70, 125, BUTTON_WIDTH, BUTTON_HEIGHT);
 contentPane.add(okButton);

 cancelButton = new JButton("CANCEL");
 cancelButton.setBounds(160, 125, BUTTON_WIDTH, BUTTON_HEIGHT);
 contentPane.add(cancelButton);

 //register 'Exit upon closing' as a default close operation
 setDefaultCloseOperation(EXIT_ON_CLOSE);
}
}

```



1. How does the flow layout place the components?
2. Which layout manager divides the container into grids of equal size?
3. Write a statement to create a border layout with 20-pixel gaps in both horizontal and vertical directions.

## 14.6 Effective Use of Nested Panels

In this section, we will discuss how to nest panels effectively to get a desired layout of GUI components. It is possible, but very difficult, to place all GUI components on a single `JPanel` or other types of containers. A better approach is to use multiple panels, placing panels inside other panels. To illustrate this technique, we will create two sample frames that contain nested panels. The first sample, shown in Figure 14.17, provides the user interface for playing Tic Tac Toe. And the second sample, shown in Figure 14.18, provides the user interface for playing HiLo. Note that we only illustrate the visual layout using nested panels. The sample frames do not include any code for actually playing the games.

The frame shown in Figure 14.17 has four panels. The topmost `JPanel`, the content pane of the frame, has a border layout. The content pane's center region is

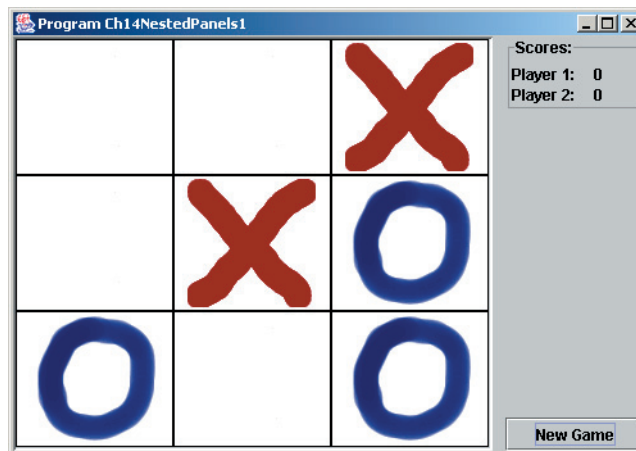

**Figure 14.17** A sample frame that contains nested panels. Four `JPanel` objects are used in this frame.

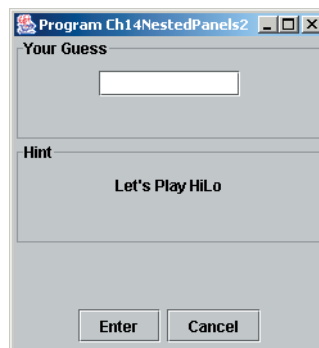

**Figure 14.18** Another sample frame that contains nested panels. Five `JPanel` objects are used in this frame.

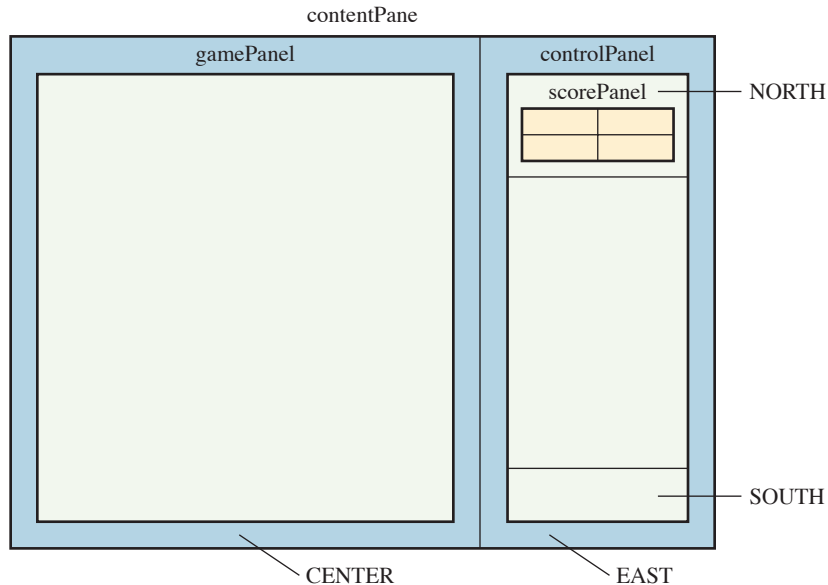

**Figure 14.19** This diagram shows how the panels of the frame in Figure 14.17 are nested. There are four **JPanel** objects. We associate a border layout to both **contentPane** and **controlPanel** and a grid layout to **scorePanel**. The **gamePanel** is a specialized **JPanel** (it's a subclass of **JPanel**) that uses a grid layout.

occupied by an instance of `Ch14TicTacToePanel` named `gamePanel`. `Ch14TicTacToePanel` is itself a nested panel. We will design and implement this panel at the end of this section. The content pane's east region is occupied by an instance of another `JPanel` named `controlPanel`. A border layout is used for this panel. The north region of `controlPanel` is occupied by another `JPanel` named `scorePanel`, and the south region is occupied by a `JButton`. The layout for `scorePanel` is set to a grid layout with four grids, each occupied by a `JLabel` object. The nesting relationship is shown in Figure 14.19.

When we nest panels, it is often very useful to mark their borders. In this sample frame, we use a titled border for `scorePanel` and a lowered bevel border for `gamePanel`. A titled border draws a rectangle around the panel and displays a designated title. We create a titled border by calling the class method `createTitledBorder` of the `BorderFactory` class and assign to a panel by calling the `setBorder` method. Here's the statement:

```
scorePanel.setBorder(
 BorderFactory.createTitledBorder("Scores:"));
```

A lowered bevel border gives an illusion of the panel being recessed into the frame. Here's the statement to create and set the lowered bevel border to `gamePanel`:

```
gamePanel.setBorder(
 BorderFactory.createLoweredBevelBorder());
```

Additional types of borders, such as line border, matte border, and raised bevel border, are available. For more information, please consult the documentation for the `BorderFactory` class.

Here's the complete listing of the program:

```

/*
 Chapter 14 Sample Program: Illustrates the use of
 nested panels

 File: Ch14NestedPanels1.java
*/

import javax.swing.*;
import java.awt.*;

class Ch14NestedPanels1 extends JFrame {

 private static final int FRAME_WIDTH = 500;
 private static final int FRAME_HEIGHT = 350;
 private static final int FRAME_X_ORIGIN = 150;
 private static final int FRAME_Y_ORIGIN = 250;

 public static void main(String[] args) {
 Ch14NestedPanels1 frame = new Ch14NestedPanels1();
 frame.setVisible(true);
 }

 public Ch14NestedPanels1() {
 Container contentPane;
 Ch14TicTacToePanel gamePanel;
 JPanel controlPanel;
 JPanel scorePanel;

 //set the frame properties
 setSize (FRAME_WIDTH, FRAME_HEIGHT);
 setTitle ("Program Ch14NestedPanels1");
 setLocation (FRAME_X_ORIGIN, FRAME_Y_ORIGIN);

 contentPane = getContentPane();
 contentPane.setLayout(new BorderLayout(10, 0));

 gamePanel = new Ch14TicTacToePanel();
 gamePanel.setBorder(BorderFactory.createLoweredBevelBorder());
 controlPanel = new JPanel();
 controlPanel.setLayout(new BorderLayout());

 contentPane.add(gamePanel, BorderLayout.CENTER);
 contentPane.add(controlPanel, BorderLayout.EAST);

 scorePanel = new JPanel();
 scorePanel.setBorder(BorderFactory.createTitledBorder("Scores:"));
 }
}

```

```

scorePanel.setLayout(new GridLayout(2, 2));
scorePanel.add(new JLabel("Player 1:"));
scorePanel.add(new JLabel(" 0"));
scorePanel.add(new JLabel("Player 2:"));
scorePanel.add(new JLabel(" 0"));

controlPanel.add(scorePanel, BorderLayout.NORTH);
controlPanel.add(new JButton("New Game"), BorderLayout.SOUTH);

//register 'Exit upon closing' as a default close operation
setDefaultCloseOperation(EXIT_ON_CLOSE);
}
}

```

Remember that this class illustrates only the visual aspect of the program. There is no code for handling events or actually playing the game.

Now let's move on to the second sample frame. For this frame, we will use nested panels shown in Figure 14.20. Notice the panel that has a BorderLayout. This panel seems extra, but without it, the buttons will appear away from the bottom, closer to the response label. We feel it is more appealing visually when the buttons are placed at the bottom.

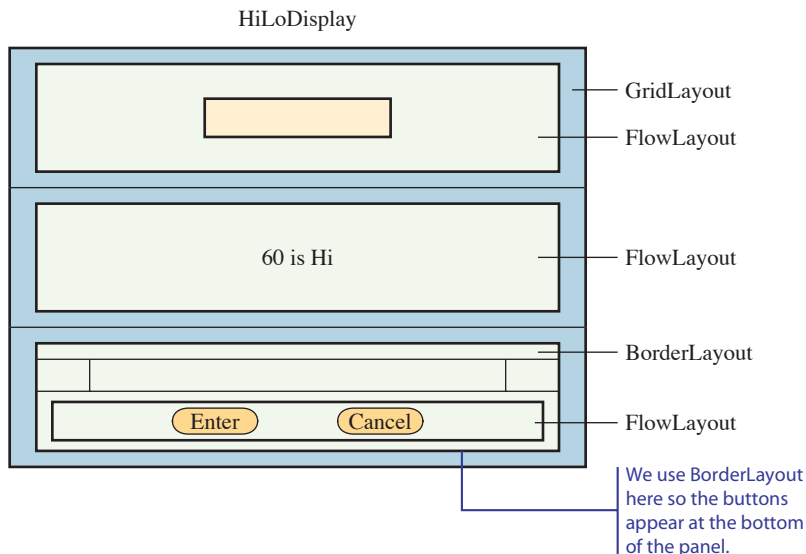

**Figure 14.20** The nested panels and associated layout managers for `HiLoDisplay`.

Here's the Ch14NestedPanels2 class:

```

/*
Chapter 14 Sample Program: Illustration of Nested Panels

File: Ch14NestedPanels2.java
*/

import javax.swing.*;
import java.awt.*;

class Ch14NestedPanels2 extends JFrame {

 private static final int FRAME_WIDTH = 250;
 private static final int FRAME_HEIGHT = 270;
 private static final int FRAME_X_ORIGIN = 150;
 private static final int FRAME_Y_ORIGIN = 250;

 private final String ENTER = "Enter";
 private final String CANCEL = "Cancel";
 private final String BLANK = "";

 private JTextField guessEntry;
 private JLabel hint;

 public static void main(String[] args) {
 Ch14NestedPanels2 frame = new Ch14NestedPanels2();
 frame.setVisible(true);
 }

 public Ch14NestedPanels2() {
 JPanel guessPanel, hintPanel,
 controlPanel, buttonPanel;

 JButton enterBtn, cancelBtn;

 Container contentPane;

 //set the frame properties
 setSize (FRAME_WIDTH, FRAME_HEIGHT);
 setTitle ("Program Ch14NestedPanels2");
 setLocation(FRAME_X_ORIGIN, FRAME_Y_ORIGIN);

 contentPane = getContentPane();

 contentPane.setLayout(new GridLayout(3, 1));

 guessPanel = new JPanel();
 guessPanel.setBorder(BorderFactory.createTitledBorder(
 "Your Guess"));
 guessPanel.add(guessEntry = new JTextField(10));
 }
}

```

```

hintPanel = new JPanel();
hintPanel.setBorder(BorderFactory.createTitledBorder("Hint"));
hintPanel.add(hint = new JLabel("Let's Play HiLo"));

controlPanel = new JPanel(new BorderLayout());
buttonPanel = new JPanel();
buttonPanel.add(enterBtn = new JButton(ENTER));
buttonPanel.add(cancelBtn = new JButton(CANCEL));
controlPanel.add(buttonPanel, BorderLayout.SOUTH);

contentPane.add(guessPanel);
contentPane.add(hintPanel);
contentPane.add(controlPanel);
}
}

```

### Tic Tac Toe Panel

As promised, let's design and implement a panel specialized in displaying the Tic Tac Toe board of  $N \times N = N^2$  cells (default is  $3 \times 3 = 9$  cells). Figure 14.17 shows this Tic Tac Toe panel placed on a frame. The panel handles the mouse click events, so every time the player clicks on the cell, the circle or cross is displayed. However, this code for handling mouse click events is only for demonstration. There's no logic of actually playing the game of Tic Tac Toe. For instance, when we click on the cell that already has a cross or circle, a new mark replaces the current one. In the real game, this should not happen. The demonstration code simply alternates between the cross and circle. When we click the panel for the first time, the circle is placed, then the cross, then the circle, and so forth.

How shall we implement this panel? There are two approaches. The first approach is to compute the origin point—the top left corner—of each cell based on the dimension of the panel and the number of cells in the panel. When we know the origin point of a cell, then we can draw a circle or cross by using the `drawLine` and `drawOval` methods. Figure 14.21 illustrates how this is done. When a cell is clicked, we get the  $x$  and  $y$  coordinates of the mouse click location and determine in which cell the mouse click event has occurred. Once we know the cell, we use its origin point to draw a circle or cross at the correct position and size. This approach requires a fair amount of coding to determine the cell and the correct position to draw lines and circles. We can avoid all these computations by using the second approach.

The second approach, the one which we will adopt here, uses the nested panels. We will define two classes—`Ch14TicTacToePanel` and `Ch14TicTacToeCell`—both subclasses of `JPanel`. An instance of `Ch14TicTacToePanel` will contain  $N^2$  instances of `Ch14TicTacToeCell`, each instance representing a single cell in the Tic Tac Toe board. A `Ch14TicTacToeCell` object contains one component, namely, an instance of `JLabel`. Instead of a text, we assign an image icon to this `JLabel` object. We have



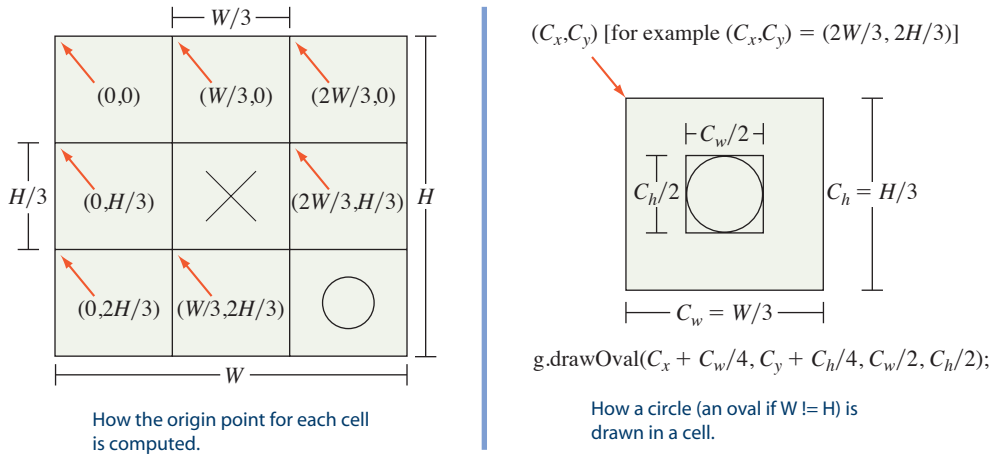

**Figure 14.21** The approach not adopted here. This approach is left as Exercise 14. The panel is divided into equal-size cells. A circle or cross can be drawn by using the **drawOval** or **drawLine** method at the position slightly offset from the origin point of the cell.

three image files: the first one for the circle, the second for the cross, and the last one for a blank cell. These files are named `circle.gif`, `cross.gif`, and `blank.gif`, respectively. All three images have a transparent background so the background color of the `Ch14TicTacToeCell` will be visible. Notice that these image files must be put in the same folder as the class files `Ch14TicTacToePanel.class` and `Ch14TicTacToeCell.class`. Initially, all cells are assigned the `blank.gif` image. And we set a line border for each cell so the boundary lines are visible. Without such boundary lines, we wouldn't be able to tell how many cells the board had and where each cell began and ended. When a cell is clicked, `Ch14TicTacToePanel` will set it to a cross or a circle by calling the cell's `setContent` method.

The class includes one data member called `location`, a `Point` object, to record the cell's position on the Tic Tac Toe board. This information is not used in this sample. We need to process the location information when we develop the complete Tic Tac Toe playing program.

Here's the complete listing of the `Ch14TicTacToeCell` class:

```

/*
 Chapter 14 Sample Program: Tic Tac Toe

 File: Ch14TicTacToeCell.java
*/

import java.awt.*;
import javax.swing.*;

public class Ch14TicTacToeCell extends JPanel {
 public static enum Image {BLANK,CIRCLE,CROSS}

```

```
private static final String CROSS_IMAGE_FILE = "cross.gif";
private static final String CIRCLE_IMAGE_FILE = "circle.gif";
private static final String BLANK_IMAGE_FILE = "blank.gif";

private JLabel content;
private Point location;

public Ch14TicTacToeCell() {
 this(null);
}

public Ch14TicTacToeCell(Point pt) {

 ImageIcon initImage = new ImageIcon("blank.gif");

 setLayout(new BorderLayout());
 setBackground(Color.white);
 setBorder(BorderFactory.createLineBorder(Color.BLACK));

 content = new JLabel(initImage);
 add(content);

 location = pt;
}

public Point getPosition() {
 return location;
}

public void setContent(Image image) {

 switch (image) {

 case CIRCLE: content.setIcon(new ImageIcon(CIRCLE_IMAGE_FILE));
 break;

 case CROSS: content.setIcon(new ImageIcon(CROSS_IMAGE_FILE));
 break;

 default: //do nothing
 break;
 }
}
}
```

The main tasks for the `Ch14TicTacToePanel` to handle are the layout of  $N^2$  `Ch14TicTacToeCell` objects and the mouse click events. Since the board is divided into equal-size cells, the grid layout is the perfect layout manager to use here. By using the grid layout manager, the images will stay at the center of the cells even when the panel is resized.

Each cell is the source of mouse events, and the container of these cells, that is, an instance of `Ch14TicTacToePanel`, is designated as the listener of the mouse events. Again, the event-handling code for this class is temporary. We will set an image of a circle or a cross to the clicked cell. There's no logic here to actually play the game, for example, to determine the winner. Here's the complete listing of the `Ch14TicTacToePanel` class:

```

/*
Chapter 14 Sample Program: Tic Tac Toe Board

File: Ch14TicTacToePanel.java
*/

import java.awt.*;
import javax.swing.*;
import java.awt.event.*;

public class Ch14TicTacToePanel extends JPanel implements MouseListener {
 private boolean circle;

 public Ch14TicTacToePanel() {
 this(3);
 }

 public Ch14TicTacToePanel(int size) {
 Ch14TicTacToeCell cell;

 setLayout(new GridLayout(size, size));

 for (int row = 0; row < size; row++) {
 for (int col = 0; col < size; col++) {
 cell = new Ch14TicTacToeCell();

 cell.addMouseListener(this);
 add(cell);
 }
 }

 circle = true;
 }

 public void mouseClicked(MouseEvent event) {
 Ch14TicTacToeCell cell = (Ch14TicTacToeCell) event.getSource();

 if (circle) {
 cell.setContent(Ch14TicTacToeCell.Image.CIRCLE);
 } else {
 cell.setContent(Ch14TicTacToeCell.Image.CROSS);
 }
 }
}

```

```

 circle = !circle;
 }

 public void mouseEntered (MouseEvent event) { }
 public void mouseExited (MouseEvent event) { }
 public void mousePressed (MouseEvent event) { }
 public void mouseReleased (MouseEvent event) { }
}

```

## 14.7 Other GUI Components

We will introduce other useful Swing components in this section. Please keep in mind that we limit the discussion to the most basic use of these components. They are actually far more capable than what we present here. However, the materials presented in this section should be enough to let you use them in most common situations and should serve as a good starting point from which you can explore more advanced uses of these components on your own.

### JCheckBox

The JButton class represents a type of button called a *pushbutton*. Two other common types of buttons are called *check-box* and *radio buttons*. We will explain the check-box buttons in this subsection and the radio buttons in the next subsection.

The JCheckBox class is used to represent check-box buttons. Figure 14.22 shows a frame with four check-box buttons and one pushbutton. Check-box buttons are useful in presenting a collection of binary (yes/no, true/false) options. The frame shown in Figure 14.22 gives the user the option to select the programming languages he or she can program with by clicking on the appropriate check-box button.

We deal with the JCheckBox class in a manner very similar to that for the JButton class. To create a check-box button with a text Java, we write

```
JCheckBox cbBtn = new JCheckBox("Java");
```

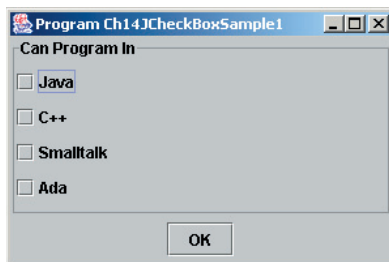

The state when the frame first appeared on the screen.

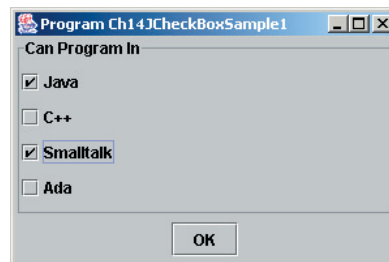

The state after the two check-box buttons are clicked.

**Figure 14.22** A frame with four check-box buttons and one pushbutton.

To check if a check-box button is selected (i.e., has a check mark) or deselected, we call its `isSelected` method. For example,

```
if (cbBtn.isSelected()) {
 System.out.println("You can program in"
 + cbBtn.getText());
} else {
 System.out.println("You cannot program in "
 + cbBtn.getText ());
}
```

Just as with a pushbutton, we can retrieve the text associated to a check-box button by calling its `getText` method. We can use the corresponding `setText` method to change the button text.

The following `Ch14JCheckBoxSample1` class displays the frame shown in Figure 14.22. When the OK pushbutton is clicked, we respond by opening a message dialog with a list of selected programming languages. In the program, notice the use of an array of string `btnText` in creating an array of `JCheckBox` buttons. We can easily list any number of names by simply including all names when `btnText` is initialized, for example,

```
String[] btnText = {"Java", "C++", "Smalltalk", "Ada",
 "COBOL", "Algol", "Pascal", "BASIC"};
```

There's no need to modify the program code. The ease of achieving this generality is a direct benefit of using panels and layout managers instead of absolute positioning. (You still can do it, but it would be a lot more tedious work to code the same capability with absolute positioning.)

Here's the class:

```
/*
Chapter 14 Sample Program: Illustrates the use of JCheckBox

File: Ch14JCheckBoxSample1.java
*/

import javax.swing.*;
import java.awt.*;
import java.awt.event.*;

class Ch14JCheckBoxSample1 extends JFrame implements ActionListener {

 private static final int FRAME_WIDTH = 300;
 private static final int FRAME_HEIGHT = 200;
 private static final int FRAME_X_ORIGIN = 150;
 private static final int FRAME_Y_ORIGIN = 250;
```

```
private JCheckBox[] checkBox;

public static void main(String[] args) {
 Ch14JCheckBoxSample1 frame = new Ch14JCheckBoxSample1();
 frame.setVisible(true);
}

public Ch14JCheckBoxSample1() {
 Container contentPane;
 JPanel checkPanel, okPanel;

 JButton okButton;
 String[] btnText = {"Java", "C++", "Smalltalk", "Ada"};

 //set the frame properties
 setSize (FRAME_WIDTH, FRAME_HEIGHT);
 setTitle ("Program Ch14JCheckBoxSample1");
 setLocation(FRAME_X_ORIGIN, FRAME_Y_ORIGIN);

 contentPane = getContentPane();
 contentPane.setBackground(Color.WHITE);
 contentPane.setLayout(new BorderLayout());

 //create and place four check boxes
 checkPanel = new JPanel(new GridLayout(0,1));
 checkPanel.setBorder(BorderFactory.createTitledBorder(
 "Can Program In"));
 checkBox = new JCheckBox[btnText.length];

 for (int i = 0; i < checkBox.length; i++) {
 checkBox[i] = new JCheckBox(btnText[i]);
 checkPanel.add(checkBox[i]);
 }

 //create and place the OK button
 okPanel = new JPanel(new FlowLayout());
 okButton = new JButton("OK");
 okButton.addActionListener(this);
 okPanel.add(okButton);

 contentPane.add(checkPanel, BorderLayout.CENTER);
 contentPane.add(okPanel, BorderLayout.SOUTH);

 //register 'Exit upon closing' as a default close operation
 setDefaultCloseOperation(EXIT_ON_CLOSE);
}

public void actionPerformed(ActionEvent event) {

 StringBuffer skill = new StringBuffer("You can program in\n");
 for (int i = 0; i < checkBox.length; i++) {
```

```

 if (checkBox[i].isSelected()) {
 skill.append(checkBox[i].getText() + "\n ");
 }
 }
 JOptionPane.showMessageDialog(this, skill.toString());
}
}

```

## item events

Although we did not process them in the Ch14JCheckBoxSample1 program, a JCheckBox object generates action events just as any other buttons do. So we can associate an action listener to JCheckBox objects, but it is not that common to process action events generated by JCheckBox objects. In addition, a JCheckBox object generates another type of event called *item events*. An item event is generated when the state (selected or deselected) of a check-box button changes. We can register an instance of a class that implements the ItemListener interface as an item listener of a JCheckBox object. When an item event is generated, its itemStateChanged method is called. Inside the method, we can check the state of change by calling the getStateChange method. Here's a sample itemStateChanged method:

```

public void itemStateChanged(ItemEvent event) {
 if (event.getStateChange() == ItemEvent.SELECTED) {
 System.out.println("You checked the box");
 } else {
 System.out.println("You unchecked the box");
 }
}
}

```

Here's the Ch14JCheckBoxSample2 class that adds the item event handling to the Ch14JCheckBoxSample1 class:

```

/*
 Chapter 14 Sample Program: Illustrates the use of JCheckBox
 File: Ch14JCheckBoxSample2.java
*/

import javax.swing.*;
import java.awt.*;
import java.awt.event.*;

class Ch14JCheckBoxSample2 extends JFrame
 implements ActionListener,
 ItemListener {

```

```
private static final int FRAME_WIDTH = 300;
private static final int FRAME_HEIGHT = 200;
private static final int FRAME_X_ORIGIN = 150;
private static final int FRAME_Y_ORIGIN = 250;

private JCheckBox[] checkBox;

public static void main(String[] args) {
 Ch14JCheckBoxSample2 frame = new Ch14JCheckBoxSample2();
 frame.setVisible(true);
}

public Ch14JCheckBoxSample2() {
 Container contentPane;
 JPanel checkPanel, okPanel;

 JButton okButton;
 String[] btnText = {"Java", "C++", "Smalltalk", "Ada"};

 //set the frame properties
 setSize (FRAME_WIDTH, FRAME_HEIGHT);
 setTitle ("Program Ch14JCheckBoxSample2");
 setLocation(FRAME_X_ORIGIN, FRAME_Y_ORIGIN);

 contentPane = getContentPane();
 contentPane.setBackground(Color.WHITE);
 contentPane.setLayout(new BorderLayout());

 //create and place four check boxes
 checkPanel = new JPanel(new GridLayout(0,1));
 checkPanel.setBorder(BorderFactory.createTitledBorder(
 "Can Program In"));

 checkBox = new JCheckBox[btnText.length];

 for (int i = 0; i < checkBox.length; i++) {
 checkBox[i] = new JCheckBox(btnText[i]);
 checkPanel.add(checkBox[i]);

 checkBox[i].addItemListener(this);
 }

 //create and place the OK button
 okPanel = new JPanel(new FlowLayout());
 okButton = new JButton("OK");
 okButton.addActionListener(this);
 okPanel.add(okButton);

 contentPane.add(checkPanel, BorderLayout.CENTER);
 contentPane.add(okPanel, BorderLayout.SOUTH);

 //register 'Exit upon closing' as a default close operation
 setDefaultCloseOperation(EXIT_ON_CLOSE);
}
```



```

public void actionPerformed(ActionEvent event) {
 StringBuffer skill = new StringBuffer("You can program in\n");
 for (int i = 0; i < checkBox.length; i++) {
 if (checkBox[i].isSelected()) {
 skill.append(checkBox[i].getText() + "\n ");
 }
 }
 JOptionPane.showMessageDialog(this, skill.toString());
}

public void itemStateChanged(ItemEvent event) {
 JCheckBox source = (JCheckBox) event.getSource();
 String state;
 if (event.getStateChange() == ItemEvent.SELECTED) {
 state = "is selected";
 } else {
 state = "is deselected";
 }
 JOptionPane.showMessageDialog(this, "JCheckBox '" +
 source.getText() +
 "' " + state);
}
}

```

### JRadioButton

The `JRadioButton` class is used to represent a type of button called a *radio button*. Similar to a check-box button, you can select or deselect a radio button. But unlike with a check-box button, you can only select one of the radio buttons that belong to the same group. Figure 14.23 shows a frame with four radio buttons and one push-button. We can select exactly one of the four radio buttons at a time because they belong to the same group. When we select a new one, then the currently selected radio button will get deselected. Radio buttons are useful in allowing the user to select one from a list of possible choices. The sample frame in Figure 14.23 allows the user to select the favorite programming language.

We can use the `JRadioButton` class in almost an identical manner as that for the `JCheckBox` class. Like `JCheckBox`, `JRadioButton` generates both action events and item events. The key difference is the requirement to add `JRadioButton` objects to a button group, in addition to adding them to a container. Notice that the addition of radio buttons to a group is a logical operation (only one radio button in a group can be selected at a time), and the addition of radio buttons to a container is a visual

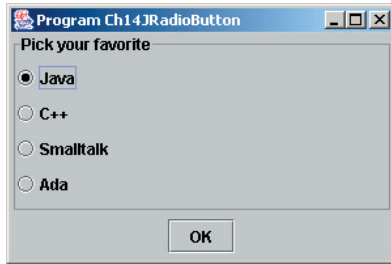

The state when the frame first appeared on the screen.

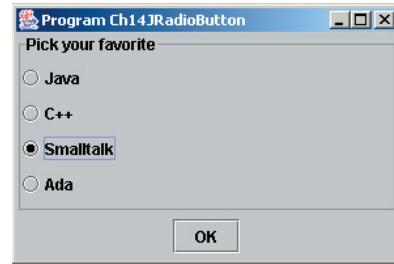

The state after the third radio button is clicked. Previous selection gets deselected.

**Figure 14.23** A frame with four radio buttons and one pushbutton.

layout operation. Here's a portion that creates radio buttons and adds them to a group (an instance of a `ButtonGroup`) and a container (an instance of a `JPanel`):

```
ButtonGroup languageGroup = new ButtonGroup();
JPanel radioPanel = new JPanel(...);

for (int i = 0; i < radioButton.length; i++) {
 radioButton[i] = new JRadioButton(...);
 ...
 languageGroup.add(radioButton[i]);
 radioPanel.add(radioButton[i]);
}
```

(Three dots `...` represent a piece of actual code not directly relevant here.)

Here's the `Ch14JRadioButtonSample` class:

```
/*
 Chapter 14 Sample Program: Illustrates the use of JRadioButton
 File: Ch14JRadioButtonSample.java
*/

import javax.swing.*;
import java.awt.*;
import java.awt.event.*;

class Ch14JRadioButtonSample extends JFrame
 implements ActionListener,
 ItemListener {

 private static final int FRAME_WIDTH = 300;
 private static final int FRAME_HEIGHT = 200;
 private static final int FRAME_X_ORIGIN = 150;
 private static final int FRAME_Y_ORIGIN = 250;
```

```

private JRadioButton[] radioButton;

public static void main(String[] args) {
 Ch14JRadioButtonSample frame = new Ch14JRadioButtonSample();
 frame.setVisible(true);
}

public Ch14JRadioButtonSample() {
 Container contentPane;
 JPanel radioPanel, okPanel;
 ButtonGroup languageGroup;

 JButton okButton;
 String[] btnText = {"Java", "C++", "Smalltalk", "Ada"};

 //set the frame properties
 setSize (FRAME_WIDTH, FRAME_HEIGHT);
 setTitle ("Program Ch14JRadioButton");
 setLocation(FRAME_X_ORIGIN, FRAME_Y_ORIGIN);

 contentPane = getContentPane();
 contentPane.setBackground(Color.WHITE);
 contentPane.setLayout(new BorderLayout());

 //create and place four radio buttons
 radioPanel = new JPanel(new GridLayout(0,1));
 radioPanel.setBorder(BorderFactory.createTitledBorder(
 "Pick your favorite"));

 languageGroup = new ButtonGroup();
 radioButton = new JRadioButton[btnText.length];

 for (int i = 0; i < radioButton.length; i++) {
 radioButton[i] = new JRadioButton(btnText[i]);
 radioButton[i].addItemListener(this);
 languageGroup.add(radioButton[i]);
 radioPanel.add(radioButton[i]);
 }

 radioButton[0].setSelected(true); //selects the first choice

 //create and place the OK button
 okPanel = new JPanel(new FlowLayout());
 okButton = new JButton("OK");
 okButton.addActionListener(this);
 okPanel.add(okButton);

 contentPane.add(radioPanel, BorderLayout.CENTER);
 contentPane.add(okPanel, BorderLayout.SOUTH);

 //register 'Exit upon closing' as a default close operation
 setDefaultCloseOperation(EXIT_ON_CLOSE);
}

```

```

public void actionPerformed(ActionEvent event) {
 String favorite = null;

 int i = 0;
 while (favorite == null) {
 if (radioButton[i].isSelected()) {
 favorite = radioButton[i].getText();
 }
 i++;
 }

 JOptionPane.showMessageDialog(this, "Your favorite language is "
 + favorite);
}

public void itemStateChanged(ItemEvent event) {
 JRadioButton source = (JRadioButton) event.getSource();

 String state;

 if (event.getStateChange() == ItemEvent.SELECTED) {
 state = "is selected";
 } else {
 state = "is deselected";
 }

 JOptionPane.showMessageDialog(this, "JRadioButton '" +
 source.getText() +
 "' " + state);
}
}

```

Every time a radio button is selected, the `itemStateChanged` method is called twice. The first time is for the deselection of the currently selected item, and the second is for the selection of the new item. Also notice the statement

```
radioButton[0].setSelected(true);
```

in the constructor. If we don't include this statement, then no item will be selected when the frame is first opened. For radio buttons, it is more common to start with one preselected when they first appear on the screen.

### JComboBox

The `JComboBox` class presents a combo box. This class is similar to the `JRadioButton` class in that it also allows the user to select one item from a list of possible choices. The

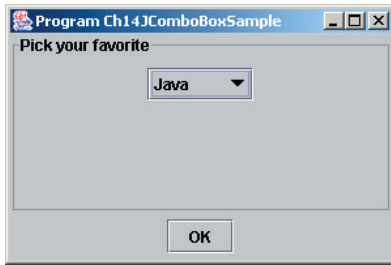

The state when the frame first appeared on the screen.

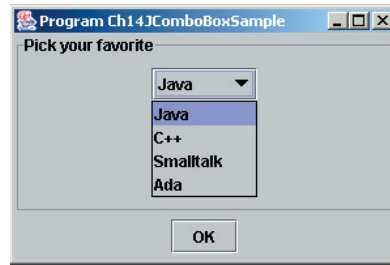

The state after the items in the combo box are revealed by clicking on the down arrow.

**Figure 14.24** A frame with one combo box (drop-down list) and one pushbutton.

difference between the two lies in how the choices are presented to the user. Another name for a combo box is a *drop-down list*, which is more descriptive of its interaction style. Figure 14.24 shows a frame with one combo box and one pushbutton.

We can construct a new `JComboBox` by passing an array of `String` objects, for example,

```
String[] comboBoxItem
 = {"Java", "C++", "Smalltalk", "Ada"};

JComboBox comboBox = new JComboBox(comboBoxItem);
```

A `JComboBox` object generates both action events and item events. An action event is generated every time a `JComboBox` is clicked (note it is not that common to process action events of `JComboBox`). Every time an item different from the currently selected item is selected, an item event is generated and the `itemStateChanged` method is called twice. The first time is for the deselection of the currently selected item, and the second is for the selection of the new item. Notice that when the same item is selected again, no item event is generated.

To find out the currently selected item, we call the `getSelectedItem` method of `JComboBox`. Because the return type of this method is `Object`, we must typecast to the correct type. For this example, items are `String` objects, so we write

```
String selection = (String) comboBox.getSelectedItem();
```

Also, we can call the `getSelectedIndex` method to retrieve the position of the selected item. The first item in the list is at position 0.

Here's the `Ch14JComboBoxSample` class:

```
/*
Chapter 14 Sample Program: Illustrates the use of JComboBox
File: Ch14JComboBoxSample.java
*/
```

```
import javax.swing.*;
import java.awt.*;
import java.awt.event.*;

class Ch14JComboBoxSample extends JFrame
 implements ActionListener,
 ItemListener {

 private static final int FRAME_WIDTH = 300;
 private static final int FRAME_HEIGHT = 200;
 private static final int FRAME_X_ORIGIN = 150;
 private static final int FRAME_Y_ORIGIN = 250;

 private JComboBox comboBox;

 public static void main(String[] args) {
 Ch14JComboBoxSample frame = new Ch14JComboBoxSample();
 frame.setVisible(true);
 }

 public Ch14JComboBoxSample() {
 Container contentPane;
 JPanel comboPanel, okPanel;

 JButton okButton;
 String[] comboBoxItem = {"Java", "C++", "Smalltalk", "Ada"};

 //set the frame properties
 setSize (FRAME_WIDTH, FRAME_HEIGHT);
 setTitle ("Program Ch14JComboBoxSample");
 setLocation(FRAME_X_ORIGIN, FRAME_Y_ORIGIN);

 contentPane = getContentPane();
 contentPane.setBackground(Color.WHITE);
 contentPane.setLayout(new BorderLayout());

 //create and place a combo box
 comboPanel = new JPanel(new FlowLayout());
 comboPanel.setBorder(BorderFactory.createTitledBorder(
 "Pick your favorite"));

 comboBox = new JComboBox(comboBoxItem);
 comboBox.addItemListener(this);
 comboPanel.add(comboBox);

 //create and place the OK button
 okPanel = new JPanel(new FlowLayout());
 okButton = new JButton("OK");
 okButton.addActionListener(this);
 okPanel.add(okButton);

 contentPane.add(comboPanel, BorderLayout.CENTER);
 contentPane.add(okPanel, BorderLayout.SOUTH);
 }
}
```

```

 //register 'Exit upon closing' as a default close operation
 setDefaultCloseOperation(EXIT_ON_CLOSE);
}

public void actionPerformed(ActionEvent event) {

 String favorite;
 int loc;

 favorite = (String) comboBox.getSelectedItemAt();
 loc = comboBox.getSelectedIndex();

 JOptionPane.showMessageDialog(this, "Currently selected item '" +
 favorite + "' is at index position " + loc);
}

public void itemStateChanged(ItemEvent event) {

 String state;

 if (event.getStateChange() == ItemEvent.SELECTED) {
 state = "is selected ";
 } else {
 state = "is deselected ";
 }

 JOptionPane.showMessageDialog(this, "JComboBox Item '" +
 event.getItem() +
 "' " + state);
}
}
}

```

## JList

The `JList` class is useful when we need to display a list of items, for example, a list of students, a list of files, and so forth. Figure 14.25 shows a frame with one `JList` listing animals with three-letter names and one pushbutton.

We can construct a `JList` object in a manner identical to the way we construct a `JComboBox` object, that is, by passing an array of `String`, such as

```

String[] names = {"Ape", "Bat", "Bee", "Cat",
 "Dog", "Eel", "Fox", "Gnu",
 "Hen", "Man", "Sow", "Yak"};
JList list = new JList (names);

```

With `JList`, we have an option of specifying one of the three selection modes: single-selection, single-interval, and multiple-interval. The single-selection mode allows the user to select only one item at a time. The single-interval mode allows the user to select a single contiguous interval. And the multiple-interval mode allows

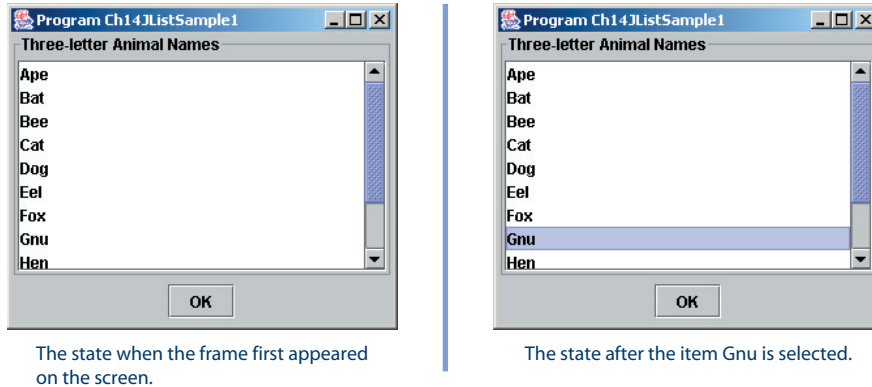

**Figure 14.25** A frame with one list and one pushbutton.

the user to select multiple contiguous intervals (each interval will include one or more items). The multiple-interval mode is the default mode. The following three statements show how to set the three selection modes:

```
list.setSelectionMode(
 ListSelectionModel.SINGLE_SELECTION);

list.setSelectionMode(
 ListSelectionModel.SINGLE_INTERVAL_SELECTION);

list.setSelectionMode(
 ListSelectionModel.MULTIPLE_INTERVAL_SELECTION);
```

Because multiple items can be selected, we use `getSelectedValues` and `getSelectedIndices` to retrieve an array of selected items and an array of the indices of the selected items, respectively. The following code will display the selected items and their index positions:

```
Object[] name;
int[] loc;

name = list.getSelectedValues();
loc = list.getSelectedIndices();

for (int i = 0; i < name.length; i++) {
 System.out.println("(" + name[i] +
 " at position " + loc[i]);
}
```

The return type of `getSelectedValues` is an array of `Object`, so we typecast each item in the `name` array to `String` before printing it on `System.out`. If we know the selection mode is single selection, then we can use `getSelectedValue` and `getSelectedIndex` instead. Notice in the code that we are not adding a `JList` object directly to a panel. Instead, we wrap it in a `JScrollPane` and add this `JScrollPane` to a panel because `JList` itself does not include scroll bars.



Here's the Ch14JListSample class:

```

/*
 Chapter 14 Sample Program: Illustrates the use of JList

 File: Ch14JListSample.java
*/

import javax.swing.*;
import java.awt.*;
import java.awt.event.*;

class Ch14JListSample extends JFrame
 implements ActionListener {

 private static final int FRAME_WIDTH = 300;
 private static final int FRAME_HEIGHT = 250;
 private static final int FRAME_X_ORIGIN = 150;
 private static final int FRAME_Y_ORIGIN = 250;

 private JList list;

 public static void main(String[] args) {
 Ch14JListSample frame = new Ch14JListSample();
 frame.setVisible(true);
 }

 public Ch14JListSample() {
 Container contentPane;
 JPanel listPanel, okPanel;

 JButton okButton;
 String[] names = {"Ape", "Bat", "Bee", "Cat",
 "Dog", "Eel", "Fox", "Gnu",
 "Hen", "Man", "Sow", "Yak"};

 //set the frame properties
 setSize (FRAME_WIDTH, FRAME_HEIGHT);
 setTitle ("Program Ch14JListSample2");
 setLocation(FRAME_X_ORIGIN, FRAME_Y_ORIGIN);

 contentPane = getContentPane();
 contentPane.setBackground(Color.WHITE);
 contentPane.setLayout(new BorderLayout());

 //create and place a JList
 listPanel = new JPanel(new GridLayout(0,1));
 listPanel.setBorder(BorderFactory.createTitledBorder(
 "Three-letter Animal Names"));

 list = new JList(names);
 listPanel.add(new JScrollPane(list));
 }
}

```

```

list.setSelectionMode(
 ListSelectionMode.MULTIPLE_INTERVAL_SELECTION);
 //this is default, so the explicit call is not necessary

//create and place the OK button
okPanel = new JPanel(new FlowLayout());
okButton = new JButton("OK");
okButton.addActionListener(this);
okPanel.add(okButton);

contentPane.add(listPanel, BorderLayout.CENTER);
contentPane.add(okPanel, BorderLayout.SOUTH);

//register 'Exit upon closing' as a default close operation
setDefaultCloseOperation(EXIT_ON_CLOSE);
}

public void actionPerformed(ActionEvent event) {
 Object[] name;
 int[] loc;

 name = list.getSelectedValues();
 loc = list.getSelectedIndices();

 System.out.println("Currently selected animal names are");
 for (int i = 0; i < name.length; i++) {
 System.out.println((String)name[i] + " at position " + loc[i]);
 }
}
}
}

```

### JSlider

The `JSlider` class represents a slider in which the user can move a nob to a desired position. The position of the nob on a slider determines the selected value. Figure 14.26 shows a frame with three sliders. This is a classic example of sliders where the user moves the three nobbs to set the red, green, blue (RGB) value in selecting a color. Values for the R, G, and B range from 0 to 255, inclusive. Some of properties we can set for a `JSlider` object are the minimum and maximum range of values, whether to display the tick marks, the spacing of major and minor tick marks, whether to display the label for the major tick marks, and the placement orientation (either vertical or horizontal).

The sliders in the sample program are created and initialized in the following manner:

```

JSlider slider = new JSlider();

slider.setOrientation(JSlider.VERTICAL);
slider.setPaintLabels(true); //show tick mark labels
slider.setPaintTicks(true); //show tick marks

```

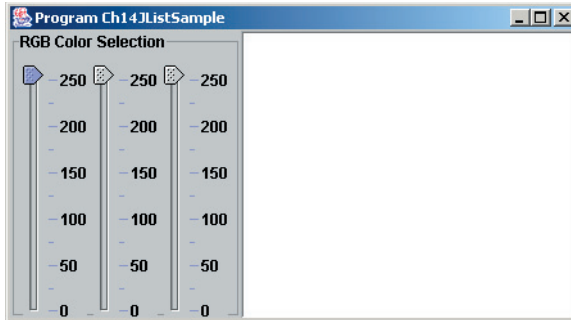

The state when the frame first appeared on the screen.

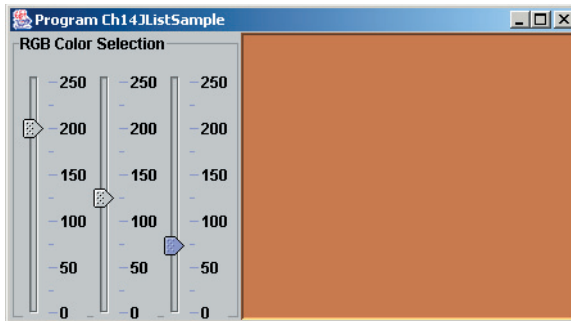

The state after three knobs are moved.

**Figure 14.26** A frame with three vertical sliders for setting an RGB value.

```
slider.setMinimum(MIN_COLOR);
slider.setMaximum(MAX_COLOR);
slider.setValue(MAX_COLOR); //initial position of a nob
slider.setMajorTickSpacing(50);
slider.setMinorTickSpacing(25);
```

When a knob is moved, a `JSlider` object generates a change event (this event occurs when there's a change in the event source, such as the knob is moved). To process change events, we must register change event listeners to a `JSlider` event source object. The class that implements the `ChangeListener` interface must define a method called `stateChanged`, whose parameter is an instance of `ChangeEvent`. For this program, whenever a change event is generated, we read the value from each slider and set the background of a panel to a designated color. Here's the body of the `stateChanged` method:

```
int R, G, B;

R = redSlider.getValue();
G = greenSlider.getValue();
B = blueSlider.getValue();

colorPanel.setBackground(new Color (R, G, B));
```

Here's the Ch14JSliderSample class:

```
/*
 Chapter 14 Sample Program: Illustrates the use of JSlider
 File: Ch14JSliderSample.java
*/

import javax.swing.event.*;
import javax.swing.*;
import java.awt.*;

class Ch14JSliderSample extends JFrame
 implements ChangeListener {

 private static final int FRAME_WIDTH = 450;
 private static final int FRAME_HEIGHT = 250;
 private static final int FRAME_X_ORIGIN = 150;
 private static final int FRAME_Y_ORIGIN = 250;

 private static final int MIN_COLOR = 0;
 private static final int MAX_COLOR = 255;

 private JSlider redSlider;
 private JSlider greenSlider;
 private JSlider blueSlider;

 private JPanel colorPanel;

 public static void main(String[] args) {
 Ch14JSliderSample frame = new Ch14JSliderSample();
 frame.setVisible(true);
 }

 public Ch14JSliderSample() {
 Container contentPane;
 JPanel sliderPanel;

 //set the frame properties
 setSize (FRAME_WIDTH, FRAME_HEIGHT);
 setTitle ("Program Ch14JListSample");
 setLocation(FRAME_X_ORIGIN, FRAME_Y_ORIGIN);

 contentPane = getContentPane();
 contentPane.setBackground(Color.WHITE);
 contentPane.setLayout(new BorderLayout());

 //create and place a JList
 sliderPanel = new JPanel(new FlowLayout());
 }
}
```

```

 sliderPanel.setBorder(BorderFactory.createTitledBorder(
 "RGB Color Selection"));

 redSlider = createSlider(MAX_COLOR);
 greenSlider = createSlider(MAX_COLOR);
 blueSlider = createSlider(MAX_COLOR);

 sliderPanel.add(redSlider);
 sliderPanel.add(greenSlider);
 sliderPanel.add(blueSlider);

 colorPanel = new JPanel();
 colorPanel.setBackground(Color.white);
 colorPanel.setBorder(BorderFactory.createLoweredBevelBorder());
 contentPane.add(colorPanel, BorderLayout.CENTER);
 contentPane.add(sliderPanel, BorderLayout.WEST);

 //register 'Exit upon closing' as a default close operation
 setDefaultCloseOperation(EXIT_ON_CLOSE);
 }

 public void stateChanged(ChangeEvent event) {

 int R, G, B;

 R = redSlider.getValue();
 G = greenSlider.getValue();
 B = blueSlider.getValue();

 colorPanel.setBackground(new Color(R, G, B));
 }

 private JSlider createSlider(int value) {

 JSlider slider = new JSlider();

 slider.setOrientation(JSlider.VERTICAL);
 slider.setPaintLabels(true);
 slider.setPaintTicks(true);
 slider.setMinimum(MIN_COLOR);
 slider.setMaximum(MAX_COLOR);
 slider.setValue(value);
 slider.setMajorTickSpacing(50);
 slider.setMinorTickSpacing(25);

 slider.addChangeListener(this);

 return slider;
 }
}

```

## 14.8 | Menus

Practical programs with a graphical user interface will almost always support menus. In this section we will describe how to display menus and process menu events by using `JMenu`, `JMenuItem`, and `JMenuBar` from the `javax.swing` package. Let's write a sample code to illustrate the display of menus and the processing of menu item selections. We will create two menus, `File` and `Edit`, with the following menu items:

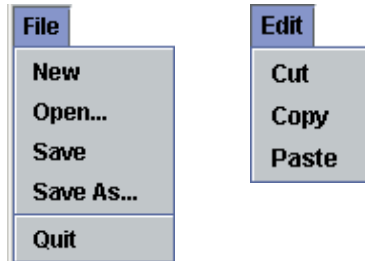

If the menu item `Quit` is selected, then we terminate the program. When a menu item other than `Quit` is selected, we print a message that identifies the selected menu item, for example,

```
Menu item 'New' is selected
```

Figure 14.27 shows a `Ch14JMenuFrame` when it is first opened and after the menu choice `Save` is selected.

One possible sequence of steps to create and add menus is this:

1. Create a `JMenuBar` object and attach it to a frame.
2. Create a `JMenu` object.
3. Create `JMenuItem` objects and add them to the `JMenu` object.
4. Attach the `JMenu` object to the `JMenuBar` object.

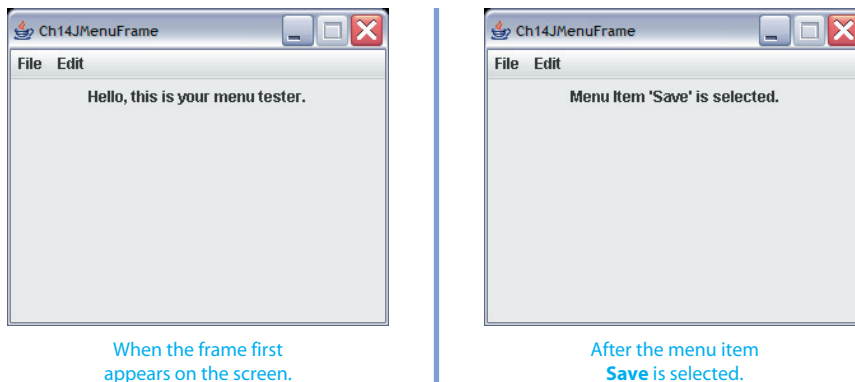

**Figure 14.27** `Ch14JMenuFrame` window when it is first opened and after the menu item **Save** is selected.

We will create two `JMenu` objects: `fileMenu` and `editMenu`. We create a `fileMenu` object as

```
fileMenu = new JMenu("File");
```

The argument to the `JMenu` constructor is the name of the menu. After the menu is created, we add a menu item to it. A menu item is the event source of menu selection, so we need to register an action listener to every menu item we add to the menu. In this sample code, we will let a `Ch14JMenuFrame` object be the action listener of all menu items. To create and add a menu item `New` to `fileMenu`, we execute

```
item = new JMenuItem("New"); //New
item.addActionListener(this);
fileMenu.add(item);
```

We repeat this sequence for all other menu items. Menu items are placed from the top in the order they are added to the menu. We can also include a horizontal line as a separator between menu items by calling the menu's `addSeparator` method.

```
fileMenu.addSeparator();
```

After the menus and their menu items are created, we attach them to a menu bar. In the constructor, we create a `JMenuBar` object, attach it to the frame by calling the frame's `setMenuBar` method, and add these two `JMenu` objects to the menu bar.

```
JMenuBar menuBar = new JMenuBar();
setMenuBar(menuBar); //attach it to the frame
menuBar.add(fileMenu);
menuBar.add(editMenu);
```

To display which menu item was selected, we use a `JLabel` object response. We add response to the frame by

```
response = new JLabel("Hello, this is your menu tester.");
response.setSize(250, 50);
contentPane.add(response);
```

When a menu item is selected, the registered action listener's `actionPerformed` method is called. The `actionPerformed` method of the `Ch14JMenuFrame` is defined as follows: If an event source is a menu item, the `getActionCommand` method of `ActionEvent` returns the menu's text. We test if the returned text is `Quit`. If it is, we terminate the program. Otherwise, we set the text of response to indicate which menu item was selected. Here's the method body of `actionPerformed`:

```
String menuName;

menuName = event.getActionCommand();

if (menuName.equals("Quit")) {
 System.exit(0);
}
```

```

 } else {
 response.setText("Menu item '" + menuName +
 "' is selected");
 }
}

```

Here's the complete Ch14JMenuFrame program:

```

/*
 Chapter 14 Sample Program: Displays a frame with two menus

 File: Ch14JMenuFrame.java
*/

import javax.swing.*;
import java.awt.*;
import java.awt.event.*;

class Ch14JMenuFrame extends JFrame implements ActionListener {

 private static final int FRAME_WIDTH = 300;
 private static final int FRAME_HEIGHT = 250;
 private static final int FRAME_X_ORIGIN = 150;
 private static final int FRAME_Y_ORIGIN = 250;

 private JLabel response;
 private JMenu fileMenu;
 private JMenu editMenu;

 //-----
 // Main method
 //-----
 public static void main(String[] args) {
 Ch14JMenuFrame frame = new Ch14JMenuFrame();
 frame.setVisible(true);
 }

 public Ch14JMenuFrame(){
 Container contentPane;

 //set the frame properties
 setTitle ("Ch14JMenuFrame");
 setSize (FRAME_WIDTH, FRAME_HEIGHT);
 setResizable(false);
 setLocation (FRAME_X_ORIGIN, FRAME_Y_ORIGIN);

 contentPane = getContentPane();
 contentPane.setLayout(new FlowLayout());

 //create two menus and their menu items
 createFileMenu();
 createEditMenu();
 }
}

```



```

//and add them to the menu bar
JMenuBar menuBar = new JMenuBar();
setJMenuBar(menuBar);
menuBar.add(fileMenu);
menuBar.add(editMenu);

//create and position response label
response = new JLabel("Hello, this is your menu tester.");
response.setSize(250, 50);
contentPane.add(response);

setDefaultCloseOperation(EXIT_ON_CLOSE);
}

public void actionPerformed(ActionEvent event) {
 String menuName;

 menuName = event.getActionCommand();

 if (menuName.equals("Quit")) {
 System.exit(0);
 } else {
 response.setText("Menu Item '" + menuName + "' is selected.");
 }
}

private void createFileMenu() {
 JMenuItem item;

 fileMenu = new JMenu("File");

 item = new JMenuItem("New"); //New
 item.addActionListener(this);
 fileMenu.add(item);

 item = new JMenuItem("Open"); //Open...
 item.addActionListener(this);
 fileMenu.add(item);

 item = new JMenuItem("Save"); //Save
 item.addActionListener(this);
 fileMenu.add(item);

 item = new JMenuItem("Save As..."); //Save As...
 item.addActionListener(this);
 fileMenu.add(item);

 fileMenu.addSeparator(); //add a horizontal separator line

 item = new JMenuItem("Quit"); //Quit
 item.addActionListener(this);
 fileMenu.add(item);
}

```

```

private void createEditMenu() {
 JMenuItem item;

 editMenu = new JMenu("Edit");

 item = new JMenuItem("Cut"); //Cut
 item.addActionListener(this);
 editMenu.add(item);

 item = new JMenuItem("Copy"); //Copy
 item.addActionListener(this);
 editMenu.add(item);

 item = new JMenuItem("Paste"); //Paste
 item.addActionListener(this);
 editMenu.add(item);
}
}

```

### Hints, & Tips, Pitfalls



If the size of text for the response label is too small, then we can make it bigger by including the following statement in the constructor:

```

response.setFont(new Font("Helvetica", /*font name*/
 Font.BOLD, /*font style*/
 16)); /*font size*/

```

### Quick CHECK



1. To which object do we register as an action listener— JMenu, JMenuItem, or JMenuBar?
2. How do we get the text of a selected menu item in the actionPerformed method?
3. How do we place a horizontal bar between two menu items?

## 14.9 | Handling Mouse Events

In this section we describe the handling of mouse events. Mouse events include such user interactions as moving the mouse, dragging the mouse (i.e., moving the mouse while the mouse button is being pressed), and clicking the mouse buttons.

Let's look at an example in which we display the  $x$  and  $y$  pixel coordinates of a location where a mouse button is pressed. We will define a subclass of `JFrame`, named `Ch14TrackMouseFrame`, that handles the left mouse button click events, and we will use `System.out` to print out the location of mouse clicks. *Note:* For a system with a one-button mouse, we treat this button as the left mouse button.

A `Ch14TrackMouseFrame` object is an event source of mouse events. We will let this object be a mouse event listener also. For a `Ch14TrackMouseFrame` object to be a mouse event listener, its class must implement `MouseListener`. This interface has five abstract methods: `mouseClicked`, `mouseEntered`, `mouseExited`, `mousePressed`, and `mouseReleased`. The argument to all five methods is an instance of `MouseEvent`.

The class declaration for `Ch14TrackMouseFrame` will look like this:

```
class Ch14TrackMouseFrame extends JFrame
 implements MouseListener {
 ...
}
```

In the constructor we set the frame properties and register this frame as a mouse event listener of itself. The constructor is defined as

```
public Ch14TrackMouseFrame {
 //set the frame properties
 ...

 //register itself as its mouse event listener
 addMouseListener(this);
}
```

When the left mouse button is clicked, the `mouseClicked` method of its mouse event listener is called. In this method, we want to find out the  $x$  and  $y$  coordinates of the mouse click point and print out these values in output. To find the  $x$  and  $y$  coordinate values, we use the `getX` and `getY` methods of `MouseEvent`. So the `mouseClicked` method of `Ch14TrackMouseFrame` is defined as

```
public void mouseClicked(MouseEvent event) {
 int x, y;

 x = event.getX(); //return the x and y coordinates
 y = event.getY(); //of a mouse click point

 System.out.println("[" + x + ", " + y + "]");
}
```

This method is called every time the left mouse button is clicked, that is, the mouse button is pressed down and released. If we want to detect the mouse button press and release separately, then we can provide a method body to the

mousePressed and mouseReleased methods. For example, if we define these methods as

```
public void mousePressed(MouseEvent event) {
 System.out.println("Down");
}
```

and

```
public void mouseReleased(MouseEvent event) {
 System.out.println("Up");
}
```

instead of empty method bodies, then we will see something like

```
Down
Up
[200,120]
```

when we click a mouse button.

Before we present the complete program, let's extend the mouseClicked method so that when the left mouse button is double-clicked, we will terminate the program. We check the number of button clicks by calling the getClickCount method of MouseEvent. Here's the method that terminates the program when a double-click occurs (a single mouse click will print out the location of a mouse click, as before):

```
private static final int DOUBLE_CLICK = 2;

public void mouseClicked(MouseEvent event) {
 if (event.getClickCount() == DOUBLE_CLICK) {
 System.exit (0);
 } else {
 //print out mouse click location
 int x, y;

 x = event.getX();
 y = event.getY();

 System.out.println "[" + x + "," + y + "];"
 }
}
```

Because a double-click is a sequence of two single clicks, this method is called twice when you double-click. The getClickCount method returns 1 for the first call and returns 2 for the second call.

Here's the complete program listing:

```

/*
 Chapter 14 Sample Program: Tracks the mouse movement

 File: Ch14TrackMouseFrame.java
*/

import javax.swing.*;
import java.awt.event.*;
import java.io.*;

class Ch14TrackMouseFrame extends JFrame implements MouseListener {

 private static final int FRAME_WIDTH = 450;
 private static final int FRAME_HEIGHT = 300;
 private static final int FRAME_X_ORIGIN = 150;
 private static final int FRAME_Y_ORIGIN = 250;
 private static final int DOUBLE_CLICK = 2;

 //-----
 // Main method
 //-----
 public static void main(String[] args) {
 Ch14TrackMouseFrame frame = new Ch14TrackMouseFrame();
 frame.setVisible(true);
 }

 public Ch14TrackMouseFrame() {
 //set frame properties
 setTitle ("TrackMouseFrame");
 setSize (FRAME_WIDTH, FRAME_HEIGHT);
 setResizable(false);
 setLocation (FRAME_X_ORIGIN, FRAME_Y_ORIGIN);

 setDefaultCloseOperation(EXIT_ON_CLOSE);

 //register self as a mouse event listener
 addMouseListener(this);
 }

 public void mouseClicked(MouseEvent event) {
 if (event.getClickCount() == DOUBLE_CLICK) {
 System.exit(0);
 } else {
 int x, y;

```

```
x = event.getX(); //get the x and y coordinates of
y = event.getY(); //the mouse click point

System.out.println "[" + x + "," + y + ""];
 }
}

public void mouseEntered (MouseEvent event) { }
public void mouseExited (MouseEvent event) { }
public void mousePressed (MouseEvent event) {
 System.out.println("Down");
}

public void mouseReleased(MouseEvent event) {
 System.out.println("Up");
}
}
```

## SketchPad

Let's try another example. The basic idea of this program is to keep track of three events:

1. The left mouse button is pressed down.
2. The right mouse button is pressed down.
3. The mouse is dragged.

Notice that we are processing mouse button presses, not clicks. (*Note:* For the Mac platform, a mouse button press is treated as the left button press, and the Command press is treated as the right button press. For a platform that supports three mouse buttons, the middle mouse button is also treated as the left mouse button.)

To implement this class, we will declare `Ch14SketchPad` to implement two interfaces: `MouseListener` and `MouseMotionListener`. Since we want a `Ch14SketchPad` frame to process mouse button clicks, we must implement the `MouseListener` interface. In addition, we need to implement the `MouseMotionListener` interface to track the mouse dragging. The `MouseMotionListener` interface includes two abstract methods: `mouseDragged` and `mouseMoved`. The argument to both methods is an instance of `MouseEvent`.

When a mouse button, either the left or right button, is pressed, the event listener's `mousePressed` is called. Let's study how we should implement this method. If the right mouse button is pressed, then we have to erase the current drawing. If the left mouse button is pressed, then it is the start of a new mouse drag, so we have to remember the location where the left button is pressed. To determine which

mouse button is pressed inside the `mousePressed` method, we call the `isMetaDown` method of `MouseEvent` as

```
if (event.isMetaDown()) {
 //the right button is pressed
 ...
}
```

The `isMetaDown` method returns true if the right button is pressed. We don't have a method such as `isRightButtonPress` in `MouseEvent` because not all platforms support the right mouse button. The Mac platform, for example, has only one mouse button, and for the Mac, the Command press is treated as the right mouse button press.

The code to erase the contents of the window is

```
if (event.isMetaDown()) {
 //the right button is pressed
 //so erase the contents
 Graphics g = getGraphics();
 Rectangle r = getBounds();
 g.clearRect(0, 0, r.width, r.height);
 g.dispose();
}
```

We erase the contents by drawing a filled rectangle as big as the window itself with the rectangle filled in the background color. The `getBounds` method returns the size of a window.

If it is not a right mouse button press, then it is a left button press, so we remember the first position to draw a line.

```
if (event.isMetaDown()) {
 //the right button is pressed
 ...
} else {
 //remember the starting point of a new mouse drag
 last_x = x;
 last_y = y;
}
```

**last\_x and last\_y**  
are instance  
variables.

The position  $(x, y)$  is computed at the beginning of the `mousePressed` method as

```
int x = event.getX();
int y = event.getY();
```

The `getX` and `getY` methods of the `MouseEvent` class return the  $x$  and  $y$  coordinates, respectively, of the point where the mouse button is pressed.

Now, to process the mouse drag event, we need to define the `mouseDragged` method. From the argument object `MouseEvent`, we get a new position  $(x, y)$  and draw a line from the previous position to this new position, using the `Graphics` object `g` as follows:

```
g.drawLine(last_x, last_y, x, y);
```

After the drawing is done, we reset the variables.

```
last_x = x;
last_y = y;
```

Similar to the `mousePressed` method, the `mouseDragged` method is called whether the mouse was dragged with the left or right button. So we need to include the if test

```
if (!event.isMetaDown()) {
 //it's a left mouse button drag,
 //so draw a line
 ...
}
```

inside the method so the drawing will occur only for the left mouse button drag. Here's a complete listing of the program:

```
/*
Chapter 14 Sample Program: My SketchPad

File: Ch14SketchPad.java
*/

import javax.swing.*;
import java.awt.*;
import java.awt.event.*;

class Ch14SketchPad extends JFrame
 implements MouseListener, MouseMotionListener {

 private static final int FRAME_WIDTH = 450;
 private static final int FRAME_HEIGHT = 300;
 private static final int FRAME_X_ORIGIN = 150;
 private static final int FRAME_Y_ORIGIN = 250;

 private int last_x;
 private int last_y;

 //-----
 // Main method
 //-----
 public static void main(String[] args) {
 Ch14SketchPad frame = new Ch14SketchPad();
 frame.setVisible(true);
 }

 public Ch14SketchPad() {
 //set frame properties
 setTitle ("Chapter 14 SketchPad");
 }
}
```



```

setSize (FRAME_WIDTH, FRAME_HEIGHT);
setResizable(false);
setLocation (FRAME_X_ORIGIN, FRAME_Y_ORIGIN);

setDefaultCloseOperation(EXIT_ON_CLOSE);

last_x = last_y = 0;

addMouseListener(this); //adds itself as mouse and
addMouseMotionListener(this); //mouse motion listener
}

//-----
// Mouse Event Handling
//-----

public void mousePressed(MouseEvent event) {
 int x = event.getX();
 int y = event.getY();

 if (event.isMetaDown()) {
 //the right mouse button is pressed, so erase the contents
 Graphics g = getGraphics();
 Rectangle r = getBounds();
 g.clearRect(0, 0, r.width, r.height);
 g.dispose();
 } else {
 //the left mouse button is pressed,
 //remember the starting point of a new mouse drag
 last_x = x;
 last_y = y;
 }
}

public void mouseClicked (MouseEvent event) { }
public void mouseEntered (MouseEvent event) { }
public void mouseExited (MouseEvent event) { }
public void mouseReleased(MouseEvent event) { }

//-----
// Mouse Motion Event Handling
//-----

public void mouseDragged(MouseEvent event) {
 int x = event.getX();
 int y = event.getY();

 if (!event.isMetaDown()) {
 //don't process the right button drag
 Graphics g = getGraphics();

 g.drawLine(last_x, last_y, x, y);
 g.dispose();
 }
}

```

```

 last_x = x;
 last_y = y;
 }
}

public void mouseMoved (MouseEvent event) { }
}

```



1. Which listener object listens to mouse movements? Which listener object listens to mouse button presses and clicks?
2. What is the purpose of the `isMetaDown` method?
3. What is the difference between `mouseClicked` and `mousePressed`?

## Summary

- The type of user interface covered in this chapter is called a *graphical user interface (GUI)*.
- GUI objects in the `javax.swing` package are collectively called *Swing classes*.
- To program the customized user interface effectively, we must learn a new style of programming control called *event-driven programming*.
- The GUI and related classes and interfaces introduced in this chapter are

ActionEvent	JButton
ActionListener	JCheckBox
BorderFactory	JComboBox
BorderLayout	JFrame
ButtonGroup	JLabel
ChangeEvent	JList
ChangeListener	JMenu
Container	JMenuBar
FlowLayout	JMenuItem
GridLayout	JOptionPane
ImageIcon	JPanel
ItemEvent	JRadioButton
ItemListener	JScrollPane
JTextArea	JSlider
JTextField	MouseListener
MouseEvent	MouseMotionListener

- The `JOptionPane` class is used for a simple GUI input and output.
- GUI objects such as buttons and text fields are placed on the content pane of a frame window.
- The layout manager determines the placement of the GUI objects.
- The `FlowLayout` manager places components in left-to-right, top-to-bottom order.
- The `BorderLayout` manager places components in one of the five regions: north, south, east, west, and center.
- The `GridLayout` manager places components in one of the equal-size  $N \times M$  grids.
- GUI objects can be placed on the content pane without using any layout manager. Such placement is called *absolute positioning*.
- Effective layout of GUI components is achieved by nesting panels and applying different layout managers to the panels.
- `JPanel` is a container for GUI components. `JPanel` itself is a GUI component, and therefore, we can nest `JPanel` objects.
- Event handling is divided into event sources and event listeners. Event sources generate events, and event listeners include a method that gets executed in response to the generated events.
- The most common event type is called an *action event*.
- `ActionListener` handles the action events.
- We use an instance of `JButton` to represent a pushbutton on a frame. `JButton` objects generate action events.
- GUI objects dealing with text are `JLabel`, `JTextField`, and `JTextArea`. The `JTextField` objects generate action events.
- A `JLabel` object can include an image of type `ImageIcon`.
- The `JCheckBox` class is used for check-box buttons. An instance of the class generates action and item events.
- `ItemEvent` is generated when the state (selected/deselected) of an item changes.
- `ItemEvent` is handled by an instance of a class that implements the `ItemListener` interface.
- The `JRadioButton` class is used for radio buttons. An instance of the class generates action and item events.
- The `JComboBox` class is used for combo boxes, also known as drop-down lists. An instance of the class generates action and item events.
- The `JList` class is used for displaying a list of items. (*Note:* A `JList` object generates action and list events. To keep the examples brief and at the introductory level, we did not give any sample code that deals with events generated by a `JList` object.)

- The `JSlider` class is used for sliders. An instance of the class generates change events.
- `ChangeEvent` is handled by an instance of a class that implements the `ChangeListener` interface.
- We can find out the class to which an object belongs by using the `instanceof` operator.
- A frame has one `JMenuBar` object. A single `JMenuBar` can have many `JMenu` objects with many `JMenuItem` objects associated to a single `JMenu` object.
- `JMenuItem` objects generate action events.
- User actions such as moving or dragging the mouse and clicking the mouse buttons will result in the generation of mouse events.
- `MouseListener` handles the button actions, and `MouseMotionListener` handles the mouse movements.

## Key Concepts

graphical user interface	mouse listeners
Swing classes	item events
content pane	item listeners
absolute positioning	change events
events	change listeners
event-driven programming	layout managers
event sources	nested panels
event listeners	radio and check-box buttons
<code>instanceof</code> operator	combo boxes (drop-down lists)
buttons	lists
menus	sliders
mouse events	

## Chapter 14 Exercises

### Level 1 Programming Exercises ★

1. Write a program that inputs three integers and outputs their sum. Use the `JOptionPane` class for both input and output routines.
2. Define a subclass of `JFrame` and name it `Ch14MuFrame`. Set the subclass so its instances will be 400 pixels wide and 450 pixels high and will have a blue background. The program terminates when the Close box is clicked.

3. Define a JFrame subclass with one pushbutton. When a button is clicked, display the message You clicked! using JOptionPane. Closing the frame window terminates the program.
4. Define a JFrame subclass with one pushbutton and one text field. When a button is clicked, change the title of the frame window to the text in the text field. Closing the frame window terminates the program.
5. Modify the Ch14SketchPad program so it will terminate when the left button of the mouse is double-clicked. You achieve this by defining an appropriate method body for the mouseClicked method.

### Level 2 Programming Exercises ★★

6. Define a JFrame subclass that has one pushbutton. Initially, the background color is white (Color.WHITE) and the button's text is ON. When the button is clicked, the background of the frame changes to yellow (Color.YELLOW) and the text of the button changes to OFF. If the button is clicked again, the frame returns to the initial state (ON button text and white background color). Because the button text switches back and forth between ON and OFF, such button is called a *toggle switch*. Closing the frame window terminates the program.
7. Define a JFrame subclass that has four vertically positioned buttons. The labels for the four buttons are Senior, Junior, Sophomore, and Freshman. This is one possible layout:

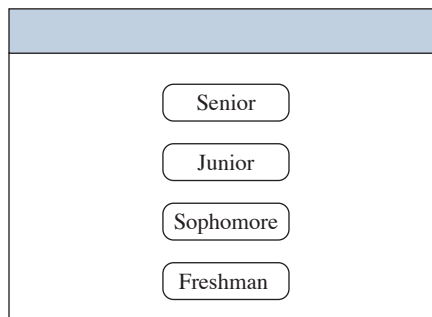

When a button is clicked, display a message that identifies which button is clicked, using JOptionPane.

8. In the Ch14TextFrame1 class, event handling was done with this class. Modify the class so the button events are handled by a ButtonHandler and the text events are handled by a TextHandler. You can use the ButtonHandler class defined in the chapter, but you need to define your own TextHandler class.
9. A slugging percentage of a baseball player is computed by dividing the total bases of all hits by the total times at bat (single = 1 base, double = 2 bases, triple = 3 bases, and home run = 4 bases). Write an application that

computes the slugging percentage. Create a customized frame and use `TextField` objects to accept five input values: number of singles, number of doubles, number of triples, number of home runs, and number of times at bat. When the user clicks the Compute button, display the slugging percentage, using `JLabel`.

- Write an application that draws a circle every time the mouse button is clicked. The position where the mouse is clicked will become the center of the circle. Set the radius of the circle to 100 pixels.

### Level 3 Programming Exercises ★★★

- Using the frame layout shown, write a program that displays  $N$  prime numbers, where  $N$  is a value entered in the text field. A *prime number* is an integer greater than 1 and divisible by only itself and 1.

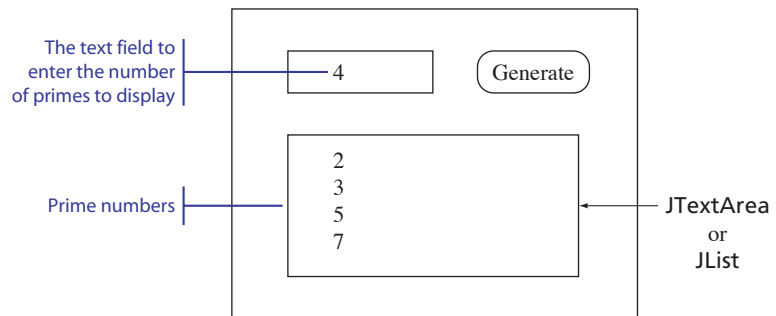

- Define an `OutputBox` class as a subclass of `JFrame`. The `OutputBox` class provides the functionality of `System.out` (`PrintStream`) by supporting these methods:

```
public void println(String line)
public void print(String text)
```

The `OutputBox` class contains one `JTextArea` object. Do not use absolute positioning. Use the default layout and add a `JScrollPane` that wraps the `JTextArea` object to the content pane.

- Redo Exercise 10 in Chapter 6, but this time use the `OutputBox` class created in Exercise 12 for output.
- Write a graphical user interface for the slot machine program in Exercise 32 in Chapter 6. Use three `JLabel` objects for displaying bells, grapes, and cherries. Add a button that simulates the motion of pulling down the handle.
- Add images to the Exercise 14 solution. Create three gif files, one each for the bell, grape, and cherry. Use `JLabel` objects with `ImageIcon` to display these images on the frame.

16. Write a `MyMenuFrame` class with these menu choices.

File	Edit	Color
Quit	Erase	Red Green Blue Pink Black

When the user selects `Quit`, stop the program. When the user selects one of the colors, change the background of the frame (i.e., change the background color of the frame's content pane) to the selected color. When the user selects `Erase`, reset the background color to white.

17. Write a program that draws a selected geometric shape in random color and at a random location. The menu choices for the program are

Shape
Circle Rectangle Square

18. Extend Exercise 10 by adding the following menu to let the user select the shape to draw every time the mouse button is clicked. The clicked point will be the center of the selected shape. Choose appropriate values for the dimensions of the three shapes.

Shape
Circle Rectangle Square

19. Rewrite the `Ch14TicTacToePanel` class by using the approach illustrated in Figure 14.21.
20. Modify the `Ch14SliderExample` program by adding three text fields, one per slider. Place these text fields under the sliders. When the slider value is changed, display the slider value in the corresponding text field. The user can see the precise RGB values from these text fields. Allow the user to modify the RGB values by entering the values in the text fields. When the value in a text field is changed, adjust the corresponding slider's position accordingly.

## Development Exercises

For Exercises 21 through 34, use the incremental development methodology to implement the program. Design a visually appealing GUI with Swing components and layout managers. For each exercise, identify the program tasks, create a design document with class descriptions, and draw the program diagram. Map out the development steps at the start. Present any design alternatives and justify your selection. Be sure to perform adequate testing at the end of each development step.

- Write a `TeachArithmeticFrame` class that teaches children arithmetic. The frame uses a `JLabel` for a problem and a `JTextField` for the user answer. When the user presses the Enter key (while the `JTextField` object is active) or clicks the OK button, display a message stating whether the user's answer is correct. When the Next button is clicked, display a new problem. The numbers are limited to two digits.

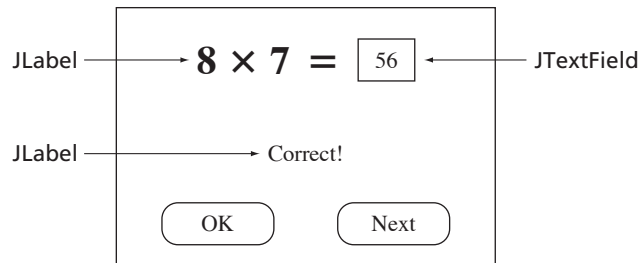

Consider using a larger font for the `JLabel` and `JTextField` text. You can change the color of text by calling the `setForeground` method, for example.

```
questionLbl.setForeground(Color.RED);
```

Define a helper class that generates problems.

- Extend the `TeachArithmeticFrame` class so that the numbers of correct and incorrect answers are kept. Display these two numbers somewhere on the frame. Add the third button labeled Reset. When this button is clicked, the counters for correct and incorrect answers are reset to zero.
- Modify the mortgage table program of Exercise 30 in Chapter 6. Add this menu

File	Help
New Table Quit	About...



to the program. When the user selects the menu choice **New Table**, the program opens another frame in which the user can enter three input values. The input frame should look something like this:

The diagram shows a rectangular frame containing three vertically stacked text input fields. Each field is preceded by a label: 'Loan Amount:', 'Interest Rate:', and 'Loan Period:'. Below the input fields are two rounded rectangular buttons labeled 'Cancel' and 'Compute'.

If the user clicks on the **Compute** button and the three input values are valid, generate a mortgage table. Use the `OutputBox` class from Exercise 12 to display the mortgage table. If the input values are invalid, then print out an appropriate error message. Decide on the range of valid values for the loan amount, interest rate, and loan period. When the user selects the menu choice **About . . .**, describe the purpose of the program by using another frame. You should create only one input frame, but may decide to use more than one `OutputBox` frame so you can see multiple loan tables at once.

24. Redo Exercise 23 with a new user interface. The left side of a frame is used to enter the loan amount, interest rate, and loan period. The right side of a frame displays the mortgage table for given input values. The following layout is merely a suggestion. Feel free to use other GUI components as you see fit. For example, consider using `JComboBox` for entering interest rates and loan periods.

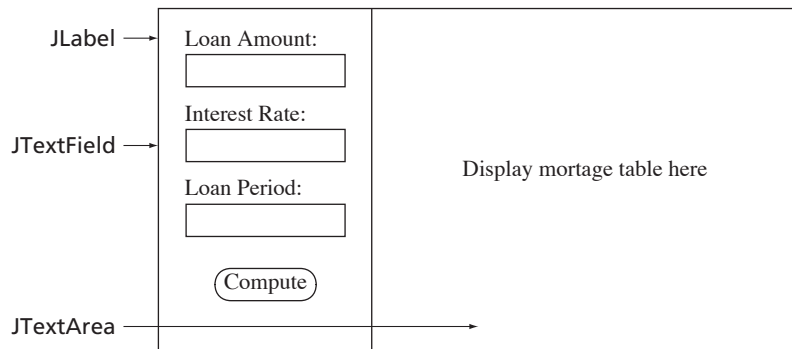

25. (Challenge) Write a class that implements a calculator with the layout similar to this:

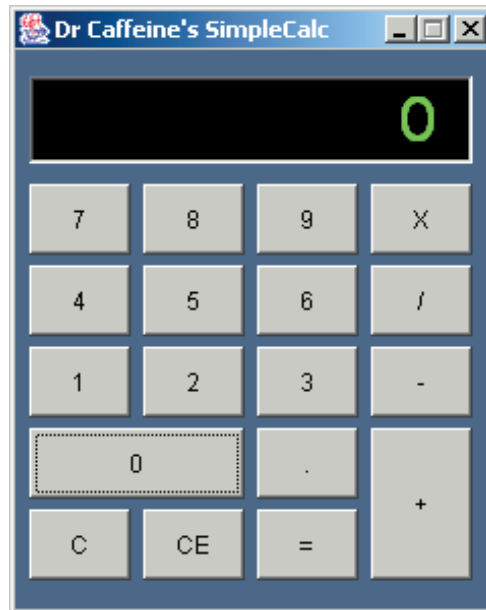

The user enters a number, using digit buttons only. Some of the issues you need to consider include

- How to determine whether the user is entering a left operand or a right operand.
- How to handle the entering of multiple decimal points. A typical calculator accepts the first decimal point and ignores the rest. For example, if you press  $1.4.3.$ , the number entered is 1.43.
- When the display is 0 and the user enters 0, the display will not change. However, if the display is nonzero and the user enters 0, the 0 is appended to the number currently displayed.
- How to handle the operator precedence. For example, what will be the result if the user enters  $4 + 3 \times 2$ ? Will it be 14 or 10? It is easier to treat all operators as having equal precedence and process them from left to right.

Study any real four-function calculator and try to implement a software calculator that simulates the real calculator as faithfully as possible, but feel free to make any reasonable changes.

26. Extend the calculator of Exercise 25 to allow the user to enter a number by using the keyboard. The class needs to implement the `KeyListener` interface and define the `keyTyped` method. You have to find information on `KeyListener` and `KeyEvent` from a Java API reference manual.

27. Latte Gallery in Carmel, California, is a small gallery that specializes in selling contemporary fine art, especially lithographs and photographs. All items sold in the gallery are signed and numbered. Write an application that keeps track of
- Customers and their art purchases.
  - Artists and their works that have appeared in the gallery.
  - Current inventory.

Allow the user to add, delete, or modify the customer, artist, and artwork information. An inventory will include the purchase price of the artwork and the selling price when sold. Give the user an option to list all customers or one customer. The user will specify the customer to display by entering the customer's last name and phone number.

Define at least four data members for each type of information. For customers, include the name, phone number, address, and artwork and artist preferences. For artists, include the name, speciality, whether alive or deceased, and price ranges of artwork. For artwork, include the title, date purchased, date sold, and artist. Feel free to add more data members as you see fit.

Design appropriate GUI for entering and editing customers, artists, and artwork.

28. Improve the Latte Gallery information manager application by adding the following capabilities:
- List all customers who bought artwork by a given artist.
  - List all artists who are still alive (so you can buy their artwork while the price is still reasonable).
  - List all artwork in the inventory that did not sell for over 3 months. (This requires the use of the `Date` class from the `java.util` package.)

Adjust the GUI accordingly.

29. Improve the Latte Gallery information manager application by adding a feature that allows the user to select a customer from the list of all customers by clicking on the customer that he or she wants to see. The listing of all customers will include their names. When the user clicks on a name, the full information of the selected customer will appear on the right side of the frame.

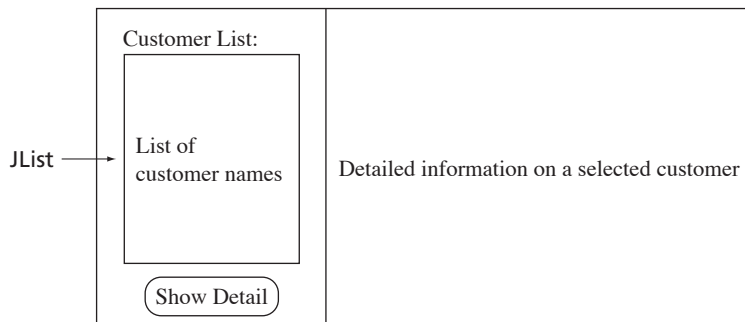

30. Write a program that plays the game of Fermi. The program generates three distinct random digits between 0 and 9. These digits are assigned to positions 1, 2, and 3. The goal of the game is for the player to guess the digits in three positions correctly in the least number of tries. For each guess, the player provides three digits for positions 1, 2, and 3. The program replies with a hint consisting of Fermi, Pico, or Nano. If the digit guessed for a given position is correct, then the reply is Fermi. If the digit guessed for a given position is in a different position, the reply is Pico. If the digit guessed for a given position does not match any of the three digits, then the reply is Nano. Here are sample replies for the three secret digits 6, 5, and 8 at positions 1, 2, and 3, respectively.

Guess	Hint	Explanation
1 2 5	Nano Nano Pico	The value 5 matches but at the wrong position.
8 5 3	Pico Fermi Nano	The value 5 matches at the correct position. The value 8 matches but at the wrong position.
5 8 6	Pico Pico Pico	All match at the wrong positions.

Notice that if the hints like the above are given, the player can tell which number did not match. For example, given the hint for the second guess, we can tell that 3 is not one of the secret numbers. To avoid this, provide hints in a random order or in alphabetical order (e.g., it will be Fermi Nano Pico instead of Pico Fermi Nano for the second reply). Implement the program with an attractive and elegant GUI.

31. Extend the Fermi playing program by allowing the player to
- Select the number of secret digits.
  - Select alphabets instead of digits.
  - Include duplicate secret digits.

Adjust the GUI accordingly.

32. Write a personal scheduler application. Each entry in the scheduler is an appointment, a to-do item, or a memo. Each entry has the date and the time it is entered. An entry can be locked, and if it is locked, the user cannot modify it. For an appointment entry, include the person and the place of meeting. For a to-do entry, include a short description of a task and the due date. For a memo, include a text. Implement the program with an attractive and elegant GUI.
33. Write a rental point-tracking system for an up-and-coming Espresso's Dynamo Mopeds in Monterey, California. To compete against Ms. Latte's Mopeds R Us, Espresso's Dynamo Mopeds decided to install an automated point-tracking system. When a customer first rents a moped, his or her information is entered into a database. For each rental, a customer receives points, and when the total points reach 100, the customer can rent a moped

free for 3 hours or redeem a free movie rental coupon from Espresso's Majestic Movies. The points are earned in the following scheme:

Renter	Type	Points
College student	50cc Moppi	15
	150cc Magnum	20
Adult	50cc Moppi	10
	150cc Magnum	15
Senior	50cc Moppi	20
	150cc Magnum	30

In addition to the basic operations of updating the point information for every rental, include an operation to list all customers who earned over 100 points. Also, support an operation to edit the customer information. Implement the program with an attractive and elegant GUI.

34. Update the rental point-tracking system to support a new rental system and point-awarding rules for Espresso's Dynamo Mopeds. Now the customers can rent only on an hourly basis, and the points are awarded accordingly. Upon rental, the customer will state the number of hours he or she will rent in increments of 1 hour with a maximum of 10 hours. The rental fee is based on the following formula:

Renter	Type	Total Rental ≤ 5 hours	Total Rental > 5 hours
College student	50cc Moppi	\$3.50 per hour	\$2.50 per hour
	150cc Magnum	\$4.50 per hour	\$3.50 per hour
Adult	50cc Moppi	\$5.00 per hour	\$4.00 per hour
	150cc Magnum	\$6.50 per hour	\$5.00 per hour
Senior	50cc Moppi	\$4.00 per hour	\$3.00 per hour
	150cc Magnum	\$5.25 per hour	\$4.00 per hour

# Recursive Algorithms

# 15

## O b j e c t i v e s

---

*After you have read and studied this chapter, you should be able to*

- Write recursive algorithms for mathematical functions and nonnumerical operations.
- Decide when to use recursion and when not to.
- Describe the recursive quicksort algorithm and explain how its performance is better than that of selection and bubble sort algorithms.

## Introduction



# W

e introduced recursion in Chapter 6 and showed how to write recursive methods to implement mathematical functions. We used mathematical functions in Chapter 6 because it is easier to see how the recursion works with mathematical functions. However, recursive methods are not limited to implementing mathematical functions, and we will present several nonnumerical recursive algorithms in this chapter. We will also discuss some criteria for deciding when to use recursion and when not to. All the recursive algorithms we provide in this chapter, other than those we use for explanation, are algorithms that should be written recursively.

## 15.1 Basic Elements of Recursion

recursive  
method

A *recursive method* is a method that contains a statement (or statements) that makes a call to itself. In Chapter 6, we implemented three mathematical functions using recursion. In this chapter, we will present recursive algorithms for nonnumerical operations. But before we introduce new examples, let's review one of the recursive algorithms we presented in Chapter 6.

The *factorial* of  $N$  is the product of the first  $N$  positive integers, denoted mathematically as

$$N! = N * (N-1) * (N-2) * \dots * 2 * 1$$

We can define the factorial of  $N$  recursively as

$$\text{factorial}(N) = \begin{cases} 1 & \text{if } N = 1 \\ N * \text{factorial}(N-1) & \text{otherwise} \end{cases}$$

We mentioned in Chapter 6 that any recursive method will include the following three basic elements:

1. A test to stop or continue the recursion.
2. An end case that terminates the recursion.
3. A recursive call(s) that continues the recursion.

These three elements are included in the following recursive factorial method.

```
public int factorial(int N)
{
 if (N == 1) { ← Test to stop or continue.
 return 1; ← End case: recursion stops.
 }
}
```

```

else {
 return N * factorial(N-1);
}
}

```

Recursive case: recursion continues with a recursive call.

## 15.2 | Directory Listing

Let's try some recursive algorithms for nonnumerical applications. A first nonnumerical recursive algorithm will list the filename of all files in a given directory (or folder) of a hard disk and its subdirectories. We will use a `File` object from the `java.io` package to implement the method. Assuming a Windows platform, we create a `File` object by passing the name of a file or a directory, as in

```
File file = new File("C:/Java/Projects");
```

Notice that we pass the full path name. If a `File` object represents a directory, then the boolean method `isDirectory` returns true. To get an array of names of files and subdirectories in a directory, we use the `list` method.

```
String[] fileList = file.list();
```

Let's call the method `directoryListing`. The argument to the method will be a `File` object that represents a directory. The basic idea can be expressed as follows:

```

public void directoryListing(File dir) {
 //assumption: dir represents a directory
 fileList = an array of names of files and
 subdirectories in the directory dir;
 for (each element in fileList) {
 if (an element is a file) {
 output the element's filename; //end case: it's
 //a file.
 } else { //recursive case: it's a directory
 call directoryListing with element as
 an argument;
 }
 }
}

```

The complete method is as follows:

```

public void directoryListing(File dir) {
 //assumption: dir represents a directory
 String[] fileList = dir.list(); //get the contents
 String dirPath = dir.getAbsolutePath();
}

```



```

 for (int i = 0; i < fileList.length; i++) {
 File file = new File(dirPath + "/" + fileList[i]);
Test → if (file.isFile()) { //it's a file
End case → System.out.println(file.getName());
 } else {
Recursive case → directoryListing(file); //it's a directory
 //so make a recursive call
 }
 }
 }
}

```

Notice the argument we pass to create a new File object inside the for loop is

```
File file = new File(dirPath + File.separator
 + fileList[i]);
```

where dirPath is set as

```
String dirPath = dir.getAbsolutePath();
```

and File.separator is a class constant for the system-dependent character used as the file separator.

The getAbsolutePath method returns the full path name for the directory, and we need to prepend it to the name (fileList[i]) of a file or a subdirectory in this directory in order to make the testing

```
if (file.isFile()) ...
```

work correctly.

To give you more practice in reading recursive methods, we will remove the assumption that the argument File represents a directory and rewrite the method. If the argument File object to directoryListing can be either a file or a directory, then we need to check this first. If the argument object is a file, then we list its filename and stop the recursion. If the argument object is a directory, then we get the list of contents in the directory and make recursive calls. Here's the second version:

```

public void directoryListing(File file) {
 //'file' may be a directory or a file

 String[] fileList;
 String pathname = file.getAbsolutePath();

Test → if (file.isFile()) {
End case → System.out.println(file.getName()); //it's a file so
//print it out
 } else { //it's a directory, so make a recursive call

```

```

fileList = file.list();
for (int i = 0; i < fileList.length; i++) {
 File nextFile = new File(pathname+ File.separator
 + fileList[i]);
 directoryListing(nextFile); //recursive call
}
}
}

```

Recursive case →

## 15.3 | Anagram

anagram

Our second example of a nonnumerical recursive method is to derive all anagrams of a given word. An *anagram* is a word or phrase formed by reordering the letters of another word or phrase. If the word is CAT, for example, then its anagrams are

Word → C A T  
 C T A  
 A T C  
 A C T  
 T C A  
 T A C

← Anagrams

Figure 15.1 illustrates the basic idea of using recursion to list all anagrams of a word.

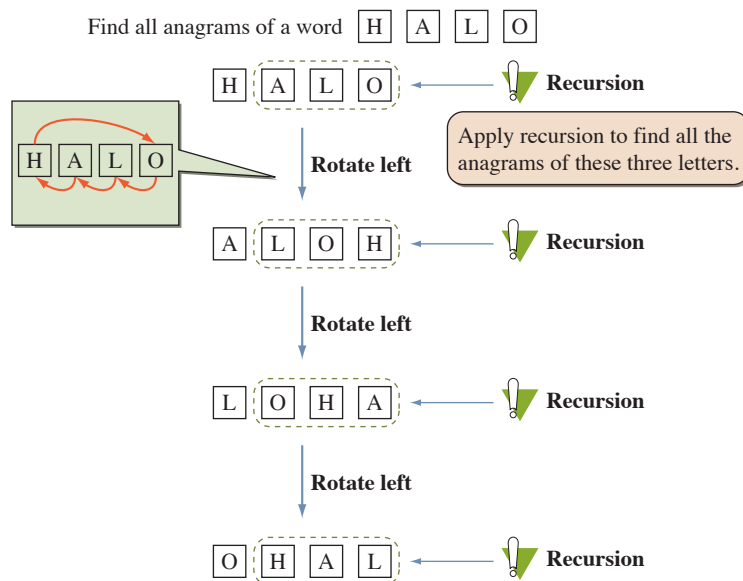

**Figure 15.1** How to generate all the anagrams of a word by using recursion.

Expressing the basic idea, we have something like this:

```
public void anagram(String word) {
 int numOfChars = word.length();

 if (numOfChars == 1) {
 //End case: there's only one character left,
 // so we can't make a recursive call
 } else {
 for (int i = 1; i <= numOfChars; i++) {

 char firstLetter = word.charAt(0);

 suffix = word.substring(1, numOfChars);

 anagram(suffix); //make a recursive call
 //with the remaining
 //letters in the word

 //rotate left
 word = suffix + firstLetter;
 }
 }
}
```

Figure 15.1  
illustrates the  
logic of this for  
loop.

To derive the real method that executes correctly, we must finalize a number of things. First, what will we do when the recursion stops? Hitting upon the end case means that we have found one anagram, so we will print it out. Now, this is the tricky part. When we call the method recursively, we are passing a word that has the first letter chopped off. This means the words being passed to successive recursive calls are getting shorter and shorter. But we need to access all letters in a word to print it out. We can solve this problem by passing two parameters: the prefix and the suffix of a word. In each successive call, the prefix becomes one letter more and the suffix becomes one letter less. When the suffix becomes one letter only, then the recursion stops. Using this idea, we see the method now looks like this:

```
public void anagram(String prefix, String suffix) {
 int numOfChars = suffix.length();

 if (numOfChars == 1) {
 //End case: print out one anagram
 System.out.println(prefix + suffix);
 } else {
 ...
 }
}
```

and this method is initially set with an empty prefix and the word being the suffix, as in

```
anagram("", "HALO");
```

Now, by using the two parameters prefix and suffix, the for loop is written as

```
for (int i = 1; i <= numOfChars; i++) {
 newSuffix = suffix.substring(1, numOfChars);
 newPrefix = prefix + suffix.charAt(0);

 anagram(newPrefix, newSuffix); //recursive case

 //rotate left to create a rearranged suffix
 suffix = newSuffix + suffix.charAt(0);
}
```

Putting everything together, we have the final anagram method:

```
public void anagram(String prefix, String suffix) {
 String newPrefix, newSuffix;
 int numOfChars = suffix.length();

 Test → if (numOfChars == 1) {
 //End case: print out one anagram
 End case → System.out.println(prefix + suffix);
 } else {
 Recursive case → for (int i = 1; i <= numOfChars; i++) {
 newSuffix = suffix.substring(1, numOfChars);
 newPrefix = prefix + suffix.charAt(0);

 anagram(newPrefix, newSuffix);
 //recursive call

 //rotate left to create a rearranged suffix
 suffix = newSuffix + suffix.charAt(0);
 }
 }
}
```

Because the ending condition for recursion is tricky, let's study carefully the test to stop the recursion. We set the test to

```
if (numOfChars == 1) ...
```

Is there any assumption we must make about the parameters so that this method will work correctly? We mentioned earlier that the initial call to the recursive method is something like

```
anagram("", "HALO");
```

What would happen if we made the call initially like

```
String str = inputBox.getString();
anagram("", str);
```

and the user entered an empty string? This is left as Exercise 2.



1. Determine the output of these calls without actually running the method.

- a. `anagram("", "DOG");`
- b. `anagram("", "CAFE");`

## 15.4 Towers of Hanoi

The objective of a puzzle called the *Towers of Hanoi* is deceptively simple, but finding a solution is another matter. The goal of the puzzle is to move  $N$  disks from peg 1 to peg 3 by moving one disk at a time and never placing a larger disk on top of a smaller disk. See Figure 15.2.

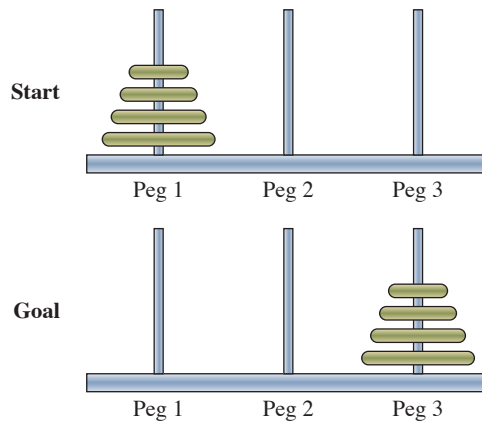

**Figure 15.2** Towers of Hanoi with  $N = 4$  disks.

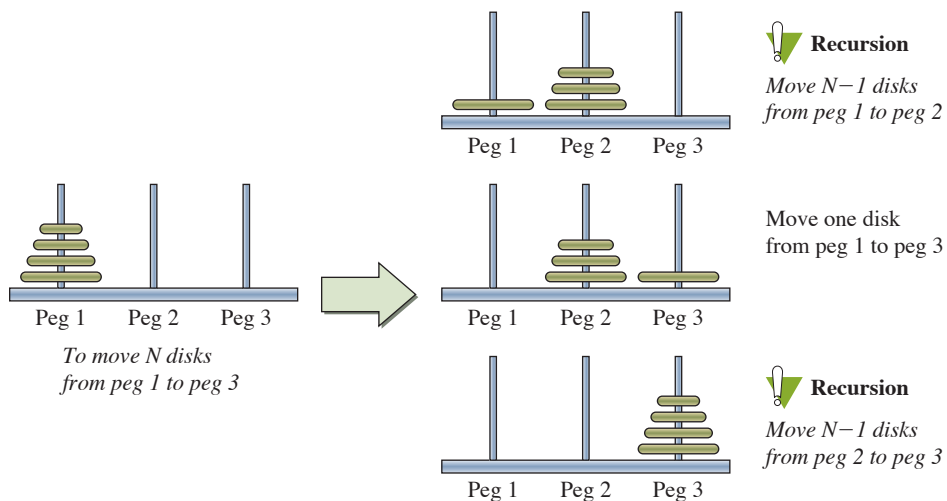

**Figure 15.3** Recursive solution to the Towers of Hanoi puzzle.

The Towers of Hanoi puzzle can be solved very nicely by using recursion. The Aha! moment to this puzzle occurs when you realize that you can solve the puzzle if somehow you can move the top  $N - 1$  disks to peg 2. After the top  $N - 1$  disks are moved to peg 2 temporarily, you move the largest disk from peg 1 to peg 3 and finally move the  $N - 1$  disks from peg 2 to peg 3. Figure 15.3 illustrates these three steps. The first and the third steps are, of course, the same puzzle with one fewer disk and the destination peg changed. So you apply the same logic recursively to the first and third steps. When the number of disks becomes 1, then the recursion stops. Applying this recursive thinking, we can write the method as

```
public void towersOfHanoi(int N, //number of disks
 int from, //origin peg
 int to, //destination peg
 int spare) //"middle" peg
{
 if (N == 1) {
 moveOne(from, to);
 } else {
 towersOfHanoi(N-1, from, spare, to);

 moveOne(from, to);

 towersOfHanoi(N-1, spare, to, from);
 }
}
```

The moveOne is the method that actually moves the disk. Here we will define the method to print out the move, using System.out.

```
private void moveOne(int from, int to) {
 System.out.println(from + " ---> " + to);
}
```

When we run this method with  $N = 4$ , we get the following output:

```
1 ---> 2
1 ---> 3
2 ---> 3
1 ---> 2
3 ---> 1
3 ---> 2
1 ---> 2
1 ---> 3
2 ---> 3
2 ---> 1
3 ---> 1
2 ---> 3
1 ---> 2
1 ---> 3
2 ---> 3
```

The output is very difficult to read. We can improve the output considerably by padding a varying number of blank spaces to show the level of recursion. We can change the output to

```

1 ---> 2
1 ---> 3
2 ---> 3
1 ---> 2
3 ---> 1
3 ---> 2
1 ---> 2
1 ---> 3
2 ---> 3
2 ---> 1
3 ---> 1
2 ---> 3
1 ---> 2
1 ---> 3
2 ---> 3

```

← These steps are for moving 3 disks from peg 1 to peg 2.

by rewriting the methods as follows:

```

public void towersOfHanoi(int N, //number of disks
 int from, //origin peg
 int to, //destination peg
 int spare, //"middle" peg
 int indent)//# of leading spaces
{
 if (N == 1) {
 moveOne(from, to, indent);
 } else {
 towersOfHanoi(N-1, from, spare, to, indent+2);

 moveOne(from, to, indent+2);

 towersOfHanoi(N-1, spare, to, from, indent+2);
 }
}

private void moveOne(int from, int to, int indent) {
 System.out.format("%" + (indent+8) + "s\n",
 from + " ---> " + to);
}

```

## 15.5 | Quicksort

We will present a sorting algorithm that uses recursion in this section. This sorting algorithm is called *quicksort*, and we will compare the performance of quicksort against that of the previous two sorting algorithms at the end of this section, to verify that quicksort deserves its name.

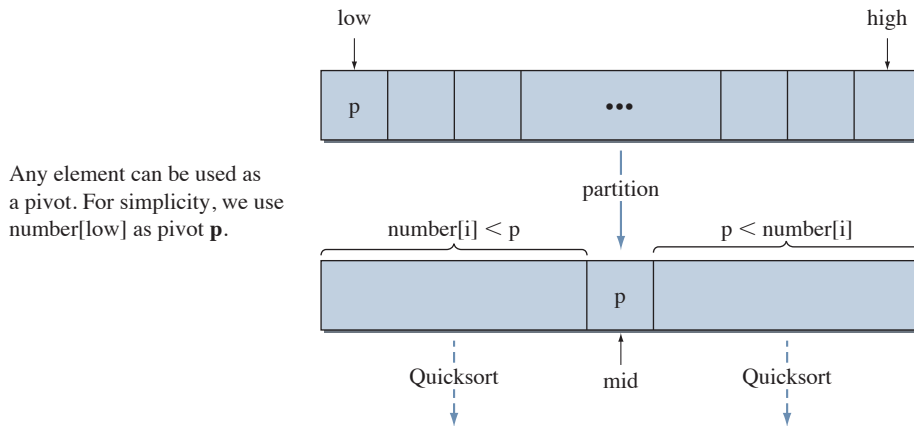

**Figure 15.4** The core idea of the quicksort algorithm.

Figure 15.4 illustrates the core thinking of quicksort. To sort an array from index `low` to `high`, we first select a pivot element `p`. We can select any element in the array as a pivot, but for simplicity, we choose `number[low]` as the pivot. Using `p` as the pivot, we scan through the array and move all elements smaller than `p` to the lower half (left half in the figure) and all elements larger than `p` to the upper half. Then we sort the lower and upper halves recursively, using quicksort. The variable `mid` points to the position where the pivot is placed. So the lower half of the array is from index `low` to `mid-1`, and the upper half of the array is from index `mid+1` to `high`. The recursion stops when the condition `low >= high` becomes true.

Here's the quicksort algorithm:

```
public void quickSort(int[] number, int low, int high) {
 if (low < high) {
 int mid = partition(number, low, high);
 quickSort(number, low, mid-1);
 quickSort(number, mid+1, high);
 }
}
```

The `partition` method splits the array elements `number[low]` to `number[high]` into two halves, as shown in Figure 15.4. We use `number[low]` as the pivot element. The method returns the position where the pivot element is placed. Figure 15.5 shows the result of partitioning the array by using the element 23 as a pivot.

We first set the pivot to `number[low]`. Then we start looking for a number smaller than the pivot from position `high`, `high-1`, and so forth. Let's say the number is found at position `J`. Since this number is smaller than the pivot, we move it to position `low`. Now we start looking for a number larger than the pivot from `low+1`, `low+2`, and so forth. Let's say the number is found at position `I`. We move it to position `J`. We then repeat the process, this time looking for a number smaller than the pivot from `J-1`, `J-2`, and so forth. Figure 15.6 shows the details of the partitioning process.



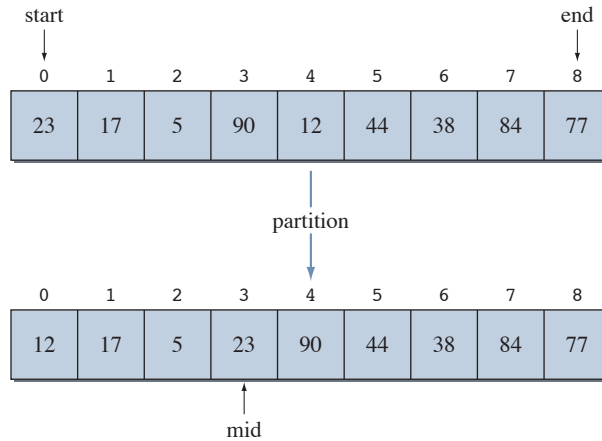

**Figure 15.5** Result of partitioning using 23 as a pivot.

Here's the partition method:

```
private int partition(int[] number, int start, int end) {
 //set the pivot
 int pivot = number[start];

 do {
 //look for a number smaller than pivot from the end
 while (start < end && number[end] >= pivot) {
 end--;
 }

 if (start < end) { //found a smaller number
 number[start] = number[end];

 //now find a number larger than pivot
 //from the start
 while (start < end && number[start] <= pivot) {
 start++;
 }

 if (start < end) { //found a larger number
 number[end] = number[start];
 }
 }
 } while (start < end);

 //done, move the pivot back to the array
 number[start] = pivot;

 return start;
}
```

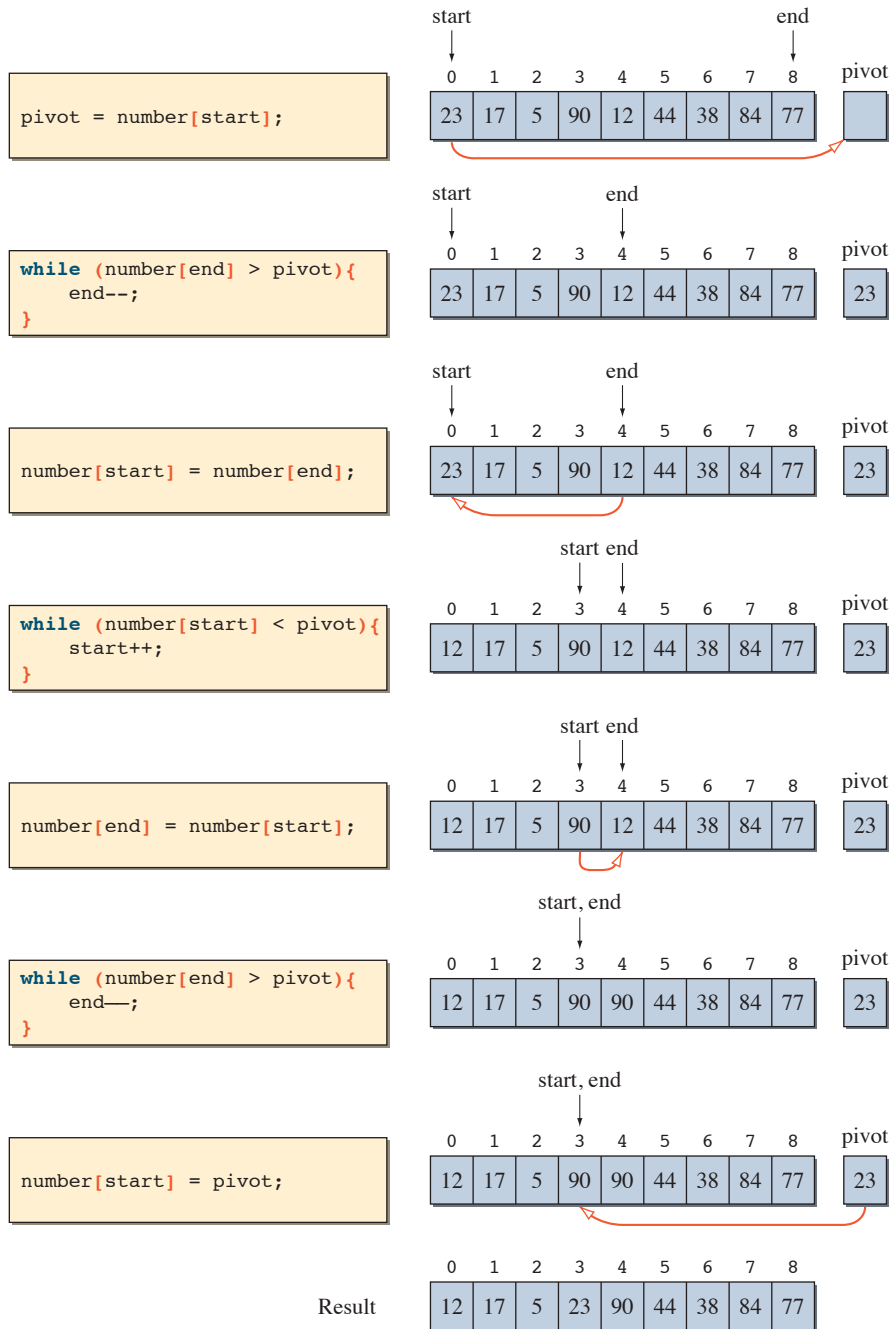

**Figure 15.6** Details of one partitioning.

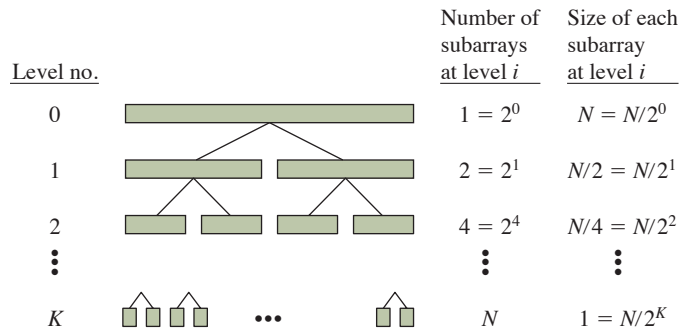

**Figure 15.7** A hierarchy of partitioning an array into smaller and smaller arrays in the quicksort.

How good is quicksort? Does the algorithm execute a fewer number of comparisons than the selection or bubble sort? The answer is no in the worst case. Quicksort executes roughly the same number of comparisons as the selection sort and bubble sort in the worst case. When the original list is either already sorted or in descending order, then after a partition process, either the lower half or the upper half has  $N - 1$  elements. The effect is the same as that of the previous two sorting algorithms; that is, either the smallest or the largest number moves to its correct position. The worst situation can be improved somewhat if we select the median of three numbers, say,  $\text{number}[\text{low}]$ ,  $\text{number}[\text{high}]$ , and  $\text{number}[(\text{low}+\text{high})/2]$ , as the pivot element. Even with this improvement, the number of comparisons in the worst case is still approximately the square of the size of the array.

Is the name quicksort a kind of false advertisement? Not really. On average, we can expect a partition process to split the array into two subarrays of roughly equal size. Figure 15.7 shows how the original array is partitioned into smaller subarrays. When the size of all subarrays becomes 1, then the array becomes sorted. At level  $i$ , there are  $2^i$  subarrays of size  $N/2^i$ . So there will be  $N/2^i$  partition processes at level  $i$ . The total number of comparisons of all those partition processes at level  $i$  is therefore  $2^i \cdot N/2^i = N$ . Since there are  $K$  levels, the total number of comparisons for sorting the whole array is

$$K \cdot N$$

but

$$N = 2^K$$

$$\log_2 N = K$$

so

$$KN = N \log_2 N$$

The total number of comparisons is proportional to  $N \log_2 N$ , which is a great improvement over  $N^2$ . A more rigorous mathematical analysis will show that the quicksort on average requires approximately  $2N \log_2 N$  comparisons.

**Quick  
CHECK**



1. Partition the following arrays, using the partition method.

a.

0	1	2	3	4	5	6	7	8
18	19	5	77	12	14	13	84	45

b.

0	1	2	3	4	5	6	7	8
98	19	15	86	12	44	13	24	45

## 15.6 | When Not to Use Recursion

Recursion is a powerful tool to express complex algorithms succinctly. For example, writing a nonrecursive algorithm for the Towers of Hanoi is unexpectedly difficult. Likewise, a recursive quicksort algorithm is easier to understand than its nonrecursive counterpart. For both problems, we prefer recursive algorithms because recursion is the most natural way to express their solution. However, just being natural is not the criterion for selecting a recursive solution over a nonrecursive one.

Consider a solution for computing the  $N$ th Fibonacci number. A Fibonacci number is defined recursively as

$$\text{fibonacci}(N) = \begin{cases} 1 & \text{if } N = 0 \text{ or } N = 1 \\ \text{fibonacci}(N-1) \\ + \text{fibonacci}(N-2) & \text{otherwise} \end{cases}$$

Because the function is defined recursively, it is natural to implement the function by using a recursive method.

```
public int fibonacci(int N) {
 if (N == 0 || N == 1) {
 return 1; //end case
 } else { //recursive case
 return fibonacci(N-1) + fibonacci(N-2);
 }
}
```

This recursive method is succinct, easy to understand, and elegant. But is this the way to implement it? The answer is no, because the recursive method is grossly inefficient and a nonrecursive version is just as easy to understand. The method is inefficient because the same value is computed over and over. Figure 15.8 shows the recursive calls for computing the fifth Fibonacci number. Notice that the same value, for example, `fibonacci(2)`, is computed repeatedly.

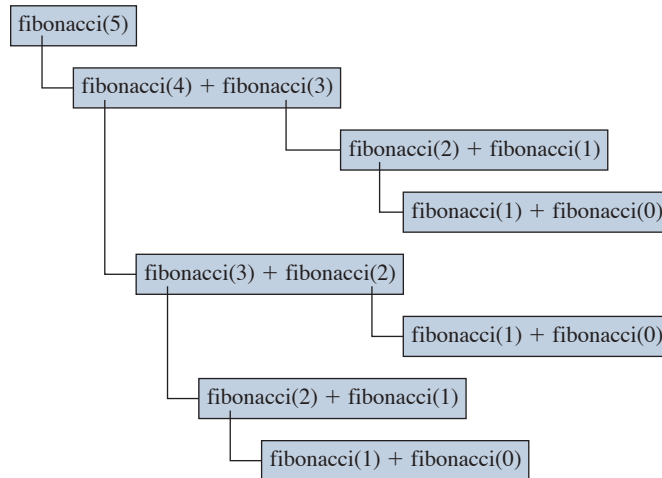

**Figure 15.8** Recursive calls to compute **fibonacci(5)**.

The  $N$ th Fibonacci number can be computed by using a nonrecursive method.

```

public int fibonacci(int N) {
 int fibN, fibN1, fibN2, cnt;

 if (N == 0 || N == 1) {
 return 1;
 } else {
 fibN1 = fibN2 = 1;
 cnt = 2;

 while (cnt <= N) {
 fibN = fibN1 + fibN2; //get the next fib no.

 fibN1 = fibN2;
 fibN2 = fibN;

 cnt ++;
 }
 return fibN;
 }
}

```

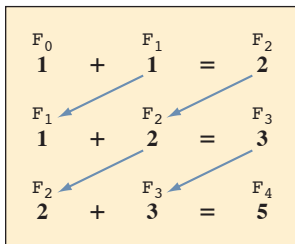

The nonrecursive method is not as succinct as the recursive version, but at the same time, it is not that difficult to understand. The nonrecursive version is much more efficient, and it is the one that should be used. This nonrecursive version is written in such a way that its structure parallels the structure of the recursive

version, so we can compare the two easily. It is possible to rewrite the nonrecursive version with a simple for loop as

```
public int fibonacci(int N) {
 int fibN1, fibN2, fibN;
 fibN = fibN1 = fibN2 = 1;
 for (int i = 1; i < N; i++) {
 fibN = fibN1 + fibN2;
 fibN1 = fibN2;
 fibN2 = fibN;
 }
 return fibN;
}
```

Let's look at another example where recursion should not be used. Consider the following method:

```
private void mainControl() {
 System.out.println("1. Search Stores");
 System.out.println("2. Floor Maps");
 System.out.println("3. Food Court Information");

 int choice = scanner.nextInt();
 process(choice); //assume input is correct
 mainControl(); //recursive call
}
```

The idea behind the method is to display menu choices and process the selected operation. We assume that this program is a dedicated software for an information kiosk at a shopping mall. Once started, the program does not terminate. The system administrator can still terminate the program by other ways and means (such as switching off the machine itself), but the end user does not have a menu choice to terminate the program.

Recursion seems natural at first for such top-level control that repeats itself indefinitely. But there's a serious problem. It will eventually result in memory overflow. Every time a recursive call is made, a data segment is allocated to store local variables (and other pieces of data). This data segment gets deallocated only when the execution of a method terminates. Because there's no test inside the `mainControl` method to stop the recursive calls, each execution of `mainControl` never returns. So the allocated data segments never get deallocated. Thus, the memory overflow will eventually occur.

A solution to this problem is remarkably simple: implement the method with an infinite loop as such

```
private void mainControl() {
 while (true) {
 System.out.println("1. Search Stores");
 System.out.println("2. Floor Maps");
 System.out.println("3. Food Court Information");

 int choice = scanner.nextInt();

 process(choice); //assume input is correct
 }
}
```

This method is executed exactly once, so only one data segment is allocated. The execution of the modified method, therefore, will never result in memory overflow.

There is no clear-cut rule to determine whether a routine should be implemented recursively or nonrecursively. In general, we should always search for a nonrecursive solution first. We should use recursion only when a recursive solution is more natural and easier to understand and the resulting method is not too inefficient. We repeat the guideline for using recursive methods we mentioned in Chapter 6.

## Design Guidelines



### Use recursion if

1. A recursive solution is natural and easy to understand.
2. A recursive solution does not result in excessive duplicate computation.
3. The equivalent iterative solution is too complex.

## Summary

- Recursion is a special type of repetition control.
- A recursive method is a method that calls itself.
- A recursive method consists of a test to stop the recursion, the end case that gets executed at the end of recursion, and the recursive case that makes a recursive call to continue the recursion.
- The use of recursion should be avoided if a suitable nonrecursive looping statement can be developed.

## Key Concepts

recursive methods  
end cases

recursive cases

## Chapter 15 Exercises

### Review Exercises

1. In Chapter 6, we gave the nonrecursive and recursive solutions for finding the greatest common divisor of two given integers. Which version is the one you should use in practice?
2. What would happen if the `anagram` method were called initially by passing an empty string as the second parameter as

```
anagram("", "");
```

Will the method work? Why or why not? If not, correct the problem. If yes, then would it be logical to leave it as is, or should the method be corrected to make it more logical?

3. What is a potential problem with the following recursive method?

```
private int getInput() {
 System.out.println("Enter Positive Integer: ");
 int val = scanner.nextInt();
 if (val <= 0) {
 System.out.println("Input Error. Try Again...");
 return getInput(); //recursive call
 } else {
 return val; //input okay, so return it
 }
}
```

### Level 1 Programming Exercises ★

4. The partition method of quicksort selects the first element as its pivot. Improve the method by using the median of the values in the first, the middle, and the last elements of an array. If an array number to partition has 8 elements indexed from 0 to 7, then the first element is `number[0]`, the middle element is `number[4]`, and the last element is `number[7]`. If these elements are 55, 34, and 89, for example, then the median is 55.
5. Write a recursive method that counts the number of characters in a given string, that is, implement the `length` method of the `String` class using recursion. Write a simple control program to test this method. *Note:* This is strictly an exercise. Under normal circumstances, you never want to reimplement a method already included in the Java API.
6. Write a recursive method to find the smallest element in an array. The method accepts an array and the index position of the next element to process. *Note:* This is strictly an exercise. You should not write the real method recursively. Write a simple control program to test this method.



7. Write a recursive method to compute the sum of the elements in an array. The method accepts an array and the index position of the next element to process. *Note:* This is strictly an exercise. You should not write the real method recursively. Write a simple control program to test this method.
8. Write a recursive method to reverse a given string. The method accepts a string as an argument and returns the reverse of the argument. For example, if the argument is Java, then the method returns avaJ. Show this method be written recursively or nonrecursively in practice? Write a simple control program to test this method.

### Level 2 Programming Exercises ★★

9. Write a recursive method to determine whether a given string is a palindrome. A string is a palindrome if it reads the same both forward and backward. Ignore the case of the letters and punctuation marks. Write a simple control program to test this method.
10. Write a recursive binary search method. Should this method be written recursively or nonrecursively in practice? Write a simple control program to test this method.

### Level 3 Programming Exercises ★★★

11. Another recursive sorting algorithm is called *merge sort*. The merge sort divides the array into two halves, sorts the two halves recursively using *mergesort*, and finally merges the two sorted halves into a sorted list. In a diagram, the process of merge sort looks like this:

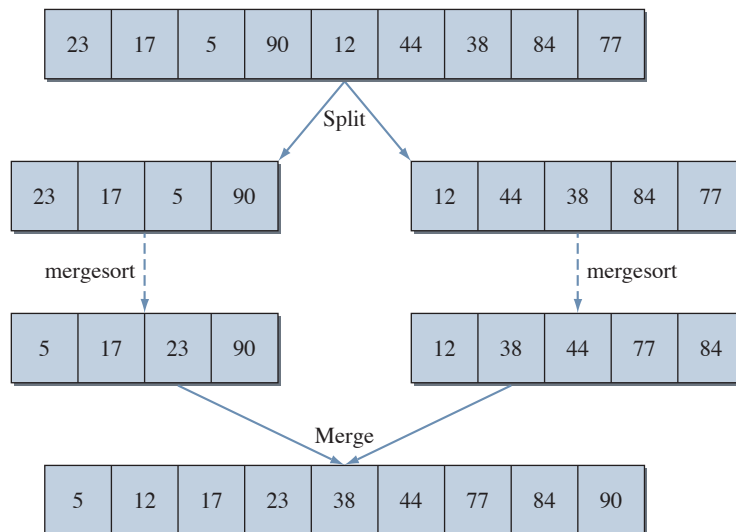

Write the mergesort method. Write a simple control program to test this method.

12. You can visualize the growth of a tree recursively. First you start with a trunk of a set length:



From this trunk, two branches grow out:



Now if you consider the two branches as the trunks of their respective subtrees, you have another growth, resulting in

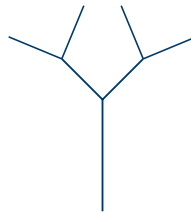

Continue this recursive growth, and you will end up with a tree that looks something like this:

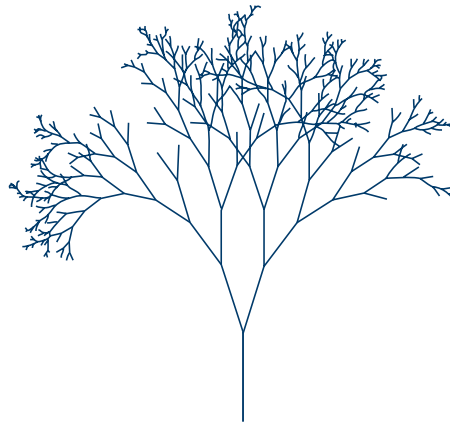

The length of the branch will get shorter and shorter. Once the length becomes shorter than some preset value, the recursion stops. Also, as you can see from the tree above, you should use some form of probability whether the branch will continue to grow or not. Try first the fixed probability of 0.9. Experiment with others, such as the probability of growth as a function based on the length of the branch. Techniques for basic drawing are explained in Chapter 5.



# Appendix A

## How to Run Java Programs

This appendix is intended for those who need to install necessary tools on their computer. Those who have an access to a computer lab with the necessary tools already installed may still want to read this appendix for general information.

In this appendix, we will explain a number of different ways of running Java programs. They can be divided broadly into three categories: minimalist, enhanced editor, and full *integrated development environment* (IDE). For the beginning programmers, we recommend the enhanced editor approach.

### Things to Remember



Please read Chapter 2 before this appendix.

At the end of this appendix, we will describe how to use classes from programmer-defined packages, such as the author-provided `javabook` package, in running your programs.

### The Minimalist Approach

In this approach we use the absolute minimum to compile and run Java programs. We need to download a necessary compiler and other tools for compiling and running Java programs from the Sun Microsystems website at <http://java.sun.com>. A collection of tools for compiling and running Java programs is called a *Java 2 SDK (Software Development Kit)*. Sun also uses the term `JDK` instead of `SDK`. `JDK` stands for `Java Development Kit`. Sun Microsystems provides three versions for `SDK`: enterprise edition (`J2EE SDK`), standard edition (`J2SE SDK`), and micro edition (`J2ME SDK`). The one you need to download is the standard edition. We describe the steps for the MS Windows platform here.

#### 1. Installation

Download the most recent version Java for MS Windows. At the time of this writing (November, 2008), the most recent version is `JDK 6 Update 10`. The website for downloading it is

<http://java.sun.com/javase/downloads/index.jsp>.

Please be aware that website addresses change frequently. If the given address does not work, you can search for the correct page starting from the Java homepage at <http://java.sun.com>.

Click the Download button next to the column heading **Java SE Development Kit (JDK) 6 Update 10**. This will take you to another page where you specify the Platform and the Language. Select Windows from the drop-down list for the Platform. (You have no choice but Multi-language for the Language selection.) Click the checkbox for I agree to the Java SE Development Kit 6 Licence Agreement. Finally, click the Continue button.

In the next page, you'll see a link labeled `jdk-6u10-windows-i586-p.exe`. Click this link. It will initiate the process of downloading the installation file. Download the file to any location of your choice on the hard disk. This file has the filename `jdk-6u10-windows-i586-p.exe`, same as the link label. Once the download is complete, double-click the file to begin the installation. You may choose any directory for installation. In this example, we assume the tools are installed in the directory

```
C:\java6
```

You may change it to any name and location you like. When the installation completes successfully, you will see a number of subdirectories, such as `bin` and `lib`, under the installation directory.

## 2. Create a Program

We are now ready to create a program. Using Notepad (or any other text editor, but don't use a word processor that saves special markers with a document), create the following program:

```
import javax.swing.*;
class MyFirstProgram {
 public static void main(String[] arg) {
 JOptionPane.showMessageDialog(null, "It works!");
 System.exit(0);
 }
}
```

Type in the program exactly as shown, making sure the uppercase and lowercase letters are entered correctly. Note: A simple text editor, such as Notepad, will display the code in black only.

## 3. Save the Program

Before we compile and run the program, let's save the program. First create a folder. (*Note:* We use the words *folder* and *directory* synonymously.) For this example, we will create a folder named `JavaPrograms` under the C: drive.

```
C:\JavaPrograms
```

Save the program by selecting the menu choice File/Save of Notepad and giving the name `MyFirstProgram.java`. Put this file in the `C:\JavaPrograms` folder. The name of the class is `MyFirstProgram`, so we save it as `MyFirstProgram.java`. If you name the program `XYZ`, then save it as `XYZ.java`. Note that it

is case-sensitive. When you use Notepad, be careful that the file is not saved as `MyFirstProgram.java.txt`. Make sure there's no `.txt` suffix appended to the filename. To avoid the automatic appending of the `.txt` suffix, don't forget to set the value for `Save as type` to `All Files`.

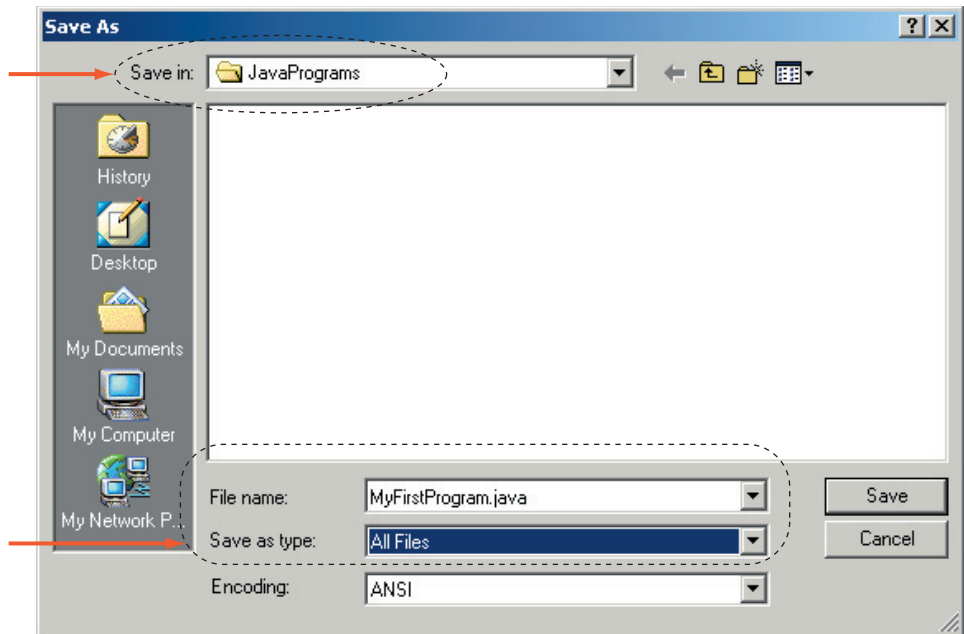

#### 4. Open a Command Prompt Window

After the source file is created and saved properly, we are ready to compile and run it. We use a command prompt window to enter the commands for compiling and running Java programs. Open a command prompt window by selecting the `Start/Run...` option

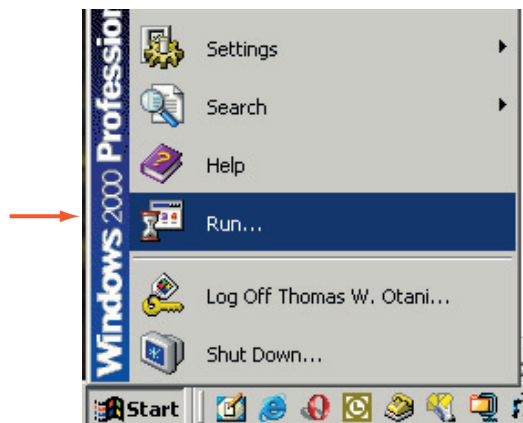

and entering the text `cmd` in the text field of the Run dialog box (if `cmd` does not work, try `command`):

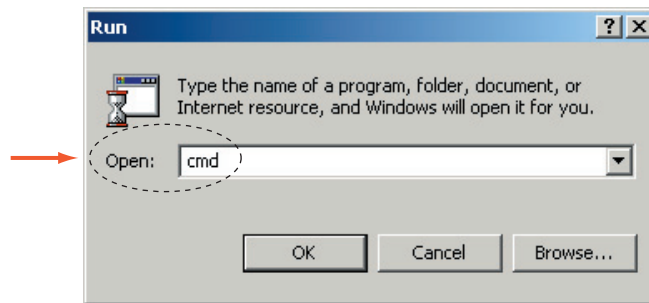

Click the OK button. A command prompt window appears on the screen:

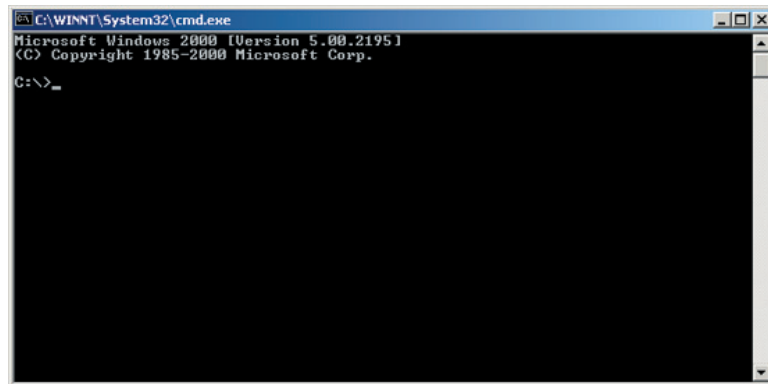

From this point on, all commands are entered in this window.

## 5. Set the Environment

Before we can actually compile and run the program, we must set the environment. First change to the `JavaPrograms` directory where the source file is stored by entering the command `cd JavaPrograms` (and pressing the Enter key):

```
C:\> cd \JavaPrograms
C:\JavaPrograms>
```

*Note: The text we enter is shown in blue. The prompt displayed by the computer is shown in black.*

*Note: It is beyond the scope of this appendix to explain DOS commands. Please consult other sources if you need to learn DOS commands.*

Enter the following two commands in sequence to set the environment:

```
C:\JavaPrograms>set path=C:\java6\bin
C:\JavaPrograms>set classpath=.
C:\JavaPrograms>
```

Enter the commands exactly as shown. Do not introduce any spaces between the equals symbols (=), for example. The first command sets the PATH environment variable so we can refer to the executable files in the bin subdirectory of C:\java6. The second command tells the Java compiler and interpreter where to find the source files. The period (.) indicates the current directory. You need to enter the two commands only once.

## 6. Compile the Program

Finally we are ready to compile the program. To compile a Java source file, use the `javac` command followed by the filename of the source file. Enter the following command exactly, that is, in a case-sensitive manner:

```
C:\JavaPrograms>javac MyFirstProgram.java
```

After a moment of pause, when there's no error in the program, the prompt to enter the next command appears. An error message will appear if there's an error. If that happens, go back to Notepad and check the program. Make any necessary changes and save it again. Then enter the `javac` command again. As explained in Chapter 2, successful compilation will result in a creation of a bytecode file.

## 7. Run the Program

After the successful compilation of the program, we are finally ready to run the program by executing its bytecode file. To run the program, we use the `java` command followed by the name of the bytecode file (with no suffix). Enter the following command and press the Enter key:

```
C:\JavaPrograms> java MyFirstProgram
```

The program starts and a message dialog appears on the screen:

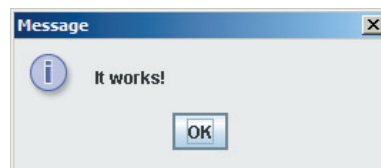

Close this message dialog by clicking its OK button. Congratulations! You have successfully executed your first Java program.



## The Significance of the `System.exit` Statement

The last statement of the sample program was

```
System.exit(0);
```

which caused the program to terminate. If you adopt the minimalist approach of using Notepad (or another simple text editor) and a command prompt window, you must include the exit statement to terminate the sample `MyFirstProgram` program. If you don't, then the program will not terminate. The message dialog disappears from the screen when you click its OK button, but the program is still active. When this happens, you will not get another prompt in the command prompt window. And, of course, without getting a command prompt, you can't enter another command anymore. Not all programs behave in this way. Specifically, a program that uses console-based standard input and output does not require the exit statement, while a program that uses GUI-based input and output (such as `MyFirstProgram` that uses the GUI-based `JOptionPane` for output) requires the exit statement. When you are using the minimalist approach, the easiest thing to do is to include the exit statement for all programs.

## The Enhanced Editor Approach

For a very simple program, the minimalist approach may be an acceptable alternative. However, when the programs we develop become larger, the minimalist approach becomes cumbersome. Unlike with the minimalist approach in which we have to deal with separate tools for editing (Notepad) and running (command prompt) programs, with the enhanced editor approach, we interact with a single tool that will let us edit, compile, and run Java programs. For the beginning programmers, we recommend the enhanced editor approach.

There are a number of good software tools that fall under this category. Some of the more well-known ones are

- `jGrasp` ([www.eng.auburn.edu/grasp](http://www.eng.auburn.edu/grasp))
- `TextPad` ([www.textpad.com](http://www.textpad.com))
- `jEdit` ([www.jedit.org](http://www.jedit.org))
- `JCreator` ([www.jcreator.com](http://www.jcreator.com))
- `BlueJ` ([www.bluej.org](http://www.bluej.org))

You can look for other enhanced editors by visiting Google and entering the search text "Java editors." Most of these tools are available free or for a nominal fee. The enhanced Java editors are diverse in user interface style and the options they support, but they share two key features:

1. Support of color syntax highlighting. Different portions of the code are displayed in different colors (reserved words in blue, comments in green, string constants in cyan, and so forth).
2. Use of Java SDK. The enhanced editors provide us with an environment where we can enter, compile, and run Java programs, but the actual compilation and

execution of programs are done by Java SDK tools (`javac`, `java`, etc.). In other words, instead of dealing with Java SDK tools directly by entering commands in the command prompt window, we deal with them by selecting corresponding menu choices of the enhanced editor.

Since we cannot describe the enhanced editors adequately in a limited space, we refer you to their respective websites for instructions on how to use them.

## The IDE Approach

Tools in the IDE approach are geared toward serious programmers developing large-scale programs. Eclipse and NetBeans are two well-known full IDEs. In addition to many features, they typically include a visual editor that lets programmers design the user interface of a program visually by dragging and dropping GUI objects from the component palettes. They are complicated, and it takes time to master and use the various features supported by them properly. For this reason, this approach is not recommended for beginning programmers.

## Using Programmer-Defined Packages

When we are using classes from the system packages such as `javax.swing`, `java.util`, and others, all we do is to include appropriate import statements in the program. This is not enough when we are using classes from programmer-defined packages. We must also set the environment correctly. How we set the environment is dependent on the development tools we use. We will describe how to set the environment to use programmer-defined packages with the minimalist approach. Please consult the relevant user manual for information on using programmer-defined packages with the enhanced editor approach.

We will use the author-provided `galapagos` package as an example to illustrate the procedure. You can download this package and its documentation from the textbook website. We assume you have downloaded and installed the `galapagos` classes under the `C:\JavaPrograms\galapagos` directory. Notice that the name of the package is `galapagos`, and the directory that contains the classes in this package is also named `galapagos`. This is the requirement. The classes in the package `xyz` must be placed in the directory named `xyz`. The directory `xyz`, however, can be placed anywhere you want. In this example, we put the `galapagos` directory under `C:\JavaPrograms`. When the installation is done correctly, you should see the source and bytecode files of the `galapagos` classes in the `C:\JavaPrograms\galapagos` directory.

### Things to Remember



*For this example, we assume that the classes from the author-provided **galapagos** package are placed in the directory.*

`C:\JavaPrograms\galapagos`

All you have to do is to change the setting for the class path as follows:

```
set classpath=.;c:\JavaPrograms
```

Notice that we specify the directory that contains the galapagos directory.

### Things to Remember



To use the **galapagos** classes stored in the directory **C:\Javaprograms\galapagos**, set the class path by entering the command.

```
set classpath=.;c:\JavaPrograms
```

# Appendix B

## Sample Programs

In this appendix, we provide a chapter-by-chapter list of all sample classes (programs). For each sample class, we provide a brief description, the page number where the class is listed or discussed, and a list of system classes used by this class. You can download the source files of all sample classes (programs) from the McGraw-Hill book website at <http://www.mhhe.com/wu>.

### Chapter-by-Chapter List

The single asterisk means only the fragment of the program is listed in the main text. The double asterisks mean the program is not listed in the main text. Such programs are provided as additional examples or variations on the programs listed in the main text.

<chapter #>		
Name	Page #	Standard Classes
<class name>	<page # where the class is listed>	<list of standard classes or interfaces used or referred to in the class> <i>Note:</i> Unless the <b>String</b> class is the major focus of a program, it will not be listed in this column. Also, <b>System</b> will not be listed.
<A brief description of the class>		
<class used in the sample development>		

CHAPTER 2		
Class Name	Page #	Standard Classes
Ch2Sample1	31	JFrame
This program opens a simple <b>JFrame</b> window.		
Ch2StringProcessing	59	String
Illustrates string processing with the <b>substring</b> , <b>indexOf</b> , and <b>length</b> methods of the <b>String</b> class.		

Chapter 2 (Continued)		
Class Name	Page #	Standard Classes
Ch2DateDisplay	62	Date SimpleDateFormat
Creates and displays today's date in two different styles: one in the format <b>1/19/09 9:20 AM</b> and another in the format <b>Monday January 19, 2009</b> .		
Ch2Greetings	67	String Scanner
Accepts a name as a string input and replies with a greeting.		
Ch2RecordFiling	68	Scanner
Input first and last names individually and display the name in the last name, first name format.		
Ch2Monogram	72, 74	String Scanner
A class in the Chapter 2 sample development program that accepts a full name as a string input and displays the monogram of the input name.		

CHAPTER 3		
Class Name	Page #	Standard Classes
Ch3Circle	103	String
Assigns a value to a radius and displays the circle's area and circumference.		
Ch3Circle2**	N/A	String DecimalFormat
Same as <b>Ch3Circle</b> , but restricts the fractional values to three decimal places when displaying the area and circumference. Formatting of the <b>double</b> values is done by using the <b>DecimalFormat</b> class.		
Ch3Circle3	106	String DecimalFormat
Same as <b>Ch3Circle2</b> but with additional formatting with control characters.		
Ch3Circle4	112	Scanner
Same as <b>Ch2Circle3</b> but inputs a value for the radius using the <b>Scanner</b> class.		
Ch3PoleHeight	116	DecimalFormat Math Scanner
Computes the height of a given pole. Illustrates mathematical computation using the class methods of the <b>Math</b> class.		

Chapter 3 (Continued)		
Class Name	Page #	Standard Classes
Ch3SelectWinner	119	Scanner Random
This program selects a random number between M and M+N, where M and N are inputs to the program. The program uses the <b>Random</b> class to generate random numbers.		
Ch3TestCalendar	122	GregorianCalendar
Illustrates how to use the <b>GregorianCalendar</b> class for date manipulation.		
Ch3IndependenceDay	123	GregorianCalendar SimpleDateFormat
This program displays the day of the week of a designed date (in this example, we chose Independence Day). The date is specified in the program by changing the arguments in the <b>GregorianCalendar</b> constructor.		
Ch3FindDayOfWeek	123	GregorianCalendar SimpleDateFormat Scanner
Same as <b>Ch3IndependenceDay</b> but this program accepts year, month, and day as input and displays the day of the week of the given date.		
Ch3LoanCalculator	128, 130, 132, 134	DecimalFormat Math Scanner
Computes and displays the monthly and total payments for a given loan amount, loan period, and interest rate.		

CHAPTER 4		
Class Name	Page #	Standard Classes
BicycleRegistration	152	
This is a sample main class that uses two <b>Bicycle</b> objects.		
Bicycle	153	
A sample programmer-defined class that models a bicycle.		
SecondMain	163	
This sample program shows the use of two programmer-defined classes <b>Bicycle</b> and <b>Account</b> .		
Account	164	
This is the second sample programmer-defined class. It models a bank account.		
Student	168	
This programmer-defined class models a student.		

Chapter 4 (Continued)		
Class Name	Page #	Standard Classes
LibraryCard	169	
This programmer-defined class models a library card.		
Librarian	171	
This main class shows the sample usage of the <b>Student</b> and <b>LibraryCard</b> classes.		
AccountVer2	175	
A version of the <b>Account</b> class that includes a constructor with two parameters.		
Element	178	
This class models an element in the periodic table.		
AccountVer3	183	
Another version of the <b>Account</b> class. This version illustrates the use of a class constant that represents a fee charged for withdrawals.		
DeductionWithFee	184	DecimalFormat
A sample main class that uses the <b>AccountVer3</b> class.		
Die	186	Random
A programmer-defined class that models a die. The class shows how a random number between 1 and 6 is generated by using the <b>random</b> method of the <b>Math</b> class.		
RollDice	187	
This is a main class that shows the sample usage of the <b>Die</b> class.		
LotteryCard	188	Random
A programmer-defined class that models a lottery card. Each card is randomly assigned a number between 10 and 15 and one of the three possible colors—red, green, or blue.		
RoomWinner	189	
This is a main class that shows the sample usage of the <b>LotteryCard</b> class.		
AccountVer4	194	
This is the fourth version of the <b>Account</b> class. This version shows the use of a private method.		
DieVer2	195	Random
This version of the <b>Die</b> class illustrates the calling of a private method from the constructor.		
Bicycle	197	
This version of the <b>Bicycle</b> class includes the main method. This version is stored in a separate subfolder to avoid the naming conflict with the original class.		

Chapter 4 (Continued)		
Class Name	Page #	Standard Classes
Loan	204, 207, 210, 211	Random
An instance of this class maintains three pieces of loan information: amount, period, and interest rate.		
LoanCalculator	203, 206, 209	
The top-level controller class for the loan program. This class is defined as an instantiable main class.		

CHAPTER 5		
Class Name	Page #	Standard Classes
Ch5Circle	229	
This class illustrates the use of <b>if</b> statements. An instance of this class can compute the area and circumference of a circle, given the radius.		
Ch5Sample1	231	
A program to test the operations of the <b>Ch5Circle</b> class.		
Ch5Account	238	
This version of the <b>Account</b> class shows the use of selection control in the <b>add</b> and <b>deduct</b> methods.		
Ch5AccountVer2	245	
This is an improved version of the <b>Ch5Account</b> class. This version includes a boolean data member <b>active</b> that records the state of an account—active or inactive.		
Fraction*	249	
A programmer-defined class that illustrates how objects are compared.		
Ch5SampleGraphics	257	JFrame Graphics
This class illustrates how a <b>Graphics</b> object is used by drawing a rectangle and filled rectangle on a frame window.		
Ch5SampleGraphics2	262	JFrame Graphics Color
This class is the same as the <b>Ch5SampleGraphics</b> class, but draws the rectangles in blue and red.		
Ch5RoomWinner	264	JFrame Container Graphics
This is the graphics version of the RoomWinner class from Chapter 4.		
GraphicLotteryCard	265	Graphics
The graphics version of the LotteryCard class from Chapter 4. This class is used by the Ch5RoomWinner class.		



Chapter 5 (Continued)		
Class Name	Page #	Standard Classes
DrawableShape	279, 286, 290	Point Dimension Color Graphics
The class encapsulates the functionalities of a shape that can be drawn.		
DrawingBoard	N/A	
This is a helper class given to you as support for implementing this application.		
Ch5DrawShape	277, 280, 284, 289, 291	
This is the instantiable main class of the sample development program.		

CHAPTER 6		
Class Name	Page #	Standard Classes
Ch6SleepStatistics	309	DecimalFormat Scanner
This program computes the average sleeping time of dorm residents. This program uses a <b>while</b> loop.		
Ch6GCD*	311	Math
This class shows a number of different ways for finding the greatest common divisor of two given integers.		
Ch6DroppingWaterMelon	329	Math Scanner
This program inputs the initial height and computes the position of a watermelon every second until it touches the ground. This program illustrates the use of the <b>for</b> loop.		
Ch6ComplexForLoops*	330	Math
This program illustrates the use of complex <b>for</b> loops.		
Ch6CarpetPriceTable*	332	
This program illustrates the use of nested <b>for</b> loops. The program outputs the price of a carpet ranging in size from 5 by 11 to 25 by 20.		
Ch6CarpetPriceTable- withFormat	338	
This class modifies the <b>Ch6CarpetPriceTable</b> class by formatting the output values. The format is done by using <b>Ch6Format</b> .		

Chapter 6 (Continued)		
Class Name	Page #	Standard Classes
Ch6TimeGcd	343	Date Scanner
This program illustrates the technique of timing the execution by using the <b>Date</b> class.		
Ch6HiLo	354	
A sample development program that plays the HiLo game.		
TestRandom	360	Random
A simple test program for Step 3 to check the random number generation.		

CHAPTER 7		
Class Name	Page #	Standard Classes
Fraction	410	
This sample class models a fraction. The class definition includes almost all the fundamental object-oriented concepts covered in Chapters 4 and 7. The class is placed in the package named <b>myutil</b> .		
Ch7Fraction_Test1**	N/A	
A simple test class that adds two <b>Fraction</b> objects.		
Ch7Fraction_Test2**	N/A	
Another main class to test the operations of the <b>Fraction</b> class.		
LibraryBook	423	
This class models a library card.		
Step1Main	425	GregorianCalendar
The main class to test the step 1 <b>LibraryBook</b> class.		
Step2Main	428	GregorianCalendar Scanner
The step 2 main class to test the operations of the helper class <b>BookTracker</b> .		
OverDueChecker	430	GregorianCalendar Scanner
The main class of the sample development program.		

CHAPTER 8		
Class Name	Page #	Standard Classes
Ch8Sample1*	446	Scanner
This sample program illustrates the throwing of <b>InputMismatchException</b> when an input is not an <b>int</b> .		
AgeInputVer1	447	Scanner
This is the first version of a class that provides methods to input ages. This class includes no exception handling routines; i.e., the system will handle any thrown exceptions.		
Ch8AgeInputMain	448	GregorianCalendar Scanner
A test program to illustrate the behavior of different versions of the age input class. The program asks for the user's age and replies with the year in which the user was born.		
AgeInputVer2*	451	Scanner
The second version of the age input class with the <b>try-catch</b> exception handling. Its <b>getAge</b> method will not return until a valid integer is entered. The method includes a <b>while</b> loop that repeats until a valid integer is entered. The loop continues while there's a number format exception.		
AgeInputVer3*	453	Scanner
The third version of the age input class that improves the second version by throwing an exception when the input is a negative integer.		
AgeInputVer4	464	Scanner
In this fourth version of the age input class, a client programmer can set the lower and upper bounds of the acceptable input age values. An exception is thrown if the input value is not an integer (as in previous versions) or violates the specified bounds.		
Ch8TestAgeInputVer4**	N/A	
This driver program tests the behavior of the <b>AgeInputVer4</b> class.		
AgeInputException	469	
This is a programmer-defined exception class that includes the designated lower and upper bounds and the input value that violates the specified bounds.		
AgeInputVer5**	N/A	Scanner
The fifth version of the age input class is similar to the fourth version. The key difference is the throwing of programmer-defined exception <b>AgeInputException</b> when the input value is outside the range of specified bounds.		
Ch8TestAgeInputVer5	470	
This driver program tests the behavior of the <b>AgeInputVer5</b> class		
BankAccount	471	
A sample class that specifies assertions in the <b>deposit</b> and <b>withdraw</b> methods.		
Ch8TestAssertMain	464	Scanner
A driver program to test the behavior of the <b>BankAccount</b> class.		

Chapter 8 (Continued)		
Class Name	Page #	Standard Classes
Resident	482	
		An instance of this class represents a dorm resident. A <b>Resident</b> object has name, room number, and password.
Door**	N/A	
		This helper class models the entrance door of a dorm.
Dorm**	N/A	
		This helper class models a dorm. A <b>Dorm</b> object maintains a list of <b>Resident</b> objects.
Ch8EntranceMonitor	484	
		The main class of the program.
SampleCreateResidentFile	485	
		A simple (self-contained) program to create sample test data for the <b>Ch8EntranceMonitor</b> program.
InputHandler	487	
		The user interface of the application that accepts the name, room number, and password.

CHAPTER 9		
Class Name	Page #	Standard Classes
Ch9TestChar*	498	
		A simple illustration of conversion between <b>char</b> and <b>int</b> .
Ch9CountVowels	501	Scanner String
		Illustrates basic string processing. The program counts the number of vowels in a given string.
Ch9CountVowels2	502	Scanner String
		Same as <b>Ch9CountVowels</b> but uses the <b>toUpperCase</b> method to simplify the testing.
Ch9CountWords	504	Scanner String
		The program counts the number of words in a given string. This program has a minor bug of counting one more than the actual number of words if there is one or more spaces at the end.

Chapter 9 (Continued)		
Class Name	Page #	Standard Classes
Ch9CountJava	506	Scanner String
This program inputs words (one word at a time) and counts the number of times the word <b>java</b> occurs in input (case-insensitive comparison). The program terminates when the word <b>STOP</b> (case-sensitive) is entered.		
Ch9ExtractWords	508	Scanner String
This programs extracts words from a given string and displays them one word per line.		
Ch9PatternMatch1**	N/A	Scanner String
A simple illustration of the <b>matches</b> method, a pattern-matching method of the <b>String</b> class.		
Ch9MatchJavaIdentifier	512	Scanner String
This program illustrates the basic pattern-matching technique by showing how to determine whether a given input word is a valid Java identifier.		
Ch9MatchPhoneNumber	513	Scanner String
This program illustrates the basic pattern-matching technique by showing how to determine whether a given input is a valid phone number.		
Ch9MatchPhoneNumberPM**	N/A	Scanner String Matcher Pattern
Performs the same task as <b>Ch9MatchPhoneNumber</b> but uses the <b>Matcher</b> and <b>Pattern</b> classes.		
Ch9MatchJavaIdentifierPM	518	Scanner String Matcher Pattern
Performs the same task as <b>Ch9MatchJavaIdentifier</b> but uses the <b>Matcher</b> and <b>Pattern</b> classes.		
Ch9CountJavaPM	519	Scanner String Matcher Pattern
Performs the same task as <b>Ch9CountJava</b> but uses the pattern-matching technique with the <b>Matcher</b> and <b>Pattern</b> classes.		

Chapter 9 (Continued)		
Class Name	Page #	Standard Classes
Ch9LocateJavaPM	520	
Similar to <b>Ch9PMCountJava</b> but instead of counting the number of occurrences, this program displays the locations in the string where the word <b>java</b> is found.		
Ch9ReplaceVowelWithX	524	Scanner String StringBuffer
This program illustrates the use of the <b>StringBuffer</b> class by showing how the vowels in a given string are replaced by character <b>X</b> .		
Ch9EvenLetterWords	526	Scanner String StringBuffer
Another sample program illustrating the use of the <b>StringBuffer</b> class. This program extracts words with an even number of letters from a given string and creates a new string with these words.		
Ch9GCCContent	530	Scanner
The program determines the GC-content of a given DNA sequence composed of letters A, T, G, and C.		
Ch9TranscribeDNA	531	Scanner
Transcribes the given DNA into RNA by replacing thymine(T) with uracil(U).		
Ch9ReverseDNA	532	Scanner
Outputs the reverse sequence of a given DNA.		
FileManager**	N/A	
This is a helper class for reading from and saving data to a text file.		
WordList**	N/A	
This is a helper class for maintaining a word list.		
Ch9WordConcordance	537, 542, 545	Matcher Pattern
This class creates a word concordance for a given document. For each word in the document, the number of times the word occurs in the document is kept.		
Ch9WordConcordanceMain	536, 541	Scanner String FileNotFoundException IOException
The instantiable main class of the program.		

CHAPTER 10		
Class Name	Page #	Standard Classes
Ch10RainFall	559	Scanner
The first sample program that illustrates the use of one-dimensional array of numbers. The program computes the annual average rainfall and the variation from the monthly averages.		
Ch10RainFall2*	561	Scanner
The variation of <b>Ch10RainFall</b> that uses an array of <b>String</b> so the month name is used to prompt the user when inputting monthly rainfall averages. The original <b>Ch10RainFall</b> uses month number (1, 2, etc.) instead of month names (January, February, etc.).		
Ch10RainFallStat	563	Scanner
More examples of using arrays by showing how to compute various statistics from given monthly rainfall averages.		
Person**	N/A	
A simple class used by <b>Ch10ProcessPersonArray</b> to illustrate how an array of objects is processed.		
Ch10ProcessPersonArray	573	Scanner
This class illustrates the processing of an array of <b>Person</b> objects.		
Ch10TestArrayParameter*	582	Scanner
This class is a collection of methods to show how an array is passed to a method.		
Ch10PayScaleTable	594	
This sample program maintains a pay scale table by using a two-dimensional array of <b>double</b> .		
Ch10FriendsList*	599	List ArrayList
A simple program to show how a list of <b>Person</b> objects can be manipulated with an <b>ArrayList</b> .		
BookTracker	604	List LinkedList
The helper class for the Chapter 7 sample development program. This class maintains a list of library books.		
WordList	607	SortedMap TreeMap
The helper class for the Chapter 9 sample development program. This class maintains a word list to track the number of times each word in the list occurs in a given document.		
Person**	N/A	
A logical class that represents a person. This class is the same as the <b>Person</b> class used in the regular sample programs.		
AddressBook	611	
This class implements functionalities of an address book for keeping track of persons. The class supports insertion, deletion, and search operations. Assertion statements are used in this class.		
TestAddressBook	612, 617, 620, 624	
A test program to check the operations of <b>AddressBook</b> .		

CHAPTER 11		
Class Name	Page #	Standard Classes
<code>SearchRoutines*</code>	635	
The class defines two search methods—linear and binary search.		
<code>Ch11TestLinearSearch**</code>	N/A	
A driver program to test the linear search method defined in <b>SearchRoutines</b> .		
<code>Ch11TestBinarySearch**</code>	N/A	<code>System</code>
A driver program to test the binary search method defined in <b>SearchRoutines</b> .		
<code>SortingRoutines*</code>	640	
The class defines two sorting methods—selection and bubble sort.		
<code>Ch11TestSelectionSort**</code>	N/A	
A driver program to test the selection sort method defined in <b>SortingRoutines</b> .		
<code>Ch11TestBubbleSort**</code>	N/A	
A driver program to test the bubble sort method defined in <b>SortingRoutines</b> .		
<code>Heap</code>	651	
This class implements the heapsort sorting method.		
<code>Ch11TestHeapSort**</code>	N/A	
A driver program to test the sorting method defined in <b>Heap</b> .		
<code>AddressBook (interface)</code>	660	
This interface defines the behavior of an address book that maintains a collection of <b>Person</b> objects. An address book is capable of adding and removing objects and sorting objects by their name or age.		
<code>Person</code>	665	
A logical class that represents a person. The class includes methods to compare its instances.		
<code>AddressBookVer1</code>	668	
This class implement the <b>AddressBook</b> interface by using an array of <b>Person</b> objects. Bubble sort is used to sort the objects.		
<code>AddressBookVer2</code>	675	<code>Arrays</code>
This class implements the <b>AddressBook</b> interface by using an array of <b>Person</b> objects. For sorting, it uses the generic sorting method included in the <b>Arrays</b> class.		
<code>AgeComparator (inner class)</code>	676	
The inner class of <b>AddressBookVer2</b> and <b>AddressBookVer3</b> that compares two <b>Person</b> objects on their ages.		



Chapter 11 (Continued)		
Class Name	Page #	Standard Classes
NameComparator (inner class)	677	
The inner class of <b>AddressBookVer2</b> and <b>AddressBookVer3</b> that compares two <b>Person</b> objects on their names.		
AddressBookVer3	678	Map HashMap Arrays
This class implements the <b>AddressBook</b> interface by using an array of <b>Person</b> objects. The <b>HashMap</b> class is used for managing <b>Person</b> objects and the <b>Arrays</b> class for sorting <b>Person</b> objects.		
TestAddressBookSorting**	N/A	
A driver program to test the sorting routine of the address book.		

CHAPTER 12		
Class Name	Page #	Standard Classes
Ch12TestJFileChooser	691	JFileChooser File
A simple program that shows how to use <b>JFileChooser</b> and <b>File</b> classes.		
JavaFilter	693	FileFilter File
A simple program to illustrate the use of file filter to list only Java source files in a <b>JFileChooser</b> .		
Ch12TestFileOutputStream	696	IOException File FileOutputStream
A test program to save data to a file using <b>FileOutputStream</b> .		
Ch12TestFileInputStream	698	IOException File FileInputStream
A test program to read data from a file using <b>FileInputStream</b> .		
Ch12TestDataOutputStream	700	IOException File FileOutputStream DataOutputStream
A test program to save data to a file using <b>DataOutputStream</b> .		

<b>Chapter 12</b> <i>(Continued)</i>		
<b>Class Name</b>	<b>Page #</b>	<b>Standard Classes</b>
Ch12TestDataInputStream	701	IOException File FileInputStream DataInputStream
A test program to read data from a file using <b>DataInputStream</b> .		
Ch12TestPrintWriter	703	IOException File FileOutputStream PrintWriter
A test program to save data to a text file using <b>PrintWriter</b> .		
Ch12TestBufferedReader	704	IOException File FileReader BufferedReader
A test program to read text data from a text file using <b>BufferedReader</b> .		
Ch12TestScanner	706	FileNotFoundException IOException File Scanner
A test program to read text data from a text file using <b>Scanner</b> .		
FileManager (Ch 9 Helper class)	707	FileNotFoundException, IOException, File, FileReader, BufferedReader, FileOutputStream, PrintWriter, JFileChooser
The helper class for <b>Ch9WordConcordance</b> program used for saving to and reading data from a text file.		
Ch12TestObjectOutputStream	710	IOException File FileOutputStream ObjectOutputStream
A test program to save objects to a file using <b>ObjectOutputStream</b> .		
Ch13TestObjectInputStream	712	ClassNotFoundException, File, FileInputStream, ObjectInputStream
A test program to read objects from a file using <b>ObjectInputStream</b> .		

Chapter 12 (Continued)		
Class Name	Page #	Standard Classes
Dorm (Ch 8 Helper Class)	714	FileNotFoundException, IOException, IllegalArgumentException, ClassNotFoundException, File, FileInputStream, ObjectInputStream, FileOutputStream, ObjectOutputStream, StringBuffer
This helper class for Chapter 8 Sample Development maintains a list of <b>Resident</b> objects. In addition, the class supports file input and output operations.		
Ch12JavaViewer**	N/A	JFileChooser File
This program displays the content of a Java source file.		
Person**	N/A	Serializable
The same class from Chapter 11, but modified to implement the <b>Serializable</b> interface so its instances can be saved to a file.		
AddressBook (interface)	660 (from Chapter 11)	
The same interface from Chapter 11.		
AddressBookVer1	668 (from Chapter 11)	
The same class from Chapter 11.		
AddressBookStorage	718,720,722	IOException, File, FileOutputStream, ObjectOutputStream, FileInputStream, ObjectInputStream
This class provides file input and output services to save to and read <b>AddressBook</b> objects from a file.		
TestAddressBookStorage	719	
This class tests the constructor and the setFile method.		
TestAddressBookWrite	721	IOException
This class tests the write operation.		
TestAddressBookRead	723	IOException
This class tests the read and search operations.		
TestAddressBookFinal**	N/A	IOException
This class tests the read and write operations.		

CHAPTER 13		
Class Name	Page #	Standard Classes
Pet	734	This is a superclass of both <b>Cat</b> and <b>Dog</b> .
Cat	735	This class models a cat. The class is a subclass of <b>Pet</b> .
Dog	735	This class models a dog. The class is a subclass of <b>Pet</b> .
Ch13TestCatAndDog**	N/A	A sample program that illustrates the use of the <b>Cat</b> and <b>Dog</b> classes.
Student	738	This class models a student entity.
GraduateStudent	739	A subclass of <b>Student</b> to model a graduate student entity.
UndergraduateStudent	740	A subclass of <b>Student</b> to model an undergraduate student entity.
Ch13TestStudents**	N/A	This illustrates a sample processing of the Student class and its subclasses.
one.Super	744	This is a sample superclass to illustrate the inheritance member accessibility.
two.Sub	745	This is a sample subclass of one.Super to illustrate the inheritance member accessibility.
Client	746	This is a sample client class that uses one.Super and two.Sub classes.
Student**	N/A	A slightly different version of the <b>Student</b> class used in the sample development program. This version is declared as an abstract class.
GraduateStudent**	N/A	A slightly different version of the <b>GraduateStudent</b> subclass used in the sample development program.
UndergraduateStudent**	N/A	A slightly different version of the <b>UndergraduateStudent</b> subclass used in the sample development program.

Chapter 13 (Continued)		
Class Name	Page #	Standard Classes
OutputWindow	N/A	
This is a helper class that supports a dialog window for displaying text output.		
MainWindow	N/A	
This is a helper class that models a frame window. The frame window appears at the center of the screen.		
ComputeGrades	764,768 770,775	File, FileReader, BufferedReader, StringTokenizer, JFileChooser
The main class of the grading program that determines the course grade for graduate and undergraduate students using a different formula. To illustrate inheritance, this class is defined as the subclass of <b>MainWindow</b> .		

CHAPTER 14		
Class Name	Page #	Standard Classes
Ch14ShowMessageDialog	791	JOptionPane
A sample program that illustrates the use of <b>JOptionPane</b> for displaying a text in a dialog window.		
Ch14DefaultJFrame	794	JFrame
A test program to check the default properties of a <b>JFrame</b> object.		
Ch14JFrameSubclass1	796	JFrame
A simple subclass of <b>JFrame</b> to illustrate the basics of inheritance.		
Ch14TestJFrameSubclass	797	
A test main class that creates an instance of <b>Ch14JFrameSubclass1</b> .		
Ch14JFrameSubclass2	798	JFrame
Same as the <b>Ch7JFrameSubclass1</b> but this class sets the background of a frame to white.		
Ch14JButtonFrame	800	JFrame JButton
A subclass of <b>JFrame</b> with two <b>JButton</b> objects. This class only does the layout; no events are processed.		
ButtonHandler	805	JRootPane JButton ActionListener
An instance of this class is registered as an action event listener for two buttons in the <b>Ch7JButtonEvents</b> frame.		

Chapter 14 (Continued)		
Class Name	Page #	Standard Classes
Ch14JButtonEvents	805	JFrame JButton
This class is an extension of <b>Ch7JButtonFrame</b> by adding event-handling routines. The event handler is an instance of <b>ButtonHandler</b> (see below).		
Ch14JButtonFrameHandler	807	JFrame JButton ActionListener
This class places two <b>JButton</b> objects on its frame and handles the action events of the buttons. This class combines the functionalities of <b>Ch14ButtonEvents</b> and <b>ButtonHandler</b> .		
Ch14TextFrame1	811	JFrame JButton JTextField ActionListener
This class places two buttons ( <b>JButton</b> ) and one text field ( <b>JTextField</b> ) and handles actions events generated by these three GUI components.		
Ch14TextFrame2	814	JFrame, JLabel, JButton, JTextField, ImageIcon, ActionListener
Similar to <b>Ch14TextFrame1</b> , but adds <b>JLabel</b> objects. How an image is added to a <b>JLabel</b> is demonstrated in this class.		
Ch14TextFrame3	817	JFrame, JButton, JTextField, JTextArea, BorderLayout, ActionListener.
This class places two buttons, one text field, and one text area. String data entered in the text field are added to the strings in the text area when an action event is generated.		
Ch14FlowLayoutSample	821	JFrame FlowLayout JButton
A sample frame to illustrate the placing of GUI objects with the <b>FlowLayout</b> manager.		
Ch14BorderLayoutSample	824	JFrame BorderLayout JButton
A sample frame to illustrate the placing of GUI objects with the <b>BorderLayout</b> manager.		
Ch14GridLayoutSample	826	JFrame BorderLayout JButton
A sample frame to illustrate the placing of GUI objects with the <b>GridLayout</b> manager.		

Chapter 14 (Continued)		
Class Name	Page #	Standard Classes
Ch14AbsolutePositioning	828	JFrame JButton
A sample frame to illustrate the placing of GUI objects with no layout manager, i.e., using absolute positioning.		
Ch14NestedPanels1	832	JFrame, JPanel, BorderLayout, GridLayout, BorderLayout, JButton
A sample frame to illustrate the placing of nested panels with each panel having a different layout manager.		
Ch14NestedPanels2	834	JFrame, JPanel, BorderLayout, GridLayout, BorderLayout, JButton, JTextField, JLabel
A redesigned GUI for the HiLo game using nested panels.		
Ch14TicTacToeCell	836	JPanel, JLabel, ImageIcon, BorderLayout, BorderLayout, Point
An instance of this class represents a single cell in the Tic Tac Toe game board. A standard game is 3 X 3 so there are 9 cells.		
Ch14TicTacToePanel	838	JPanel MouseListener
A panel for displaying the Tic Tac Toe game board. This sample class illustrates the use of nested panels.		
Ch14JCheckBoxSample1	840	JFrame, ActionListener,(ActionEvent, JPanel, JButton, BorderLayout, GridLayout, FlowLayout, BorderLayout, JCheckBox
A sample frame to illustrate the use of <b>JCheckBox</b> .		
Ch14JCheckBoxSample2	842	JFrame, ActionListener,(ActionEvent, ItemListener, ItemAction, JPanel, JButton, BorderLayout, GridLayout, FlowLayout, BorderLayout, JCheckBox
This is an extended version of <b>Ch14JCheckBoxSample1</b> that process item events in addition to action events.		

<b>Chapter 14</b> <i>(Continued)</i>		
<b>Class Name</b>	<b>Page #</b>	<b>Standard Classes</b>
Ch14JRadioButtonSample	845	JFrame, ActionListener, ActionEvent, ItemListener, ItemAction, JPanel, JButton, BorderLayout, GridLayout, FlowLayout, BorderFactory, JRadioButton
A sample frame to illustrate the use of <b>JRadioButton</b> .		
Ch14JComboBoxSample	848	JFrame, ActionListener, ActionEvent, ItemListener, ItemAction, JPanel, JButton, BorderLayout, GridLayout, BorderFactory, JRadioButton
A sample frame to illustrate the use of <b>JComboBox</b> .		
Ch14JListSample	852	JFrame, ActionListener, ActionEvent, JPanel, JButton, BorderLayout, GridLayout, FlowLayout, BorderFactory, JScrollPane, JList
A sample frame to illustrate the use of <b>JList</b> .		
Ch14JSliderSample	855	JFrame, ChangeListener, ChangeEvent, JPanel, JButton, BorderLayout, BorderFactory, JSlider
A sample frame to illustrate the use of <b>JSlider</b> .		
Ch14JMenuFrame	859	JFrame, JMenuBar, JMenu, JMenuItem, ActionListener
A frame class with menus that illustrates the menu action processing.		
Ch14TrackMouseFrame	864	JFrame MouseListener System
This program tracks the mouse click events. When a mouse button is clicked, the location where the mouse button is clicked is displayed.		
Ch14SketchPad	867	JFrame MouseListener MouseMotionListener
This program provides a freehand drawing by tracing the mouse movements.		



CHAPTER 15		
Class Name	Page #	Standard Classes
Ch15Algorithms*	882, 883, 886, 889, 891, 892	
		This class includes a collection of recursive algorithms discussed in Chapter 15.
TestCh15Algorithms**	N/A	
		A driver program for testing algorithms in <b>Ch15Algorithms</b> .

# Appendix C

## Standard Classes and Interfaces

In this appendix, we provide a list of standard Java classes and interfaces used in the textbook's sample programs. Many of these classes and interfaces are discussed fully in the book and used extensively in the sample programs, while some are mentioned briefly and used only in a few sample programs. For a subset of these classes and interfaces, we provide a brief summary and a list of key methods.

### Alphabetical List

Standard Java classes and interfaces mentioned in this book are listed alphabetically. The interfaces are shown in italic font.

Alphabetical List		
ActionEvent	Double	InputStreamReader
<i>ActionListener</i>	Exception	Integer
ArrayList	File	IOException
Arrays	FileFilter	ItemEvent
BorderFactory	FileInputStream	<i>ItemListener</i>
BorderLayout	FileNotFoundException	JButton
BufferedReader	FileOutputStream	JCheckBox
ChangeEvent	FileReader	JFileChooser
<i>ChangeListener</i>	Float	JFrame
ClassNotFoundException	FlowLayout	JLabel
Color	Graphics	JList
DataInputStream	GregorianCalendar	JMenu
DataOutputStream	GridLayout	JMenuBar
Date	HashMap	JMenuItem
DecimalFormat	IllegalArgumentException	JOptionPane
Dimension	ImageIcon	JPanel

<b>Alphabetical List</b> <i>(Continued)</i>		
JPasswordField	Matcher	PrintWriter
JRadioButton	Math	Random
JRootPane	MouseEvent	Scanner
JScrollPane	<i>MouseListener</i>	<i>Serializable</i>
JSlider	<i>MouseMotionListener</i>	SimpleDateFormat
JTextArea	NumberFormatException	<i>SortedMap</i>
JTextField	ObjectInputStream	StringBuffer
LinkedList	ObjectOutputStream	String
<i>List</i>	Pattern	StringTokenizer
Long	Point	System
<i>Map</i>	PrintStream	TreeMap

## Logical List

The following list organizes the standard classes and interfaces from the alphabetical list in logical groups.

<b>Logical List</b>		
<b>Drawing</b>		
Color	Dimension	Graphics
Point		
<b>Events</b>		
ActionEvent	<i>ActionListener</i>	ChangeEvent
<i>ChangeListener</i>	ItemEvent	<i>ItemListener</i>
MouseEvent	<i>MouseListener</i>	<i>MouseMotionListener</i>
<b>Exceptions</b>		
ClassNotFoundException	Exception	FileNotFoundException
IllegalArgumentException	IOException	NumberFormatException
<b>File Input and Output</b>		
BufferedReader	DataInputStream	DataOutputStream
File	FileFilter	FileInputStream

<b>Logical List</b> <i>(Continued)</i>		
FileOutputStream	FileReader	InputStreamReader
ObjectInputStream	ObjectOutputStream	PrintStream
PrintWriter	<i>Serializable</i>	
<b>GUI</b>		
BorderFactory	BorderLayout	FlowLayout
GridLayout	ImageIcon	JButton
JCheckBox	JFileChooser	JFrame
JLabel	JList	JMenu
JMenuBar	JMenuItem	JOptionPane
JPanel	JPasswordField	JRadioButton
JRootPane	JScrollPane	JSlider
JTextArea	JTextField	
<b>Java Collection Framework</b>		
ArrayList	HashMap	LinkedList
<i>List</i>	<i>Map</i>	<i>SortedMap</i>
TreeMap		
<b>Utility</b>		
Arrays	Date	DecimalFormat
GregorianCalendar	Matcher	Math
Pattern	Random	Scanner
SimpleDateFormat	StringBuffer	String
StringTokenizer	System	
<b>Wrapper</b>		
Double	Float	Integer
Long		

## Class Hierarchy for Swing Components

Many of the methods we use for various Swing-based components are defined in the common superclass. Instead of repeating the same information in individual classes, we will list the methods in the class in which they are defined. Here is the inheritance hierarchy for the Swing components mentioned in the book (classes

summarized in the next section are shown in blue):

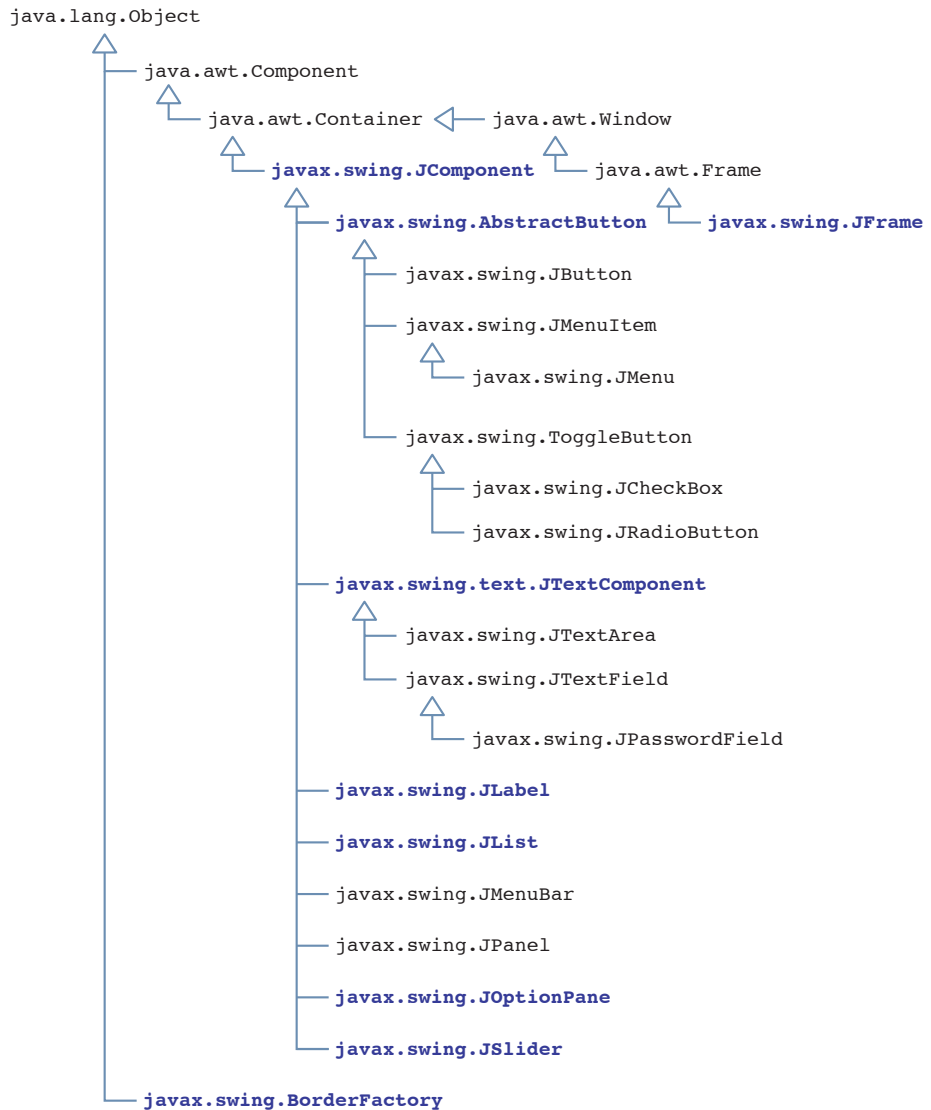

## Summary of Selected Classes and Interfaces

In this section, we summarize a subset of standard classes and interfaces mentioned in the book. The classes and interfaces are listed in alphabetical order. For each class and interface we summarize, we include a brief description and some of its methods. The summary is intended as a quick reference. It is not a substitute for the API documentation. For a complete list of methods and full description, please consult the API documentation.

<b>Class:</b> <code>javax.swing.AbstractButton</code>	
<b>Purpose:</b>	This is the base class of button and menu objects. Methods defined here are applicable to all subclasses.
<b>Hierarchy:</b>	<pre> java.lang.Object ← java.awt.Component ← java.awt.Container ← javax.swing.JComponent ← javax.swing.AbstractButton </pre>
<b>Subclasses:</b>	<code>JButton</code> , <code>JCheckBox</code> , <code>JRadioButton</code> , <code>JMenuItem</code> , <code>JMenu</code>
<b>Public Methods:</b>	
<code>void ActionListener (ActionListener listener)</code>	Adds <code>listener</code> as an action listener of this button.
<code>String getText ( )</code>	Returns the text of this button.
<code>void setText (string text)</code>	Sets the text of this button.

<b>Class:</b> <code>java.awt.event.ActionEvent</code>	
<b>Purpose:</b>	An instance of this class represents an action event such as clicking a pushbutton or pressing the Enter key while the text field has a focus.
<b>Hierarchy:</b>	<pre> java.lang.Object ← java.util.EventObject ← java.awt.AWTEvent ← java.awt.event.ActionEvent </pre>
<b>Public Methods:</b>	
<code>String getActionCommand( )</code>	Returns a string associated with the event source.
<code>Object getSource( )</code>	Returns the source object that generated an action event.

<b>Interface:</b> <code>java.awt.event.ActionListener</code>	
<b>Purpose:</b>	An instance of this class represents an action event such as clicking a pushbutton or pressing the Enter key while the text field has a focus.
<b>Hierarchy:</b>	<code>java.util.EventListener</code> $\leftarrow$ <code>java.awt.event.ActionListener</code>
<b>Public Methods:</b>	
<code>void actionPerformed(ActionEvent event)</code>	
This method is called when the event source generates an action event. A class that implements this interface must define the <code>actionPerformed</code> method.	

<b>Class:</b> <code>javax.swing.BorderFactory</code>	
<b>Purpose:</b>	This factory class produces various types of borders for GUI components
<b>Hierarchy:</b>	<code>java.lang.Object</code> $\leftarrow$ <code>javax.swing.BorderFactory</code>
<b>Public Methods:</b>	
<code>static Border createBevelBorder (int type, Color highlight, Color shadow)</code>	
Creates a beveled border object of a specified type and colors for highlighting and shadowing. The value for <code>type</code> can be either <code>BevelBorder.LOWERED</code> or <code>BevelBorder.RAISED</code> .	
<code>static Border createEtchedBorder (int type, Color highlight, Color shadow)</code>	
Creates an etched border object of a specified type and colors for highlighting and shadowing. The value for <code>type</code> can be either <code>EtchedBorder.LOWERED</code> or <code>EtchedBorder.RAISED</code> .	
<code>static Border createLineBorder (Color color)</code>	
Creates a line border object in a specified color and default line thickness.	
<code>static Border createLineBorder (Color color, int thickness)</code>	
Creates a line border object in a specified color and line thickness.	

<b>Class:</b> <code>java.util.Date</code>	
<b>Purpose:</b>	This class represents a specific instance in time with millisecond precision.
<b>Hierarchy:</b>	<code>java.lang.Object</code> $\leftarrow$ <code>java.util.Date</code>
<b>Constructors:</b>	
<code>Date ( )</code>	
	Creates a new <code>Date</code> whose value is set to the time instance when it is created.
<b>Public Methods:</b>	
<code>boolean after (Date date)</code>	
	Returns <code>true</code> if this date is after the argument date.
<code>boolean before (Date date)</code>	
	Returns <code>true</code> if this date is before the argument date.
<code>long getTime ( )</code>	
	Returns the elapsed time in milliseconds since the epoch, which is designated as January 1, 1970, 00:00:00 GMT.

<b>Class:</b> <code>java.text.DecimalFormat</code>	
<b>Purpose:</b>	This class is used to format decimal numbers.
<b>Hierarchy:</b>	<code>java.lang.Object</code> $\leftarrow$ <code>java.text.Format</code> $\leftarrow$ <code>java.text.NumberFormat</code> $\leftarrow$ <code>java.text.DecimalFormat</code>
<b>Constructors:</b>	
<code>DecimalFormat (String pattern)</code>	
	Creates a new <code>DecimalFormat</code> initialized to a given pattern.
<b>Public Methods:</b>	
<code>String format (long number)</code>	
<code>String format (double number)</code>	
	Return the formatted string of a given number.



<b>Class:</b> <code>java.io.File</code>	
<b>Purpose:</b>	An instance of this class represents a file or a directory.
<b>Hierarchy:</b>	<code>java.lang.Object</code> $\leftarrow$ <code>java.io.File</code>
<b>Public Constants:</b>	
<code>String pathSeparator</code>	This system-dependent path separator symbol is represented as a string. A path separator for Windows is the semicolon. This value can be retrieved by the statement <code>System.getProperty("path.separator")</code> also.
<code>String separator</code>	This system-dependent file separator symbol is represented as a string. A file separator for Windows is the backslash. This value can be retrieved by the statement <code>System.getProperty("file.separator")</code> also.
<b>Constructors:</b>	
<code>File (String filename)</code>	Creates a <code>File</code> object for a given filename. The filename can be a full path name or a name relative to the current directory.
<b>Public Methods:</b>	
<code>String getAbsolutePath( )</code>	Returns the full path name of this file.
<code>boolean isDirectory( )</code>	Returns <code>true</code> if this <code>File</code> object represents a directory.
<code>boolean isFile( )</code>	Returns <code>true</code> if this <code>File</code> object represents a file.
<code>String[] list( )</code>	Returns an array of file and subdirectory names of this <code>File</code> object representing a directory.

<b>Class:</b> <code>java.util.Formatter</code>	
<b>Purpose:</b>	This class is used to format the numerical and text output with justification and alignment. See Section 6.8 for sample usage.
<b>Hierarchy:</b>	<code>java.lang.Object</code> $\leftarrow$ <code>java.util.Formatter</code>

<b>Class:</b> <code>java.util.Formatter</code> <i>(Continued)</i>
<b>Constructors:</b>
<code>Formatter ( outputStream out )</code>
Creates a Formatter for the specified output stream. Example: <pre>Formatter formatter = new Formatter(System.out);</pre>
<b>Public methods:</b>
<code>Formatter format (String format, Object... expressions)</code>
Formats the given <b>expressions</b> using the formatting pattern <b>format</b> and outputs the result to the associated output stream. Expressions can be numerical, string, <b>GregorianCalendar</b> , and other types of data. The formatting pattern is explained in Section 6.8.
Note: From Java 5.0 (SDK 1.5) <b>System.out</b> ( <b>PrintStream</b> object) and <b>String</b> both support a new method named <b>format</b> that does the formatting. The <b>format</b> method of the <b>String</b> class is a class method that returns the formatted string.

<b>Class:</b> <code>java.awt.Graphics</code>
<b>Purpose:</b> This class supports drawing functionality.
<b>Hierarchy:</b> <code>java.lang.Object</code> $\leftarrow$ <code>java.awt.Graphics</code>
<b>Public Methods:</b>
<code>void drawLine(int x1, int y1, int x2, int y2)</code>
Draws a line between (x1, y1) and (x2, y2).
<code>void drawOval(int x, int y, int width, int height)</code>
Draws an oval.
<code>void drawRect(int x, int y, int width, int height)</code>
Draws a rectangle.
<code>void drawRoundRect(int x, int y, int width, int height, int arcWidth, int arcHeight)</code>
Draws a rectangle with rounded corners

**Class:** `java.awt.Graphics` (Continued)

```
void drawString(String text, int x, int y)
```

Draws a given text at position (x,y).

```
void fillOval(int x, int y, int width, int height)
```

Draws a filled oval.

```
void fillRect(int x, int y, int width, int height)
```

Draws a filled rectangle.

```
void fillRoundRect(int x, int y, int width, int height,
 int arcWidth, int arcHeight)
```

Draws a filled rectangle with rounded corners.

```
void setColor(Color color)
```

Sets the pen color to color.

```
void setFont(Font font)
```

Sets the font to font.

**Class:** `java.util.GregorianCalendar`

**Purpose:** This class represents a specific instance in time using the Gregorian calendar.

**Hierarchy:** `java.lang.Object`  $\leftarrow$  `java.util.Calendar`  $\leftarrow$   
`java.util.GregorianCalendar`

**Public Constants:** A partial list of constants defined in the Calendar class.

```
int DAY_OF_MONTH
int DAY_OF_WEEK
int DAY_OF_WEEK_IN_MONTH
int DAY_OF_YEAR
int HOUR
int HOUR_OF_DAY
int MINUTE
int SECOND
```

See the `Ch3TestCalendar` class for the sample uses of these constants.

<b>Class:</b> <code>java.util.GregorianCalendar</code> <i>(Continued)</i>	
<b>Constructors:</b>	
<code>GregorianCalendar ( )</code>	Creates a new <code>GregorianCalendar</code> set to the time and date of the system clock when this object is created.
<code>GregorianCalendar (int year, int month, int day)</code>	Creates a new <code>GregorianCalendar</code> set to the argument year, month, and day. Notice the month ranges from 0 to 11.
<code>GregorianCalendar (int year, int month, int day, int hour, int minute)</code>	Creates a new <code>GregorianCalendar</code> set to the argument values.
<code>GregorianCalendar (int year, int month, int day, int hour, int minute, int second)</code>	Creates a new <code>GregorianCalendar</code> set to the argument values.
<b>Public Methods:</b>	
<code>int get (int field)</code>	Returns the specified field's value. See the class constants for the possible fields.
<code>Date getTime ( )</code>	Returns this object represented as a <code>Date</code> .
<code>long getTime ( )</code>	Returns the elapsed time in milliseconds since the epoch, which is designated as January 1, 1970, 00:00:00 GMT.

<b>Class:</b> <code>javax.swing.JComponent</code>	
<b>Purpose:</b>	This is the base class of all Swing GUI components such as buttons, text fields, menus, and others. Methods defined here are applicable to all subclasses.
<b>Hierarchy:</b>	<code>java.lang.Object</code> $\leftarrow$ <code>java.awt.Component</code> $\leftarrow$ <code>java.awt.Container</code> $\leftarrow$ <code>javax.swing.JComponent</code>

**Class:** `javax.swing.JComponent` (Continued)**Public Methods:**

`JRootPane getRootPane ( )`

Returns the root pane that contains this component.

`void setBackground (Color color)`

Sets the background of this component to `color`.

`void setBorder (Border border)`

Sets the border of this component to `border`.

`void setEnabled (boolean state)`

Enables this component if `state` is `true` and disables it if `state` is `false`.

`void setFont (Font font)`

Sets the font used for this component to `font`.

`void setForeground (Color color)`

Sets the foreground of this component to `color`. This is how you change the text color of a component.

`void setVisible (boolean state)`

Makes this component visible if `state` is `true` and invisible if `state` is `false`.

**Class:** `javax.swing.JFrame`

**Purpose:** This class is the extended version of `java.awt.Frame` that works as a container for Swing GUI components.

**Hierarchy:**

```

java.lang.Object <|-- java.awt.Component <|--
java.awt.Container <|-- java.awt.Window <|--
java.awt.Frame <|-- javax.swing.JFrame

```

<b>Class:</b> <code>javax.swing.JFrame</code> <i>(Continued)</i>
<b>Constructors:</b>
<code>JFrame ( )</code>
Creates a new <code>JFrame</code> initialized to default properties.
<code>JFrame (String title)</code>
Creates a new <code>JFrame</code> with a specified title and default values for other properties.
<b>Public Methods:</b>
<code>Container getContentPane ( )</code>
Returns the content pane of this frame.
<code>void resizable (boolean state)</code>
Enables the resizing of this frame if <code>state</code> is <code>true</code> and disables the resizing if <code>state</code> is <code>false</code> .
<code>void getContentPane (Container pane)</code>
Sets the content pane of this frame. You can pass an instance of <code>JPanel</code> as an argument.
<code>void setJMenuBar (JMenuBar menubar)</code>
Sets the menu bar of this frame.
<code>void setBounds (int x, int y, int width, int height)</code>
Sets the origin point of this frame to $(x,y)$ , width to <code>width</code> , and height to <code>height</code> .
<code>void setLocation (int x, int y)</code>
Sets the origin point of this frame to $(x,y)$ .
<code>void setSize (int width, int height)</code>
Sets the width to <code>width</code> and height to <code>height</code> .
<code>void setTitle (String title)</code>
Sets the title of this frame.
<code>void setVisible (boolean state)</code>
Makes this frame visible if <code>state</code> is <code>true</code> and invisible if <code>state</code> is <code>false</code> .

<b>Class:</b> <code>javax.swing.JLabel</code>	
<b>Purpose:</b>	An instance of this class is used to display uneditable text or image (or both).
<b>Hierarchy:</b>	<pre> java.lang.Object &lt; -- java.awt.Component &lt; -- java.awt.Container &lt; -- javax.swing.JComponent &lt; -- javax.swing.JLabel </pre>
<b>Constructors:</b>	
<code>JLabel ( )</code>	Creates a new JLabel initialized to an empty image and text.
<code>JLabel (Icon icon)</code>	Creates a new JLabel with the specified image. Note that Icon is an interface, and the ImageIcon class implements this interface, so you can pass an ImageIcon object as an argument.
<code>JLabel (String text)</code>	Creates a new JLabel with the specified text.
<b>Public Methods:</b>	
<code>Icon getIcon ( )</code>	Returns the icon of this label.
<code>String getText ( )</code>	Returns the text of this label.
<code>void setIcon (Icon icon)</code>	Sets the icon of this label.
<code>void setText (String text)</code>	Sets the text of this label. The argument should be a single line of text. Any text after the new-line character is ignored.

<b>Class:</b> <code>javax.swing.JList</code>	
<b>Purpose:</b>	This component represents a list box.
<b>Hierarchy:</b>	<pre> java.lang.Object &lt; -- java.awt.Component &lt; -- java.awt.Container &lt; -- javax.swing.JComponent &lt; -- javax.swing.JList </pre>

<b>Class:</b> <code>javax.swing.JList</code> (Continued)
<b>Constructors:</b>
<code>JList (Object[] list)</code>
Creates a new <code>JList</code> with its items set to the passed array elements.
<b>Public Methods:</b>
<code>int getSelectedIndex ( )</code>
Returns the index of the first selected items. If no item is selected, then -1 is returned.
<code>int[] getSelectedIndices ( )</code>
Returns an array of indices of all selected items.
<code>void setSelectionMode (int mode)</code>
Sets the selection mode of this list to mode. The three possible values for mode are <code>ListSelectionMode.SINGLE_SELECTION</code> , <code>ListSelectionMode.SINGLE_INTERVAL_SELECTION</code> , and <code>ListSelectionMode.MULTIPLE_INTERVAL_SELECTION</code> . The default mode is <code>ListSelectionMode.MULTIPLE_INTERVAL_SELECTION</code> .

<b>Class:</b> <code>javax.swing.JOptionPane</code>
<b>Purpose:</b> This is a convenience class that supports a quick and easy way to deal with a standard dialog box for displaying short messages or getting an input value.
<b>Hierarchy:</b> <code>java.lang.Object</code> $\leftarrow$ <code>java.awt.Component</code> $\leftarrow$ <code>java.awt.Container</code> $\leftarrow$ <code>javax.swing.JComponent</code> $\leftarrow$ <code>javax.swing.JOptionPane</code>
<b>Public Constants:</b> This is a partial list. <code>int YES_OPTION</code> <code>int NO_OPTION</code> <code>int CANCEL_OPTION</code> <code>int OK_OPTION</code> <code>int YES_NO_CANCEL_OPTION</code>
<b>Public Methods:</b> Note the listed methods are all class methods.
<code>static int showConfirmDialog (Component parent, Object message)</code>
Displays a standard confirmation dialog and returns the value to indicate which button (Yes, No, or Cancel) is clicked.



**Class: javax.swing.JOptionPane** *(Continued)*

```
static int showConfirmDialog (Component parent, Object message,
 String title, int optionType)
```

Displays a confirmation dialog with `message` as its prompt and `title` as the dialog title. The value of `optionType` determines which buttons are shown in the dialog.

```
static String showInputDialog (Component parent, Object message)
```

Displays a standard input dialog and returns the entered value as a `String`.

```
static void showMessageDialog (Component parent, Object message)
```

Displays a standard message dialog with the text message.

**Class: javax.swing.JSlider**

**Purpose:** This component represents a slider.

**Hierarchy:** `java.lang.Object` ← `java.awt.Component` ←  
`java.awt.Container` ← `javax.swing.JComponent` ←  
`javax.swing.JSlider`

**Constructors:**

```
JSlider ()
```

Creates a new horizontal slider ranging from 0 to 100. The initial position of the slider knob is set to 50.

```
JSlider (int min, int max)
```

Creates a new horizontal slider ranging from `min` to `max`. The initial position of the slider knob is set to the average of `min` and `max`.

```
JSlider (int orientation, int min, int max, int value)
```

Creates a new slider ranging in values from `min` to `max`. The initial position of the slider knob is set to `value`, and the orientation to `orientation` (`JSlider.VERTICAL` or `JSlider.HORIZONTAL`).

**Public Methods:**

```
int getValue ()
```

Returns the current value of this slider.

<b>Class:</b> <code>javax.swing.JSlider</code> (Continued)	
<code>void setMajorTickSpacing (int spacing)</code>	Sets the major tick spacing to <code>spacing</code> .
<code>void setMaximum (int max)</code>	Sets the maximum to <code>max</code> .
<code>void setMinimum (int min)</code>	Sets the minimum to <code>min</code> .
<code>void setMinorTickSpacing (int spacing)</code>	Sets the minor tick spacing to <code>spacing</code> .
<code>void setPaintLabels (boolean state)</code>	Draws the labels if <code>state</code> is <code>true</code> .
<code>void setPaintTicks (boolean state)</code>	Draws the tick marks if <code>state</code> is <code>true</code> .
<code>void setValue (int value)</code>	Sets the current value of this slider to <code>value</code> .

<b>Class:</b> <code>javax.swing.JTextComponent</code>	
<b>Purpose:</b>	An instance of this class is used to display uneditable text or image (or both).
<b>Hierarchy:</b>	<code>java.lang.Object</code> $\leftarrow$ <code>java.awt.Component</code> $\leftarrow$ <code>java.awt.Container</code> $\leftarrow$ <code>javax.swing.JComponent</code> $\leftarrow$ <code>javax.swing.JTextComponent</code>
<b>Constructors:</b>	They use the constructors of the subclasses <code>JTextArea</code> and <code>JTextField</code> .
<b>Public Methods:</b>	
<code>String getSelectedText ( )</code>	Returns the selected text of this text component.
<code>String getText ( )</code>	Returns the text of this text component.

**Class:** `javax.swing.JTextComponent` (Continued)

`void setEditable (boolean state)`

Makes this text component editable if `state` is `true` and an editable if `state` is `false`.

`void setText (String str)`

Sets the text of this text component to a specified `str`.

**Class:** `java.lang.Math`

**Purpose:** This class supports mathematical functions.

**Hierarchy:** `java.lang.Object`  $\leftarrow$  `java.awt.Graphics`

**Public Constants:**

`double PI`

The value of pi.

`double E`

The value of natural number *e*.

**Public Methods:** Please refer to Table 3.6 for a list of methods.

**Class:** `java.util.Random`

**Purpose:** An object to generate random numbers.

**Hierarchy:** `java.lang.Object`  $\leftarrow$  `java.util.Random`

**Constructors:**

`Random ( )`

Creates a new random number generator.

**Public methods:**

`int nextInt( )`

Returns a pseudorandom **int** value.

`int nextInt(int N)`

Returns a pseudorandom **int** value between 0 (inclusive) and N (exclusive).

<b>Class:</b> <code>java.util.Scanner</code>
<b>Purpose:</b> An object to input data from an input stream.
<b>Hierarchy:</b> <code>java.lang.Object</code> $\leftarrow$ <code>java.util.Scanner</code>
<b>Constructors:</b>
<code>Scanner ( InputStream source )</code> Creates a new <b>Scanner</b> with input values coming from the <b>source</b> . Example: <code>Scanner scanner = new Scanner(System.in);</code>
<b>Public methods:</b>
<code>byte nextByte( )</code> Returns the next input value as a <b>byte</b> .
<code>double nextDouble( )</code> Returns the next input value as a <b>double</b> .
<code>float nextFloat( )</code> Returns the next input value as a <b>float</b> .
<code>int nextInt( )</code> Returns the next input value as a <b>int</b> .
<code>long nextLong( )</code> Returns the next input value as a <b>long</b> .
<code>short nextShort( )</code> Returns the next input value as a <b>short</b> .
<code>String next( )</code> Returns the next input value as a <b>String</b> .
<code>void useDelimiter(String marker)</code> Sets <b>marker</b> as a marker to separate the input values. Useful when reading a text that contains spaces. Example: To set the tab as the separator, write <code>scanner.useDelimiter("\t");</code>

<b>Class:</b> <code>java.text.SimpleDateFormat</code>	
<b>Purpose:</b>	This class is used to format dates.
<b>Hierarchy:</b>	<code>java.lang.Object</code> $\leftarrow$ <code>java.text.Format</code> $\leftarrow$ <code>java.text.DateFormat</code> $\leftarrow$ <code>java.text.SimpleDateFormat</code>
<b>Constructors:</b>	
<code>SimpleDateFormat ( )</code>	
	Creates a new <code>SimpleDateFormat</code> initialized to a default format.
<code>SimpleDateFormat (String format)</code>	
	Creates a new <code>SimpleDateFormat</code> initialized to the specified format. See Table 2.1 for the symbols you can use to specify the format.
<b>Public Methods:</b>	
<code>String format (Date date)</code>	
	Returns the formatted string of a given date.

<b>Class:</b> <code>java.lang.String</code>	
<b>Purpose:</b>	This class represents an immutable sequence of characters.
<b>Hierarchy:</b>	<code>java.lang.Object</code> $\leftarrow$ <code>java.lang.String</code>
<b>Constructors:</b>	
<code>String ( )</code>	
	Creates a new empty <code>String</code> .
<code>String (String str)</code>	
	Creates a new <code>String</code> from a given <code>str</code> .
<b>Public Methods:</b>	
<code>char charAt (int index)</code>	
	Returns a character at position <code>index</code> . The first character in a string is at position 0.

<b>Class:</b> <code>java.lang.String</code> (Continued)
<code>String concat(String str)</code>
Returns a new string that is a concatenation of this string and the argument <code>str</code> . The concatenation operator <code>+</code> is equivalent to this method.
<code>boolean equals(String str)</code>
Returns <code>true</code> if this string has the same sequence of characters as the argument <code>str</code> . Comparison is done in a case-sensitive manner.
<code>boolean equalsIgnoreCase(String str)</code>
Is the same as <code>equals</code> but in a case-insensitive manner.
<code>static String format(String format, Object... expressions)</code>
Formats the given <code>expressions</code> following the formatting pattern <code>format</code> and returns the formatted string.
<code>int length()</code>
Returns the number of characters in this string.
<code>boolean matches(String regex)</code>
Returns <code>true</code> if this string matches the given regular expression <code>regex</code> .
<code>String substring(int start)</code>
Returns a substring of this string from index position <code>start</code> to the last character of this string.
<code>String substring(int start, int end)</code>
Returns a substring of this string from index position <code>start</code> to <code>end-1</code> .
<code>String toLowerCase()</code>
Converts this string to all lowercase characters.
<code>String toUpperCase()</code>
Converts this string to all uppercase characters.
<code>String trim()</code>
Removes the leading and trailing whitespaces (e.g., blank spaces, tabs, new lines).

<b>Class:</b> <code>java.lang.StringBuffer</code>	
<b>Purpose:</b>	This class represents a mutable sequence of characters.
<b>Hierarchy:</b>	<code>java.lang.Object</code> $\leftarrow$ <code>java.lang.StringBuffer</code>
<b>Constructors:</b>	
<code>StringBuffer ( )</code>	Creates a new empty <code>StringBuffer</code> with the initial capacity of 16 characters.
<code>StringBuffer (String str)</code>	Creates a new <code>StringBuffer</code> whose content is initialized to a given <code>str</code> .
<b>Public Methods:</b>	
<code>StringBuffer append (char ch)</code> <code>StringBuffer append (String str)</code>	Appends an argument to this string buffer.
<code>char charAt(int index)</code>	Returns a character at position <code>index</code> . The first character in a string is at position 0.
<code>StringBuffer deleteCharAt(int index)</code>	Removes the character at position <code>index</code> from this string buffer.
<code>StringBuffer insert (int index, char ch)</code> <code>StringBuffer insert (int index, String str)</code>	Inserts an argument to this string buffer at position <code>index</code> .
<code>int length()</code>	Returns the number of characters in this string.
<code>StringBuffer reverse( )</code>	Reverses this string buffer.
<code>String substring(int start)</code>	Returns a substring of this string buffer from index position <code>start</code> to the last character of this string.
<code>String substring(int start, int end)</code>	Returns a substring of this string buffer from index position <code>start</code> to <code>end-1</code> .

# Appendix D

## UML Diagrams

### What is UML?

The unified modeling language (UML) provides graphical notation to model computer systems that are developed by using object-oriented software engineering (OOSE). The focus of OOSE is identifying the problem elements that produce or consume information and describing the relationships among these elements. In OOSE, objects are defined to represent these elements during the system analysis and design process. UML diagrams allow software engineers to indicate the relationships among the objects used to define the system. Most of these objects will need to be implemented using software in the final system. UML is particularly useful when the plan is to implement the system in an object-oriented language like Java.

Software engineers use several types of models during the analysis and design phases of the software development process. Data models describe object attributes and relationships with each other. Functional models show how data is transformed as it flows through the system. Behavioral models depict the actions taken by the system in response to events. Architectural diagrams show the relationships among the hardware and software components needed to implement the complete system. UML provides several types of diagrams to support the modeling needs of software engineers. We use a subset of the UML class diagram notation to describe the design of sample programs in this textbook.

In this appendix, we will describe and illustrate the use of UML diagrams by modeling the attributes, behavior, and architecture of a simple vending machine. This vending machine accepts a single coin and dispenses a single product. The machine does not give change. If a bad coin is inserted, or if the machine has no product to dispense, the coin will be returned to the customer. A merchant owns the machine and adds products to it. The merchant also removes the coins from the coin box.

### Class Diagram

Class diagrams are one of the most important UML diagrams used by software engineers. Class diagrams are used to create logical models of computer-based systems. A class diagram shows class structure, contents, and the static relationships among the classes used to model a system. These relationships are known as associations and are drawn as lines connecting the related graph nodes. Each node in a class diagram is labeled with its class name. The class node may also contain lists



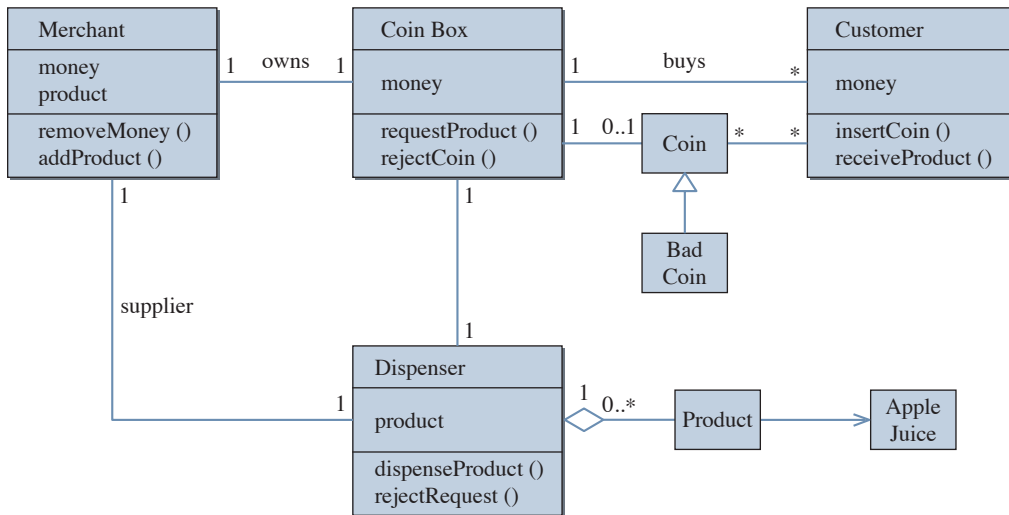

**Figure 1** Class diagram.

of data attributes and method prototypes. The visibility of attributes or methods can be indicated by prefixing their names with a + (public) or - (private).

An association line indicates that there is a linkage between two classes. Some associations may be labeled with a string indicating the type of relationship between the classes. Each end of the association is labeled with a number, \*, or range to describe the multiplicity of the link (e.g., 1..\* designates a multiplicity that ranges from 1 to many). Part-whole relationships (known as aggregations in UML) are indicated using an open diamond at one end of the link. Inheritance relationships (known as generalizations in UML) are indicated using an open triangle to point to the appropriate super class. Class instances are shown drawing an arrow-head pointing to a class instance node.

## Use Case Diagram

Use case diagrams are used to model system functional requirements. These diagrams show how users interact with the system. They are drawn to be independent of the specific user interface design that will be used in the final system. Use cases summarize several scenarios for a user task or goal. A scenario is an instance of an instance of use case for a particular actor, at a specific time, with specific data. Each scenario would be described using text description and shown graphically with a sequence diagram. Use case diagrams assist software engineers to develop test cases.

Users are called actors and are represented in use case diagrams by labeled stick figures. Use case nodes are labeled with user goals or tasks. Actors are connected to the appropriate nodes using lines. Links may be labeled with the string «extends» to show explicitly optional actor interactions or handling of exceptional

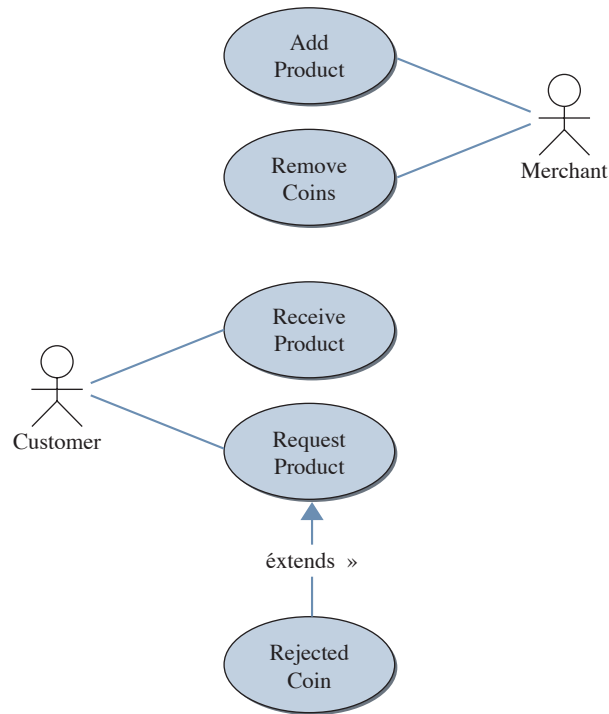

**Figure 2** Use case diagram.

uses. The string «uses» may be used to label links to existing use cases being used as subsystems in the current use case. Each path through a use case diagram represents a separate use case.

## Sequence Diagram

Sequence diagrams model system behavior for use cases by showing the necessary class interactions. Sequence diagrams depict workflow from a use case graphically. They show the temporal sequence of message exchanges among a collection of objects as they communicate to achieve a specific task. In particular they show how the user (actor) interacts with a system to get work done (i.e., what messages get sent and when are they sent). The events modeled in sequence diagrams are external events initiated by an actor.

The actors and objects are arranged horizontally across the top of the diagram. The vertical dimension represents time. A vertical line called a lifeline is attached to each actor or object. The lifeline becomes an activation box to show the live activation period of the object or actor. A message is represented using an arrow labeled with a message. The message label may contain an argument list and a return type. Dashed arrows may be used to indicate object flow. If an object's

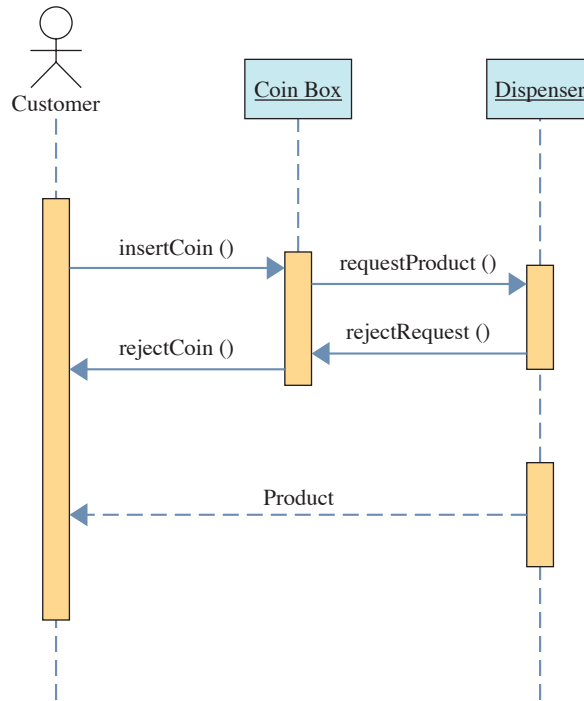

**Figure 3** Sequence diagram.

life ends during the execution of the use case an X is placed at the bottom of its lifeline.

### Collaboration Diagram

Collaboration diagrams show the message passing structure of the system. The focus is on the roles of the objects as they interact to realize a system function. They can be used to represent portions of a design pattern and are useful for validating class diagrams.

A collaboration diagram is a directed graph with the objects and actors as vertices. Directional links are used to indicate communication between objects. These

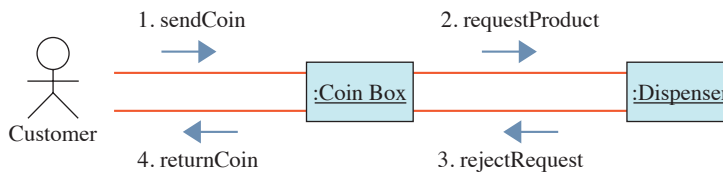

**Figure 4** Return coin collaboration diagram.

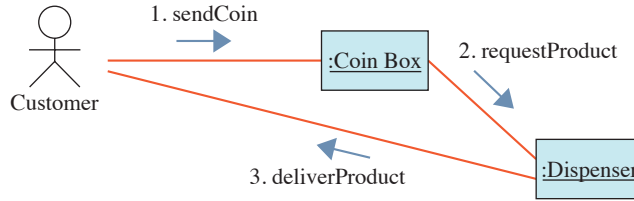
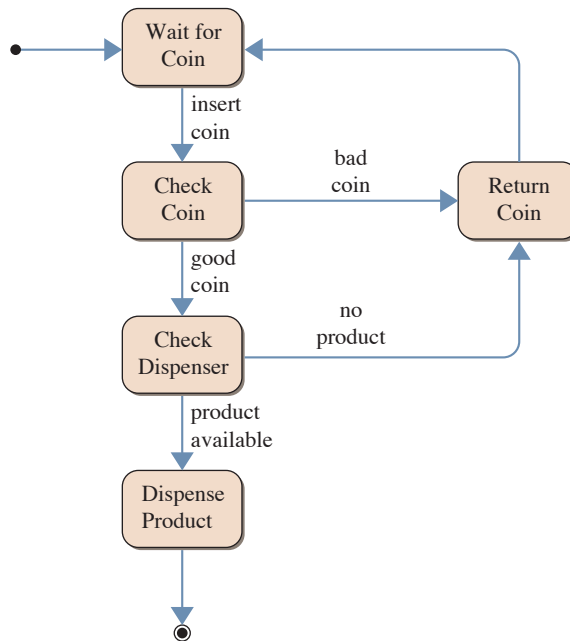

**Figure 5** Product delivery collaboration diagram.

links are labeled using appropriate messages. Each message is prefixed with a sequence number to indicate the time ordering required to complete the system function. As you can see in Figure 5, not every collaboration diagram can be drawn horizontally or vertically.

### State Diagram

State diagrams describe the behavior of a system, subsystem, or an individual object. The system state is determined by the values assigned to object attributes. A system is assumed to remain in its current state until some new event occurs. State diagrams show changes in system state or object attributes in response to external



**Figure 6** State diagram.

events or triggers. They can display the sequence of states an object goes through in response to potential triggers.

A state diagram is a directed graph whose nodes are labeled with state names. The nodes in a state diagram are drawn as rectangles with rounded corners. The links between the nodes are called transitions and are labeled with the name of the triggering event. A small black circle is used to represent the start state. A small black circle with a ring around it is used to represent the end state. Enclosing a group of nodes in the state diagram with a rectangle having rounded corners can be done to identify a substate.

## Activity Diagram

Activity diagrams show the workflow that an object or system component performs. They can show both data flow (information exchange) and control flow (operation ordering). Activities are states representing the execution of a set of operations or thread needed to realize a system function. The transitions to new activities are triggered by the completion of the current activity. Activity diagrams are similar to

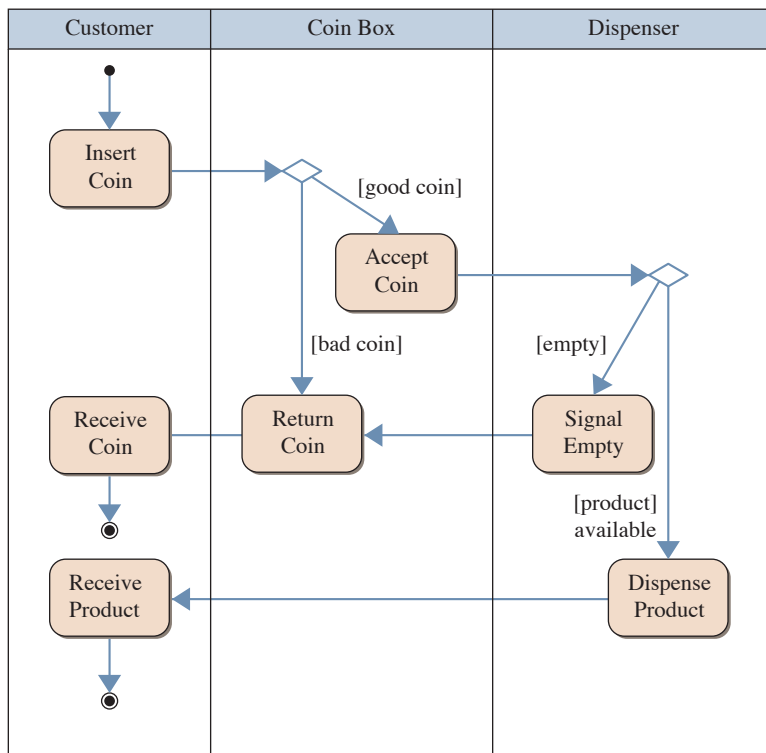

**Figure 7** Activity diagram.

state diagrams except that transitions are triggered by internal events. Internal events are not visible to the system user. Activity diagrams can be used to visualize the interrelations and interactions between different use cases. Activity diagrams are usually associated with several classes.

Object responsibilities can be shown in an activity diagram by drawing swim lanes labeled with object names. Activity nodes are drawn using rectangles having semicircles on each end. The start and end state symbols are the same as those used in state diagrams. Links may be labeled with conditions that are the result of completing an activity. Decision points may be represented using unlabeled diamonds. Activity diagrams can be used to show concurrent operations like fork, join, and rendezvous.

## Component Diagram

Component diagrams show the relationships (i.e. dependencies, communication, location, and interfaces) among the software building blocks or components in a system. The component diagram might be described as a physical analog of the system class diagram. It is typically made up of several classes and shows the high level code structure of the system.

Each system component is represented as a rectangle with tabs. A component interface is represented using a small round circle connected to a component by a line. An interface describes a group of operations used or created by a component. Arrows can be used to show the direction of information flow. Dashed lines can be used to indicate dependencies among components.

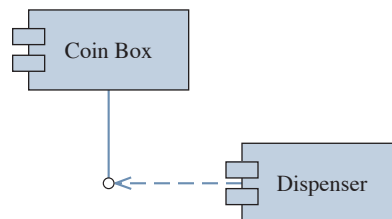

**Figure 8** Component diagram.

## Deployment Diagram

Deployment diagrams depict the physical resources for a system including nodes, components, and connections. Deployment diagrams show the relationships among both hardware and software components. They can also show the configuration or deployment of run-time elements, software components, processes, and objects. Often component diagrams are combined in a single system deployment diagram.

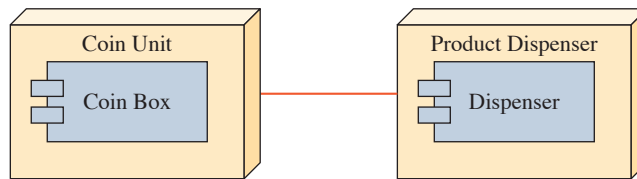

**Figure 9** Deployment diagram.

Nodes in a deployment diagram are typically capable of executing code components and are represented by 3D drawings of boxes. Associations between two nodes are drawn as lines to represent physical connections (e.g., Ethernet) between the nodes.

# Index

## A

- Absolute positioning, 800, 827
- Abstract classes, 753–755
- Abstract methods, 597, 753–757
- Abstract superclasses, 753–757
- AbstractButton class, 937
- Acceleration of gravity. *See* Gravitational constant, computing
- Accessibility
  - inheritance and member, 744–749
  - modifier, 156
- Accessor methods, 158
- Account class, 162–166, 173–177, 183, 191, 244–246
- Account objects, 20–21, 23, 33, 155, 162–163, 175
- Acrobat Reader, 497
- Action events, 802
- ActionEvent class, 858, 937
- ActionEvent object, 803
- ActionListener class, 802, 938
- actionPerformed method, 803, 808, 810, 858
- Activity diagrams, 960–961
- Actual parameter, 167
- add method, 162, 164, 195, 375, 379–381, 383–384, 387–388, 393, 406, 828–829
  - defined, 615–616
  - implementation of, 613–618
  - tests within, 238
- addActionListener method, 808
- Addition operators, 96
- AddressBook class, 609, 628
  - adding sorting routine to, 667
  - program for sorting, 659–679
  - sample development, 609–625
- AddressBook objects, saving, 716–724
- AddressBook program, 716–724
  - sorting, 659–679
- AddressBookStorage objects, 717, 719–720
- adjust method, 195
- Age on other planets, computing, 143–144
- AgeComparator class, 673
- AgeInputException class, 469–470
- Aiken, Howard, 3
- Algorithms
  - Anagram, 885–888
  - Directory listing, 883–885
  - Euclidean, 311, 345
  - heapsort, 648, 651
  - pseudocode representation of, 340
  - Quicksort, 890–895
  - recursive, 881–901
  - sorting, 638–639
  - Towers of Hanoi, 888–890
- Alignment, of values, 335
- Allocation. *See* Memory
- Alternatives. *See* Design alternatives
- ALU. *See* Arithmetic-logic unit
- American Standard Code for Information Interchange. *See* ASCII
- Anagrams, listing, 885–888
- Analysis phase, 25
- Analytical Engine, 2
- Ancestors, 23, 742
- AND operators, 239–240, 242
  - Java symbols for, 242
- API. *See* Application programming interface; Java reference manuals



- append method, 527–528, 816
  - Applets, 12
  - Application programming interface (API), 53
  - Applications, 12
    - Java, 30–52
  - Architecture, computer, 4–10
  - Areas, computing, 218
  - Arguments, 167
    - matching with parameters, 166–168
    - of a message, 19
  - Arithmetic, modulo, 311
  - Arithmetic exceptions, 241
  - Arithmetic expressions, 94–99
    - complex, 96
    - data types of, 254
  - Arithmetic-logic unit (ALU), 8
  - Arithmetic operators, 94
    - addition, 94, 96
    - assignment, 98–99
    - integer division, 94
    - modulo division, 94
    - multiplication, 94, 96
    - parentheses, 96–97
    - precedence, rules for, 95–96, 243
    - subtraction, 94
    - type cast, 97
  - Arithmetic promotion, 96
  - Array elements, 558
    - accessing, 590
    - assigning, 562
    - initializing, 562
    - packing, 575
    - removing, 621
  - Array overflow, 596–597
  - ArrayList class, 427, 597–598, 604, 759
  - Arrays, 555–632. *See also* Subarrays
    - arrays of, 593–594
    - basics of, 556–567
    - and bytes, 695
    - declaring, 557, 565–566
    - defined, 557
    - deletion operation for, 575–576
    - dimensions of, 596
    - multiple, 597
    - of objects, 567–577
    - one-dimensional, 589
      - partitioning, 891–895
      - passing to methods, 582–588
      - sorting, 635–636
      - specifying size of, 610
      - storing size of, 714
      - terminating condition for, 572
      - two-dimensional, 589–596
  - Arrays class, 672–674, 677–678
  - ASCII (American Standard Code for Information Interchange) coding scheme, 496–498, 507, 548, 554, 702
    - expressing in integers, 498
  - Assembly code, 11
  - Assembly languages, 11
  - assert (reserved word), 472–473
  - assert statements, 493, 616
  - AssertionError class, 472
  - Assertions, 445–494, 641
    - control-flow invariants, 474–475
    - differentiating from exceptions, 475–476
    - postcondition, 474
    - precondition, 474
  - Assignment conversions, 98
  - Assignment operators, 98–99
    - evaluating, 99
    - shorthand, 98
  - Assignment statements, 89–94
    - invalid, 141
    - syntax for, 89
    - writing, 101
  - Associations, among UML-based class diagrams, 955
  - Associativity rules, 688
  - Asterisk (\*) notation, 40, 45–46
  - Atanasoff, John, 2
  - AT&T Bell Labs, 12
  - @author tag, 404–405
  - Auto boxing/unboxing, 603–604
  - Automatic Sequence-Controlled Calculator, 3
  - Average age, computing, 570
  - Avoidable tests, 316–317
  - AWT button class, 788–790
- B**
- Babbage, Charles, 2–3
  - Backslash (\) symbols, 516–517, 687

- badMethod, 587
  - Bank deposits and withdrawals, 472–474
  - BankAccount class, 472, 474
  - Barcode readers, 8
  - Base 2 numbers, 6
    - scientific notation in, 138–139
  - Base 10 numbers, scientific notation in, 138
  - Base classes, 23, 735
  - 10BaseT, 10
  - BASIC (programming language), 11–12
  - beginIdx, 507, 509
  - Bell Labs, 11
  - Berry, Clifford, 2
  - Bicycle class, 152–162, 197–198, 389–390
  - Bicycle objects, 152, 155
  - BicycleRegistration class, 154
    - compiling and running, 160–162
  - Binary files, 702
  - Binary number system, 3, 4–7, 136–139
  - Binary operators, 95, 96
  - Binary searching, 634–638
  - Binary-to-decimal conversion, 6
  - binarySearch method, 637
  - Bioinformatics, string processing and, 529–532
  - Bits, 6–7, 496–499
    - sign, 137
  - Bits per second (bps), 10
  - Blocks of code, 43
  - Body Mass Index (BMI), computing, 143
  - BookTracker class, 419–423, 427–429, 604
  - boolean data type, 93, 242, 244
  - Boolean expressions, 223–224, 231, 239–247, 304
    - evaluating, 295
    - modifying, 305
    - order of comparisons in, 505
    - relational operators in, 223–224
    - shortening, 502
  - Boolean flags, 243
  - Boolean operators, 239–240. *See also* Arithmetic operators
    - precedence rules for, 243
  - Boolean variables, and loops, 321
  - BorderFactory class, 815, 938
  - BorderLayout objects, 823–824, 833
  - Bottom-up development, 200
  - Bounding rectangle, 263
  - bps. *See* Bits per second
  - Braces ( { } ), 225
    - not using, 234
  - Brackets. *See* Square brackets ( [ ] )
  - Branching statements, 224. *See also* Selection statements
  - break statements, 254, 323
  - Bubble sort algorithm, 682
  - bubbleSort method, 643–646
    - first pass in, 644
  - BufferedReader objects, 704, 706–707, 709, 761, 771
  - Buffers, data, 696
  - build method, 540, 542–544
    - stub, 542
  - buildRoster method, 771, 779
  - Button events, handling, 802–806
  - ButtonHandler class, 803, 805
  - ButtonHandler objects, 810
  - Buttons. *See also* Pushbuttons
    - placing on a frame, 799–801
    - radio, 839, 844–845
  - byte data type, 87–93, 97, 254
  - byteArray, 697
  - Bytecode, 50
    - files in, 50, 52
  - Bytes, 7, 496–498, 695
    - arrays of, 695
- ## C
- C (programming language), 12, 338, 566
  - C++ (programming language), 12, 338
  - Caching data, 696
  - Caesar cipher, 552–553
  - Calculator program, 877
  - Calendar, online story about, 124
  - Calendar class, 120–123
  - Call-by-value scheme, 202, 395–397, 400
  - Calling methods, 37–38
    - of the same class, 193–197
  - Calories needed, 142
  - Carpet price table, 338
  - case labels, for switch statements, 269–270
  - Casting conversions, 96
    - explicit, 96–97
    - implicit, 96–97

- catch blocks, 449–451, 453–459. *See also* try-catch blocks
  - multiple, 454, 456
- Catching exceptions, 446–453
- CDManager class, 759
- CDs. *See* Compact disks
- Cells, 8, 11
- centerPoint variable, 278, 283
- Central processing unit (CPU), 4, 8–9, 11
- change method, 400–401
- ChangeEvent, 854
- ChangeListener interface, 854
- char data type, 93, 254, 496
- Character class, 549
- Characters, 496–499
- charAt method, 499–500
- Check-box buttons, 839
- Children of a node. *See* Sibling classes
- Circle class, 103–112, 228–232
  - testing the functionality of, 231
- class (reserved word), 46
- Class constants, 23, 115, 183–191
  - declaring public, 182
- Class data values, 20–23
- Class declarations, 18, 46–47, 113–114, 238, 391–395
  - finalizing, 212–213
  - syntax for, 46
- Class definitions, 17
- Class diagrams, UML-based, 35, 955–956
  - associations among, 955
- Class documentation, using Javadoc comments for, 403–408
- Class hierarchy, for swing components, 935–936
- Class instances, declaring private, 182
- Class member declarations, 46–47
- Class methods, 18, 113–114, 391–403
  - declaring private, 182
- Class names, 78. *See also* Identifiers; Naming
- Class variables, 23, 391–395
- Classes, 16–18. *See also* Instantiable classes; Packages; Predefined classes; Subclasses; Superclasses
  - abstract, 753–755
  - AbstractButton, 937
  - Account, 162–166, 173–177, 183, 191, 244–246
  - ActionEvent, 858, 937
  - ActionListener, 802, 938
  - AddressBook, 609, 628, 667
  - AgeComparator, 673
  - AgeInputException, 469–470
  - ArrayList, 427, 597–598, 604, 759
  - Arrays, 672–674, 677–678
  - AssertionError, 472
  - AWT, 788–789
  - AWT button, 788–790
  - BankAccount, 472, 474
  - Bicycle, 152–162, 197–198, 389–390
  - BicycleRegistration, 154, 160–162
  - BookTracker, 419–423, 427–429, 604
  - BorderFactory, 815, 938
  - ButtonHandler, 803, 805
  - Calendar, 120–123
  - CDManager, 759
  - changing to a main class, 197–198
  - Character, 549
  - Client, 745–746
  - Color, 260–261
  - ComputeGrades, 774
  - Container, 798
  - CurrencyConverter, 631
  - Date, 342, 435, 681, 939
  - dealing with unknown, 273
  - DecimalFormat, 86, 104, 213, 335–336, 423, 939
  - defined, 17, 23, 46, 52, 151–220, 373–444
  - defined with inheritance, 737–741
  - Die, 186–188, 195–196
  - Dimension, 263–266
  - Door, 477, 480
  - Dorm, 477–480, 482, 485, 714–716
  - DrawableShape, 272, 274, 277–280, 283–288, 290–293
  - DrawingBoard, 259, 272–277, 281–282
  - DrawShape, 274, 276–277, 284, 288–293
  - Element, 178–185
  - Error, 451
  - Exception, 451, 454, 469, 471
  - ExpandableArray, 597
  - Faculty, 270–271
  - File, 940
  - FileManager, 533–534, 538–540
  - Format, 50, 768

- Formatter, 335–339, 940–941
- Fraction, 249–250, 374, 378, 386–387, 393, 402–405, 408–418, 439, 441, 460
- GraduateStudent, 738–743, 752–761, 770–774
- graphical representations of, 17
- GraphicLotteryCard, 265–266
- Graphics, 941–942
- GregorianCalendar, 83, 86, 120–124, 435, 942–943
- grouped into packages, 43–44
- HashMap, 605, 714, 759
- Heap, 646–647, 658–659, 682
- heavyweight, 789
- helper, 597
- HiLo, 352–355, 360–361, 366
- IllegalArgumentException, 460, 463, 611
- InputHandler, 482, 486–487, 493
- InputMismatchException, 447, 451, 460
- InputStream, 63
- instances of, 17
- instantiable, 198–205, 198–213, 621, 754
- IOException, 538
- Java standard, 32, 52–68
- java.awt.Color, 260–263, 276
- java.awt.Dimension, 263–266
- java.awt.Graphics, 257–260
- java.awt.Point, 263
- JavaFilter, 693–694
- JButton, 788–790, 804, 820, 839
- JCheckBox, 839–844
- JComboBox, 847–850, 876
- JComponent, 943–944
- JDialog, 790
- JFileChooser, 695, 729
- JFrame, 32, 44–47, 761, 793–796, 798–799, 807, 861–862, 944–945
- JLabel, 38, 214, 809, 813, 946
- JList, 850–853, 946–947
- JOptionPane, 86, 213, 689, 790, 947–948
- JPanel, 798
- JRadioButton, 844–847
- JSlider, 853–856, 948–949
- JTextArea, 809
- JTextComponent, 949–950
- JTextField, 809–810
- key concepts, 214, 437
- LibraryBook, 419–427, 429, 434–435
- LibraryCard, 169
- lightweight, 789
- LinkedList, 597–598
- listed alphabetically, 933–934
- listed logically, 934–935
- Loan, 199, 202–210, 341
- LoanCalculator, 199–210
- LotteryCard, 188–190, 265
- main, 47, 197–198
- MainWindow, 761
- Matcher, 517–521, 535, 544
- MatchJavaIdentifier, 513, 518
- Math, 86, 113–117, 126, 146, 295, 351, 360, 364, 391–392, 754, 950
- MealCard, 443
- MobileRobot, 180–181
- Monogram, 70, 86
- MouseEvent, 862, 866
- multiple, 162–166
- MyMenuFrame, 874
- myutil.Fraction, 408–418
- NameComparator, 673
- NoSuchElementException, 773
- Object, 749
- online documentation for, 52
- organizing into a package, 402–403
- OutputBox, 766, 872, 876
- OverdueChecker, 420–421, 429–434
- Pattern, 514, 517–521, 535, 544
- Person, 567, 578, 662–663, 665–666, 673
- Point, 263
- predefined, 52, 272–273
- PrintWriter, 707
- program, 70, 274, 352, 761
- programmer-defined, 32, 153, 172, 402–411
- Random, 86
- Resident, 477–479, 482
- Scanner, 63–64, 71, 107–112, 309, 351, 420–421, 529, 705–706, 792, 950–951
- Sibling, 742
- SimpleDateFormat, 60–63, 122, 335–336, 423, 951–952
- skeleton, 203
- SketchPad, 865–869
- standard, 32, 52–68, 152

Classes—*Cont.*

- String, 55–60, 70, 241, 248, 338, 420, 499–502, 510, 517, 523, 952–953
- StringBuffer, 524–528, 532, 549, 953–954
- StringBuilder, 524
- StringProcessing, 59
- StringTokenizer, 535
- Student, 738–743, 752–761, 770–773
  - summary of selected, 936–954
  - swing, 788–790
  - system, 32, 816
- TeachArithmeticFrame, 875–880
- Tester, 395
- TestRandom, 360–361
- TextHandler, 810
- Thesaurus, 629
- Throwable, 451–452, 454, 466–467
- TicTacToeCell, 835–837
- TicTacToePanel, 831, 835–839
- TreeMap, 605–608
- UndergraduateStudent, 738–743, 752–761, 770–774
  - unrelated, 737–738
  - using effectively with polymorphism, 741–744
- Vector, 598
- WordConcordance, 535–537, 541–545
- WordList, 543, 546, 608
  - wrapper, 603
- ClassNotFoundException, 712
- Client class, 745–746
- Client programs/programmers, 180, 182
- Clock, creating, 300–302, 369
- Clock speeds, 8–9
- COBOL (programming language), 11
- Code assembly, 11
  - blocks of, 43
  - by composition, 759
  - high-level, 11
  - modifying, 743
  - output from, 215–216
  - readable, 325
  - reviewing, 456
  - writing readable, 128, 234–235
- Coding phase, 25
- Collaboration diagrams, 958–959
- Color class, 260–263
- Color objects, 260–261
- Columns, aligning, 560
- Command Prompt window, 31
- Command prompt windows, opening, 905–906
- Comments, 39–43, 78
  - header, 42
  - javadoc, 41–42, 405–408, 444
  - markers for, 40
  - single-line, 40
  - uses of, 42–43
- Commercial programs, 41
- Communication devices, 4, 10
- Compact disks (CDs), 9–10
- Comparator interface, 672, 677
- compare method, 672
- compareAttribute method, 663
- compareTo method, 507, 663–665, 672
- Comparing objects, 247–252, 507
- Comparisons, 643
  - pairwise, 643
  - symbol for (==), 507
- Compilation errors, 751
- Compile-time errors, 600
- Compilers, 12, 50–51
  - adding default constructors, 750–752
- Compiling Java programs, 907
- Complex arithmetic expressions, 96
- Component diagrams, 961
- Components, program, 39–49
- Composition, code reuse by, 759
- Compound statements, 226
  - syntax for, 226
- Compute loan amount, 210–212
  - code, 132–133
  - design, 131–134
  - test, 133
- compute method, 166–172
- Compute monograms, 73–76
- computeCharge method, 420, 427, 435–444
- computeCourseGrade method, 740, 742–743
- ComputeGrades class, 774
- computePayment method, 200–202, 210–212
- Computer architecture, 4–10
  - simplified view of, 4–5
- Computer chips, 3

- Computer manuals, 9–10
  - Computer programming. *See* Programming
  - ComputerGrades program, 759–779, 782
  - Computers, 1–14
    - generations of, 3
    - history of, 2–4, 496
    - key concepts, 13
    - networked, 3–4
    - online slide show on, 4
    - personal, 3, 8
    - pioneers of, 2–4
  - Computing course grades program, 759–779
  - concatenation method, 102–103. *See also* String concatenation
  - Console I/O, 63, 444
  - Console user interface, 788
  - Console window, 53
  - Constants, 22, 99–101
    - double literal, 100
    - length, 561
    - literal, 100–101, 253
    - named, 100, 253
    - symbolic, 100
  - Constraints, on heaps, 647, 659
  - construct method, 654, 656
  - Construction phase, of heapsort, 648, 659
  - Constructors, 173–186
    - calling another constructor, 390
    - completing, 440–449
    - copy, 389
    - default, 176–183, 463, 750–752
    - defined, 177, 610, 749–752
    - explicit calls to, 752
    - inheritance and, 749–752
    - invalid, 611
    - multiple, 175, 389
    - overloaded, 175, 386–391, 440
    - and setFile, 717–719
  - Container class, 798
  - Content pane, 257–258, 797–798
  - contentPane objects, 831
  - continue (reserved word), 322
  - Control characters, 66
    - varying by platform, 543
  - Control flow, 222
    - one-entry one-exit, 325
  - Control-flow invariants, 474–475
  - Control statements, 222. *See also* Repetition control
  - Control string, formatting, 336–338
  - Control values, 336
  - Control variables, 327–328
    - declaring, 328
  - Controllers, 199
  - controlPanel objects, 831
  - Conventions, for naming, standard, 34, 46, 76, 78–79
  - Copy constructors, 389
  - Core 2 Extreme, 9
  - Count-controlled loops, 305
  - Course grades, program for computing, 759–779, 782
  - CPU. *See* Central processing unit
  - create method, 706
  - createBook method, 430
  - createStudent method, 771–773
  - Creating Java programs, 904
  - Cryptography, public-key, 553
  - Curly braces. *See* Braces ( { } )
  - CurrencyConverter class, 631
  - Current directory, 686–687
  - Cycles, 8
- D**
- Dangling else problem, 226, 237–238
  - Data buffers, 6
  - Data caching, 696
  - Data members, 21
  - Data types, 100–101, 254
    - arithmetic expressions of, 254
    - numerical, 85–150
    - primitive vs. reference, 92
  - Data values
    - arrays of, 557
    - graphical representations for, 22
    - saving, 702–703
  - DataInputStream objects, 704
  - DataOutputStream objects, 700–702
  - Date class, 60–63, 120, 342, 681, 939
  - Date objects, 82–83, 122, 342, 435
  - Deallocation, 37
    - of memory, 577

- Debugging, 25
- Decimal number system, 5–6
- Decimal-to-binary conversion, 6–7
- DecimalFormat class, 86, 104, 213, 335–336, 423, 939
- DecimalFormat objects, 104, 134, 184
- Declaration of Independence, online story about, 124
- Declarations, 46–47
  - invalid, 93
- Decrement operators, 235
- Decryption, 553
- deduct method, 162, 164–165, 195
  - tests within, 238
- default (reserved word), 253
- default case, 288
- Default constructors, 176–177, 463
  - added by compiler, 750–752
- Default delimiter, 108
- Defensive programming, 256
- Delegation-based event model, 802
- delete method, 621–625
- Deletion operation, for arrays, 575–576
- Delimiters (delimiter characters), 772
  - resetting, 65
- DeMorgan’s law, 241
  - truth table illustrating, 241
- Denominator, 409–410
- Dependency relationships, 32
- Deployment diagrams, 961–962
- Depth, of a heap, 658–659
- Derived class, 23, 735
- Descendants, 23
- describeProgram method, 200–202, 212–215, 341
- describeRules method, 353, 361
- Design alternatives, 71–72, 613
- Design phase, 25
- Destinations, of outputs, 695
- Development
  - bottom-up, 200
  - incremental, 86, 275
  - software, 15–28
  - steps in, 71, 126–128, 200, 275, 352, 421, 535, 610, 717, 763
  - top-down, 199
- Diagrams, program, 41
- Die class, 186–188, 195–196
- Difference Engine, 2
- Digital video cameras, 8
- Dimension objects, 278
- dimension variable, 283
- Directories, current, 686–687
- Directory listing, of algorithms, 883–885
- directoryListing method, 883–885
- Disk drives, 8–9
- Display monograms, 73–76
- displayOutput method, 209–210
- Divide-by-zero error, 242
- Division operators, 94
- DNA sequences, 529–532, 629
- DNA transcription, 531
- do-while loops, 326, 353
- do-while statements, 319–323
  - controlling flow of, 320
  - correspondence to general format, 320
  - syntax for, 319
  - writing, 363
- Documentation, program, 41
- Door class, 477, 480
- Door objects, 480–481
- Dorm class, 477–480, 482, 485, 714–716
- Dorm objects, 477, 479, 488, 714
- Dot notation, 44, 193, 195, 385, 392
- Double ampersand (&&), 239, 242, 511
- double data type, 87–93, 94, 97, 100–101, 165
  - arrays of, 557–559, 583, 627
- double literal constants, 100
- Double minus operator (—), 235
- Double plus operator (++), 235
- Double slashes (//), 40
- double values, 100–101, 167
- Double vertical bar (||), 239, 242
- draw method, 260–261, 281, 283
- DrawableShape class, 272, 274, 277–280, 283–288, 290–293
- DrawableShape objects, 276
- Drawing graphics, 256–266
  - java.awt.Color, 260–263
  - java.awt.Dimension, 263–266
  - java.awt.Graphics, 257–260
  - java.awt.Point, 263
- drawing methods, defined for Graphics class, 259–260

- Drawing shapes program, 272–293
  - DrawingBoard class, 259, 272–277, 281–282
  - DrawingBoard objects, 276–277, 279
  - DrawingBoard window, 277
  - drawLine method, 836
  - drawOval method, 836
  - drawRect method, 258
  - DrawShape class, 274, 276–277, 284, 288–293
  - drawShape method, 283
  - Drive-through ordering system, 302
  - Drop-down lists, 848
  - Duplicate code, avoiding, 196
  - Duplicate tests, eliminating, 322
- E**
- Echo printing, 64, 72, 128
  - Eckert, J. Presper, 3
  - Edit-compile-run cycle, 49–52
  - Eggy-Peggy (word game) program, 550, 552
  - Element class, 178–185
  - Elements. *See also* Array elements
  - else (reserved word), 227
  - Else blocks, 224–228
    - rules for writing, 228
  - Empty strings, 548
  - Encapsulation mechanism, 180–181
  - Encryption, 553
  - End cases, 348, 623
  - end method, 520
  - endIdx, 507, 509
  - Engineering, software, 24–26
  - Enhanced editor approach, 908–909
  - Enhanced for loop, 577
  - ENIAC I (Electronic Numerical Integrator And Calculator), 3
  - enlarge method, 614
  - EntranceMonitor program, 481–482
  - entry array, 668
  - entrySet method, 606
  - enum (reserved word), 267
  - Enumerated constants, 266–271
  - Environment, setting for Java programs, 906–907
  - Equal symbol (==), 251
  - Equality testing, 248, 507, 521–522
  - equals method, 248–250, 507, 521–522
  - equalsIgnoreCase method, 248, 507
  - Equivalence test, 521–522
  - Error class, 451
  - Error messages, 50–51, 255, 320
  - Errors. *See also* Exceptions
    - common in programming, 246
    - compilation, 51, 101
    - divide-by-zero, 242
    - execution, 52
    - identifying, 77–78
    - off-by-one, 315–316
    - overflow, 314
  - Escape character, 66, 687
  - Estimation, of execution time, 342–346
  - Euclidean algorithm, 311, 345
  - Event-driven programming, GUI objects and, 787–880
    - key concepts, 871
  - Event listener objects, 802, 806–808
  - Event model, delegation-based, 802
  - Event sources, 802
  - Events
    - action, 802
    - handling, 802
  - Exception catcher methods, 458–460
  - Exception class, 451, 454, 469, 471
  - Exception propagator methods, 458–460
  - Exception-throwing methods, 458, 510–511
  - Exceptions, 445–494
    - catching, 446–453
    - checked, 466
    - defined, 446
    - differentiating from assertions, 475–476
    - key concepts, 492
    - out-of-bound, 505
    - programmer-defined, 469–471
    - propagating, 458–466
    - runtime, 466
    - thrown, 453–458
    - unchecked, 466
  - Excess format, 139
  - Exchange rate, computing, 631
  - Exclamation point (!), 239
  - Execution errors, 52
  - Execution time, estimating, 342–346
  - expand method, 616



- ExpandableArray class, 597
  - Explicit calls, to constructor of superclasses, 752
  - Explicit casting conversions, 96–97
  - Exponential notation, 101
  - Exponents, computing, 296
  - Expressions
    - arithmetic, 94–99
    - Boolean, 239–247
    - indexed, 558
    - invalid, 141
    - regular, 510–517
  - extends (reserved word), 735, 739, 795
  - extends clause, 749
  - Extensions, possible, 293
  - extract method, 655–657
  - Extraction phase, of heapsort, 648, 658
- F**
- Factorials, computing, 347–349, 882–883
  - Faculty class, 270–271
  - false (logical value), 93
  - false (reserved word), 38
  - Fermi (game), 443–444, 879
  - Fibonacci numbers, 145, 367, 895–896
  - Fields, 335
  - File access, 686
  - File class, 940
  - File filters, 693
  - File I/O, 685–732
    - high-level, 700–709
    - low-level, 695–699
  - File objects, 686–695, 761, 883–885
  - FileInputStream objects, 697–699, 704, 711
  - FileManager class, 533–534, 538–540
  - FileManager objects, 540, 707
  - FileNotFoundException, 539, 706–707
  - FileOutputStream objects, 695–697, 702–703
  - FileReader objects, 704, 761
  - Files
    - closing, 696
    - opening, 688
  - fill method, 260–261
  - finally (reserved word), 456
  - finally blocks, 456–457
  - find method, 519
  - findIndex method, 621–622
  - First generation computers, 3
  - Fixed-pitch fonts, 809
  - Fixed-size array declarations, 565
  - Flags, 243
    - boolean, 243
    - longMessageFormat, 243
  - float data type, 87–93, 94, 97, 100–101
  - Floating-point format, 136, 138
  - Floppy disks, 8–9
  - FlowLayout, 800, 820–821
  - Fonts, 809
  - for-each loops, 330, 577–582, 600
    - nesting, 596
  - for loops, 330, 561–563, 577–578, 766, 884, 886–887
  - for statements, 327–331. *See also* Nested-for statements
    - controlling flow of, 327
    - correspondence to general format, 327
    - inner, 333
    - outer, 333
  - Force between two bodies, computing, 145–146
  - Formal parameters, 167
  - Format class, 768, 770
  - format method, 338. *See also* javabook.Format
  - Formats. *See* ASCII; Binary number system
  - Formatter class, 335–339, 940–941
  - FORTRAN (programming language), 11
  - Forward slash (/), 687
  - Fourth generation computers, 3
  - Fraction class, 249–250, 374, 378, 386–387, 393, 402–405, 439, 441, 460
    - complete, 408–418
  - Fraction objects, 375–376, 378, 380–381, 383–384, 389, 392
  - Fractions
    - normalized, 139
    - unnormalized, 139
  - Frame windows, customizing, 790, 793–799
  - Frames
    - content pane of, 257–258
    - making the event listener, 806–808
  - French, 498
  - friends list, 600–602

Fully qualified names, 44  
 Functions. *See* Math classes

## G

gamePanel objects, 831  
 Games. *See* Eggy-Peggy; Fermi; HiLo (game)  
     program; playGame method  
 Garbage collection, 37, 577  
 gcd. *See* Greatest common divisor  
 General-purpose frames, 790  
 generateLoanTable method, 341  
 generateSecretNumber method, 353–360  
 Geometric functions. *See* Math classes  
 German, 498  
 get methods, 158, 435, 600, 606, 629  
 getAbsolutePath method, 691, 884  
 getActionCommand method, 804, 858  
 getAge method, 449, 451, 460–462, 469–470  
 getBookList method, 420  
 getBounds method, 866  
 getCenterPoint method, 278  
 getCharge method, 427  
 getComparator method, 674  
 getConcordance method, 543  
 getContentPane method, 797–798  
 getDimension method, 278  
 getFirstPerson method, 724  
 getInitialBalance method, 162, 164  
 getInput method, 200–202, 204, 487, 493  
 getKey method, 606  
 getList method, 427, 443  
 getLoanAmount method, 341  
 getLoanPeriod method, 205  
 getMaximumSpeed method, 19–20  
 getMessage method, 452  
 getMonthlyPayment method, 209–211  
 getName method, 487  
 getNextGuess method, 356–359  
 getNextPerson method, 724  
 getObstacleDistance method, 19  
 getOwnerName, 157–152  
 getOwnerName method, 156, 159, 170  
 getPeriod method, 205  
 getProperty method, 816  
 getRootPane method, 804  
 getSelectedIndices method, 848, 851

getSelectedItem method, 848  
 getSelectedValues method, 851  
 getShape method, 289  
 getSource method, 804  
 getTime method, 122, 342, 435  
 getTotalPayment method, 209–211  
 getValue method, 606  
 Gigahertz (GHz), 8  
 Google search engine, 533  
 Gosling, James, 12  
 GraduateStudent class, 738–743, 752–761,  
     770–774  
 Granularity, 346  
 Graphical representations, for data values, 22  
 Graphical user interface. *See* GUI objects  
 GraphicLotteryCard class, 265–266  
 Graphics, drawing, 256–266  
 Graphics class, 259–260, 941–942  
     drawing methods defined for, 259–260  
 Graphics context, drawing a text in, 293  
 Graphics objects, 257  
 Gravitational constant, computing, 145–146,  
     328–330, 370–379  
 Greatest common divisor (gcd)  
     computing, 899  
     finding, 310–313  
     methods, 342–343, 375–376, 392  
 Gregorian calendar system, 124  
 GregorianCalendar class, 83, 86, 120–124, 435,  
     942–943  
 GregorianCalendar objects, 120, 122–124, 145, 272,  
     430, 434  
 GridLayout objects, 825–826  
 GUI (graphical user interface) objects, 787–880  
     components of, 839–856  
     key concepts, 871  
 GUI programming, basics, 799–808

## H

Hard disks, 8–9  
 HashMap class, 605, 714, 759  
 hasNext method, 600  
 Header comments, 42  
 Heap class, 646–647, 658–659, 682  
     constraints on, 647, 659  
     depth of, 658–659

- Heap class—*Cont.*
    - modifying, 682
    - root of, 646
  - Heap structure, 648, 651
  - Heaps, 646
  - Heapsort, 646–659
    - performance of, 657–659
    - rebuild step, 648–650
  - Heapsort algorithm, 648, 651
  - Heavyweight classes, 789
  - Helper classes, 604
  - Hertz, 8
  - Heterogeneous lists, 599
  - Hiding information, 180
  - Hierarchies, of inheritance, 24
  - High-level code, 11
  - High-level files, 700–709
  - High-level programming languages, 11–12, 14
  - HiLo class, 352–355, 360–361, 366
  - HiLo (game) program, 351–361
  - HiLoDisplay, 833
  - Homogeneous lists, 599
  - Human Genome Project, 529
- I**
- I/O. *See* Input/output devices
  - IBM, 3
  - IDE. *See* Integrated development environment
  - Identifiers, 33
    - invalid, 38–39, 78–79
  - IEEE (Institute of Electronics and Electrical Engineers) Standard, 138
  - if statements, 222–232, 296. *See also* Nested-if statements
    - controlling flow of, 224, 228–229
    - formatting styles for, 226–228
    - invalid, 232
    - rewriting, 296
    - syntax for, 231, 233
  - if tests, 234
  - if-then-else statements, 246, 779
    - syntax for, 223
  - if-then statements, syntax for, 223, 228
  - IllegalArgumentException class, 460, 463, 611
  - ImageIcon objects, 813
  - Implementation classes, enforcing consistency
    - among, 660
  - implements Serializable (phrase), 479, 710, 716
  - Implicit casting conversions, 96–97
  - Import statements, 43–46, 78
  - Imprecise loop counters, 314
  - Increment operators, 235
  - Incremental development, 69, 86, 275
  - Indentation, 235–237
    - styles of, 236–237
  - IndependenceDay program, 123, 124
  - Indexed expressions, 558
  - indexOf method, 58, 73–74
  - IndexOutOfBoundsException error, 600
  - Infinite loops, 313–318
  - Information hiding, 180
  - Inheritance, 23–24
    - and constructors, 749–752
    - defined classes with, 737–741
    - guidelines for using, 749–752, 758–759
    - hierarchies of, 24
    - and member accessibility, 744–749
    - and polymorphism, 733–785
  - Initialization, 88–93
    - of class variables, 663
  - Initials, program for printing, 69–75
  - Input buffers, 108
  - Input files, 685–732
  - Input/output (I/O) devices, 4–5, 8. *See also* File I/O; Object I/O
  - Input values
    - accepting, 127–129, 204–208
    - code, 206–208
    - getting numerical, 107–112
  - inputBooks method, 429
  - inputColor method, 288–289
  - inputFile method, 540
  - InputHandler class, 482, 486–487, 493
  - InputHandler object, 488, 490
  - inputLine text field, 812
  - InputMismatchException class, 447, 451, 460
  - Inputs, 86
    - sources of, 697
  - inputShapeType method, 288, 307
  - InputStream class, 63
  - Insertion sort, 680–681

- Installing Java programs, 903–904
  - Instance constants, 23
  - Instance data values, 20–23
  - Instance methods, 18, 393, 405
    - declaring private, 182
  - Instance variables, 23, 615
    - declaring private, 182
  - instanceof operator, 810
  - Instances, of classes, 17
  - Instantiable classes, 621, 754
    - loan calculator program with, 198–213
  - Institute of Electronics and Electrical Engineers.
    - See* IEEE
  - int data type, 87–93, 97, 252, 254
  - Integer division, 94
  - Integer division operators, 94
  - Integer indices, 605
  - Integer objects, 603
  - Integer.parseInt method, 430
  - Integers, 86–92
    - computing the greatest common divisor, 899
    - data types for, 87–93
    - initializing, 88–93
    - representation of, 136
    - sorting, 638–639, 680
  - Integrated circuits, 3
    - large-scale, 3
  - Integrated development environment (IDE), 903, 909
  - Integration testing, 25
  - Intel processors, 8–9
  - Interest rates, computing, 147
  - Interface objects. *See* GUI objects
  - Interfaces
    - guidelines for using, 598, 758–759
    - implementation of, 660
    - listed alphabetically, 933–934
    - listed logically, 934–935
    - summary of selected, 936–954
    - user-friendly, 319
  - Internet, 4
    - Java language for, 498
  - Interpreters, 51
  - intList, 603
  - intValue method, 603
  - IOException class, 538–539
  - IOException objects, 706–707, 712, 719
  - IS-A relationship, 758
  - isFile method, 688
  - isMetaDown method, 866
  - isMoving method, 244
  - isRadiusValid method, 231
  - isSelected method, 840
  - isSorted method, 641
  - isUpperCase method, 549
  - isValidHeap method, 655
  - itemStateChanged method, 842, 847
  - Iteration, 600
  - iterator method, 600
- ## J
- Japanese, 498
  - Java 2 SDK (*Software Development Kit*), versions, 473, 524, 603, 705, 709, 797, 903–904
  - Java API reference manuals, 52, 62, 256, 606, 629, 773
  - Java applets. *See* Applets
  - Java applications, 12, 30–52, 78
  - Java classes, standard, 32, 52–68
  - Java Collection Framework (JCF), 597, 600, 606, 608, 610, 629
  - Java compilers, 236–237
  - Java interpreters, 51
  - Java language, 498. *See also* Math classes; Programs
    - coding standards, 227
    - development tools, 49–52
    - exponential notation in, 101
    - introduction to, 12
    - key concepts, 76
    - programming basics, 29–80
    - translating pseudocode into, 340–342
  - Java Language Specification, 227
  - Java naming conventions, 34, 46, 76, 78–79
  - Java Native Interface (JNI), 477
  - Java packages. *See also* javabook package
    - java.awt, 256–266, 788
    - java.awt.Color class, 260–263, 276
    - java.awt.Dimension class, 263–266
    - java.awt.Graphics class, 257–260
    - java.awt.Point class, 263
    - java.sql, 83

Java packages—*Cont.*

- java.text, 61
- java.util, 60, 83, 120, 597, 672, 677, 682, 772
- java.util.regex, 517
- javax.swing, 44–45, 689, 693, 771, 790, 800, 816

Java programs. *See also* Sample programs

- compiling the program, 907
- creating a program, 904
- how to run, 903–910
- installing, 903–904
- opening a command prompt window, 905–906
- running the program, 907
- saving the program, 904–905
- setting the environment, 906–907

Java standard classes, 32, 52–68

Java stream objects. *See* Stream objects

Java Virtual Machines (JVM), 52

javabook package, 45–46, 768

- importing, 45–46

javabook.Format, 306

javadoc comments, 41–42, 444

- using for class documentation, 405–408

javadoc files, 407

javadoc tags, 404

JavaFilter class, 693–694

JavaPrograms directory, 686

JavaPrograms folder, 402–403

JButton class, 788–790, 804, 820, 839

JCF. *See* Java Collection Framework

JCheckBox class, 839–844

JCheckBox objects, 842

JComboBox class, 847–850, 876

JComboBox objects, 850

JComponent class, 943–944

JDialog class, 790

JDialog objects, 547

JFileChooser class, 695, 729

JFileChooser objects, 686–695, 771

- displaying, 689, 691

JFrame class, 32, 44–47, 761, 793–796, 798, 944–945

- creating subclasses of, 799, 807, 861–862

JFrame objects, 32

JLabel class, 809, 813, 946

JLabel objects, 812

JList class, 850–853, 946–947

JMenu objects, 857–858

JMenuBar objects, 857

JMenuFrame window, 857

JMenuItem objects, 857

JNI. *See* Java Native Interface

JOptionPane class, 86, 213, 689, 790, 947–948

JPanel class, 798

- subclasses of, 835

JPanel objects, 829–830

JRadioButton class, 844–847

JScrollPane class, 819, 851, 872

- adding scroll bars automatically, 819

JSlider class, 853–856, 948–949

JSlider objects, 853

JTextArea class, 809

JTextArea objects, 809, 814–815, 873

JTextComponent class, 949–950

JTextField class, 809–810

JTextField objects, 809

JVM. *See* Java Virtual Machines

**K**

Kanji characters, 498

Key-value pairs, 606

Keyboards, 5, 8

Keyless entry system program, 477–491

Korean, 498

**L**

Languages. *See* Programming languages

LANs. *See* Local area networks

Layout managers, 820–829

- and panels, 800

Leap Year, computing, 297

Length constants, of an array, 561, 591

length method, of String objects, 58, 561

Level, of nodes, 658

Library Overdue Checker program, 418–436

LibraryBook class, 419–427, 429, 434–435

LibraryBook objects, 425

LibraryCard class, 169

LibraryCard objects, 169, 171–172

Life cycle, of software, 24–26

Lightweight classes, 789

Line separator, 816

Linear searching, 634–635

- Linked-node representation, 597
  - LinkedList class, 597–598
  - List interface, 597–598, 606
  - Listeners, multiple, 803
  - Lists, 596–605
  - Literal constants, 100–101, 253
  - Loan amount, computing, 131–129, 210–212
  - Loan class, 199, 202–210, 341–342
  - Loan objects, 204–205
  - Loan tables, 339–342
  - LoanCalculator class, 199–210
    - skeleton for, 203
  - LoanCalculator program, 125–136, 340–342, 367–371
    - with an instantiable class, 198–213
  - Local area networks (LANs), 4, 10
  - Local variables, 191–193
  - Logical operators, 239
  - long data type, 87–93, 97
  - longMessageFormat flag, 243
  - Loop-and-a-half repetition control, 323–326
    - checklist for, 325
  - Loop body, 304
  - Loop counters, imprecise, 314
  - Loop statements, 304
    - infinite, 313–318
    - nested, 341–342
    - posttest, 319
    - pretest, 319
    - terminating, 322, 505, 767
  - Loops
    - improving user interface with, 306–308
    - programming with, 309–310
  - LotteryCard class, 188–190, 265
  - Lovelace, Ada, 2
  - Low-level file I/O, 695–699
- M**
- Mac platform, 687
  - Machine code, 11
  - Machine languages, 11
  - Magnetic strip readers, 8
  - Main classes, 47
    - changing any class to, 197–198
  - main method, 32, 198
  - Maintenance, 25
  - MainWindow class, 761
  - Map interface, 606–607, 677
  - Maps, 605–608
  - MARK I, 3
  - Markers
    - \*/, 40, 404
    - /\*, 40
    - /\*\*, 404
    - //, 40
    - for comments, 40
    - matching, 41
  - Matcher class, 517–521, 535, 544
  - Matcher objects, 518, 545
  - matches method, 510–515, 517–518
  - Matching, pattern, 510–517
  - Matching cases, 254–256
  - MatchJavaIdentifier class, 513, 518
  - Math classes, 86, 113–117, 126, 146, 295, 351, 360, 364, 391–392, 754, 950
    - methods for common mathematical functions, 113–114
  - Mauchly, John W., 3
  - maxBottom method, 645
  - maxChild method, 656
  - MealCard class, 443
  - Megahertz (MHz), 8
  - Member accessibility, inheritance and, 744–749
  - Memory
    - allocation of, 89, 397, 558, 581
    - nonvolatile, 8
    - volatile, 8
  - Memory locations, 11
  - Memory usage, 91
    - varying with precision, 88
  - Menus, 857–861
  - Merge sort, 677, 900
  - Messages, 18–20
    - errors in, 52
    - printing, 296
    - sending, 18–20, 33, 37–39
    - syntax for, 37
  - Method body, 47, 754
  - Method composition, 56
  - Method declarations, 47–48
    - syntax for, 47
  - method names, 47

- Method prototype, 597
  - Method signature, 388
  - Methods, 18–20
    - abstract, 754
    - calling, 37–38, 201–202
    - overloaded, 386–391, 440–441
    - passing arrays to, 582–588
    - passing objects to, 168–173
    - recursive, 346–350
    - returning an object from, 374–378
    - reverse, 532
    - of the same class, calling, 193–197
    - shortening, 779
    - value-returning, 157
    - void, 156
  - Metric conversion, 86
  - Microcomputers, 3
  - MIDI devices, 8
  - min methods, 392, 641–642
  - Minicomputers, 3
  - Minimalist approach, to running Java
    - programs, 12
  - Minus (–) symbol, 182. *See also* Subtraction operators
  - MobileRobot class, 180–181
  - Modems, 10
  - modifiers, 47–48
    - accessibility, 156
    - protected, 739, 744–749
    - visibility, 180–181, 741
  - Modulator-demodulator, 10
  - Modulo arithmetic, 311
    - division, 94
  - Monitors, 5, 8
  - Monogram class, 70
    - program diagram for, 70, 86
  - Month objects, 627
  - Mortgages, computing. *See* LoanCalculator program
  - Motion type, selecting, 291–293
  - motionStatus, 244
  - Motorola PowerPC, 11
  - Mouse, 5, 8
    - movement of, 86
  - Mouse events, handling, 861–869
  - mouseClicked method, 865–867
  - mouseDragged method, 865–867
  - MouseEvent class, 862, 866
  - MouseEventListener interface, 865
  - Multimedia information, viewing, 4
  - Multiple classes, defined and using, 162–166
  - Multiple constructors, 175, 389
  - Multiple listeners, 803
  - Multiple methods, 388
  - Multiple shapes, drawing, 293
  - Multiple stop conditions, 322
  - Multiplication operators, 96
  - Musical instrument digital interface. *See* MIDI devices
  - MusicCD objects, 384
  - Mutator methods, 158
  - My Documents folder, 689
  - My First Subclass, 795
  - MyFirst program, 30–39, 904–907
  - MyMenuFrame class, 874
  - myutil package, 402–403, 442–451
  - myutil.Fraction class, 408–418
  - MyWindow objects, 32–35, 38
- ## N
- NameComparator class, 673
  - Named constants, 100, 253
  - Names, displaying in reverse, 67
  - Naming
    - fully qualified, 44
    - standard conventions for, 34, 46, 76, 78–79
  - National Institutes of Health, 529
  - NCAA championship, 115
  - Nested-for statements, 332–334
    - rewriting as nested do-while statements, 364
    - rewriting as nested while statements, 364
  - Nested-if statements, 233–239
    - controlling flow of, 233
  - Nested loop statements, 341–342, 363
  - Nested panels, effective use of, 830–839
  - Nestings
    - minimizing, 236
    - showing structure clearly, 235–237
  - Network interface cards (NICs), 10
  - Networks, 4
  - Neumann, John von, 3
  - new-line control character, 105
  - new method, 500

- new operator, 35, 250–251, 522, 557
  - next method, 600, 706
  - nextDouble method, 109, 706
  - nextInt method, 107, 706
  - NICs. *See* Network interface cards
  - Nodes
    - left and right children of, 647
    - level of, 658
    - root, 646
  - Noninteger indices, 605
  - Nonvolatile memory, 8
  - Normal case, 623
  - Normalized fractions, 139
  - NoSuchElementException class, 773
  - NOT operators, 239–240
  - Notation. *See* Asterisk notation; Dot notation; Exponential notation; Scientific notation; Shorthand notation
  - null (reserved word), 170
  - Null references, 575–576, 621
  - Number systems, 6–7
  - NumberFormatException error, 793
  - Numbers. *See also* Standard deviation, computing
    - arrays of, 578
    - computing factorials of, 347–349
    - computing greatest common divisor of, 899
    - converting to Roman numerals, 298
    - Fibonacci, 145, 367
    - perfect, 366
    - random, 119–120
    - variables for, 90
  - Numerator, 409–410
  - Numeric promotion, 97
  - Numerical data declaration, 91
  - Numerical data types, 85–150
    - key concepts, 140
  - Numerical input values, getting, 107–112
  - Numerical representation, 136–139
  - Numerical values, displaying, 101–107
- O**
- Object class, 749
  - Object creation, 35–37
    - syntax for, 35
  - Object declaration, 33–34, 36, 91
    - syntax for, 33
  - Object diagrams, 127
    - notation for, 35–36
  - Object I/O, 709–716
  - Object names, 79. *See also* Identifiers; Naming
  - Object-oriented programming (OOP), 12, 15–28, 52
    - basic concepts of, 16, 27
    - power of, 342
  - Object-oriented software engineering (OOSE), 955
  - ObjectInputStream objects, 710–711
  - ObjectOutputStream objects, 709–710, 719
  - Objects, 16–18, 31
    - arrays of, 567–577
    - comparing, 247–252
    - defined, 16
    - erasing from memory, 576
    - graphical representations of, 16
    - passing to a method, 168–173
    - referenced, 743
    - returning from a method, 374–378
    - saving, 712
    - storing, 709–710
    - variables for, 90
  - Off-by-one errors (OBOEs), 315–316, 619
  - Oldest person, finding, 570
  - One-dimensional arrays, 589
  - One-entry one-exit control flow, 325
  - OOP. *See* Object-oriented programming
  - OOSE. *See* Object-oriented software engineering
  - openFile method, 538–540
  - Operands, 95
  - Operation phase, 25
  - Operator overloading, 103
  - Operators. *See also* Arithmetic operators; Boolean operators; Relational operators
    - AND, 239–240, 242
    - addition, 96
    - arithmetic, 94
    - assignment, 98–99
    - binary, 95, 97
    - Boolean, 239–240
    - decrement, 235
    - division, 94
    - increment, 235
    - integer division, 94
    - logical, 239
    - multiplication, 96



Operators—*Cont.*

- NOT, 239–240
- OR, 239–240, 242
- precedence rules for Boolean, 243
- string concatenation, 59
- type cast, 97
- OR operators, 239–240, 242
  - Java symbols for, 242
- Ordering system, drive-through, 302
- Out-of-bound exceptions, 505
- outDataStream, 701
- outFile objects, 701
- outFileStream, 701
- Output devices, 4–5, 8
- Output statements, 256. *See also* Temporary output statements
- Output values, 209–210
  - design, 129–131
  - test, 131
- OutputBox class, 766, 873, 876
- Outputs, 86, 215–216
  - file, 685–732
  - formatting, 334–339
  - making readable, 890
- outStream objects, 699
- OverdueChecker class, 420–421, 429–434
- OverdueChecker objects, 429
- Overflow, handling with enlarge method, 596
- Overflow errors, 314
- Overloaded constructors, 175, 386–391, 440
- Overloaded methods, 386–391, 440–441
- Overloading, operator, 103

**P**

- Package visibility, 748
- Packages. *See also* Java packages; javabook package
  - classes grouped into, 43–44
  - organizing classes into, 402–403
  - programmer-defined, 909–910
- Pairwise comparisons, 643
- Palindromes, finding, 550
- Panels. *See* Nested panels
- @param tag, 405
- Parameters, 47–48, 167
  - matching with arguments, 166–168
- Parentheses, 96, 97
- partition method, 891–895
- Pascal (programming language), 12
- Pass-by-value scheme, 395–397, 400
- Passes, sorting, 639
- Passing arrays, to methods, 582–588
- Pattern class, 514, 517–521, 535, 544
- Pattern matching, and regular expression, 510–517
- Pattern objects, 518, 545
- payScaleTable array, 589–596
- PDA, Pocket PC, 790
- PDF format documents, 497
- Pentium 4, 8, 11
  - Extreme Edition, 9
- Perfect numbers, 366
- Periodic table, 177–185
- Person class, 567, 578, 662–663, 665–666, 673. *See also* AddressBook program; AddressBook class
- Person objects, 568–569, 571, 576, 599–602
  - adding to an array, 613, 617
  - comparing, 659–679
  - creating, 569
  - reading, 724
  - removing, 621, 623
  - returning, 618
  - saving, 710
- Pixel (picture element), 30
- playGame method, 353–359
- Plus (+) symbol, 182. *See also* Addition operators
  - for concatenation of values, 102–103
  - for string concatenation, 59
- Pocket PC PDA, 790
- Pointers, self-referencing, 379
- Polymorphic messages, 734
- polymorphic method, 736
- Polymorphism
  - benefits of, 743
  - defined, 734, 741–742
  - inheritance and, 733–785
  - using classes effectively with, 741–744
- Population growth, computing, 146–147
- Position values, 5–6
- Positioning. *See* Absolute positioning
- Postcondition assertions, 474

- Posttest loop, 319
- pow method, 126
- Precedence rules, 95–96, 242–243
- Precision
  - higher, 87
  - of real numbers, 314
- Precondition assertions, 474
- Predefined classes, 52, 272–273
- Pretest loop, 319
- Prices, printing out table of, 332–334, 366–367
- Prime Number Theorem, 366
- Prime numbers, 366
- Priming read, 307
- Primitive data types, 92, 247–248, 521, 523, 527, 602–605
- print method, 54, 101, 703, 761
- Printers, 5, 8
- printf method, 338
- Printing, echo, 64, 72, 128
- Printing initials program, 69–75
- println method, fine-tuning, 131
- println method, 55, 66, 101–102, 703, 761
- printout, 724
- printResult method, 763, 766–769
- printStackTrace method, 452, 469
- PrintWriter classes, 707
- PrintWriter objects, 703
- Private class constants, 182
- private methods, 156, 353, 357
- private (reserved word) modifier, 156, 180–183, 673, 739, 745–748, 757
- Problem statements, 69, 273, 351, 419, 533, 609, 716, 760
- processData method, 762
- processInputData method, 490
- Program classes, 70, 274, 352, 761
- Program components, 39–49
- Program diagrams, 36, 41
- Program documentation, 41. *See also* Comments; Object diagrams; Programmers; User manuals
- Program implementation, 126
  - sequence for, 126
- Program readability, 71, 226–228
  - computing, 146
- Program review, 293, 625, 724, 779
- Program skeletons, 200–206, 275–277, 352–355, 482–486, 536–538, 763–766
  - with constructors, 610–612
  - designs for, 200
- Program tasks, 70, 125, 199, 273, 419, 534, 761
- Program templates, 48–49
- Program verification, 204
- Programmer-defined classes, 32, 153, 172, 402–411
- Programmer-defined exceptions, 469–471
- Programmer-defined packages, 909–910
- Programmers
  - client, 180
  - work logs of, 496
- Programming, 24. *See also* Event-driven programming; Object-oriented programming
  - computation, 86
  - defensive, 256
  - good style in, 128, 234–235
  - incremental development, 86
  - inputs, 86
  - object-oriented, 15–28
  - outputs, 86
  - tasks comprising, 86
- Programming languages, 1–14
  - classes of, 11–12
- Programs
  - AddressBook, 716–724
  - building word concordance, 533–546
  - calculator, 877
  - client, 180
  - commercial, 41
  - ComputeGrades, 759–779, 782
  - drawing shapes, 272–293
  - Eggy-Peggy (word game), 550, 552, 726
  - EntranceMonitor, 481–482
  - HiLo (game), 351–361
  - keyless entry system, 477–491
  - Library Overdue Checker, 418–436
  - LoanCalculator, 125–136, 198–213, 340–342, 367–371
  - MyFirstJava program, 30–39
  - printing initials, 69–75
  - RoomWinner, 264–266
  - sorting AddressBook, 659–679
  - terminating, 31

Project files, 50  
 Promotion, 97  
 Propagation, of exceptions, 458–466  
 protected (reserved word) modifier, 739, 744–749  
 Pseudocode representation, 340–342  
 Pseudorandom number generator, 118  
 Public class constants, 182, 190–191  
 Public-key cryptography, 553  
 public methods, 156  
 public (reserved word) modifier, 180–183, 267, 673, 739, 745–748  
 Punch cards, 2  
 Punctuation, 503. *See also* individual marks of punctuation  
 Pushbuttons, 799, 839, 845

## Q

Quadratic equations, solving, 144  
 Quicksort algorithms, 890–895

## R

Radio buttons, 839, 844–845  
 Radix, 6  
 Random access memory (RAM), 4, 7  
 Random class, 86  
 random method, 351, 359  
 Random motion type, 291  
 Random numbers, generating, 119–121  
 Rank types, 271  
 Read access, 686  
 read method, 697, 722–724  
 Read-only traversals, 602  
 readData method, 762–779  
 readDate method, 429  
 readDoubles method, 429, 583–597  
 readIntegers method, 585  
 readLine method, 704  
 readObject method, 711–712, 714  
 readString method, 429  
 Real numbers
 

- data types for, 87–93
- in loop counters, 314–315
- representation of, 137–138

 Rebuild steps, 648–650
 

- sequences of, 649

 Rectangle, bounding, 263

Recursion, 882–883
 

- basic elements of, 882–883
- defined, 346–347
- guidelines for using, 350, 895–897
- necessary components in, 348
- sequence of calls for, 349
- terminating, 348

 Recursive algorithms, 881–901  
 Recursive methods, 346–350  
 Reference data type, 92, 521  
 Referenced objects, 743  
 Registers, 8, 11  
 Regular expression
 

- defined, 511
- pattern matching and, 510–517

 Relational operators
 

- in boolean expressions, 223–224
- reversing, 239–240

 Relays, mechanical, 3  
 remove method, 601  
 Rentals
 

- computing charges for, 300
- tracking, 879–880

 Repetition control, 306
 

- checklist for, 320
- loop-and-a-half, 323–326

 Repetition statements, 222, 303–372
 

- defined, 304
- key concepts, 358
- pitfalls in writing, 313–318
- terminating, 505

 replaceAll method, 515–517, 523  
 Reserved words, 38, 78  
 reset method, 544  
 Resident class, 477–479, 482  
 Resident objects, 479, 494, 714  
 return (reserved word) statements, 158, 457
 

- syntax for, 158

 @return tag, 405  
 Return types, 47–48  
 reverse method, 532  
 Reversing relational operators, 239–240  
 RGB color scheme, 260–261, 853–854  
 RNA sequences, 531, 629  
 Robot objects, 19–20, 181

- roll method, 186–187
- Roman numerals, converting numbers to, 298
- RoomWinner program, 264–266
- Root node, 646
- Root pane, 804
- roster arrays, 742–743, 764, 766–767, 771, 779.
  - See also* buildRoster method
- RSA cryptography system, 553–554
- Running Java programs, 903–910
- Runtime exceptions, 460, 466
  
- S**
- Sales, computing, 297, 302, 366
- Sample programs, *see* Appendix B
  - chapter-by-chapter list, 911–932
- saveFile method, 538–540
- Saving AddressBook objects, 716–724
- Saving Java programs, 904–905
- Scanner class, 63–64, 71, 107–112, 309, 351, 420–421, 529, 705–706, 792, 950–951
- Scanner objects, 556
- Scanning, 600, 625
- Scientific notation, 138–139
- scorePanel objects, 831
- Screensaver
  - creating, 298
  - simulating, 273
- Scroll bars, adding automatically, 819
- Search engines, Google, 533
- search method, implementation of, 618–621
- Searches, 634–638
- searchMinimum method, 582
- Second generation computers, 3
- Secondary storage devices, 8
- Selection statements, 221–302
  - key concepts, 286
- selectionSort method, 640–642, 646
- Self-referencing pointers, 379
- Semicolons (;), 225
- Sentinel-controlled loops, 308
- Sequence diagrams, 957–958
- Sequential control flow, 222
- Sequential execution, 222
- Sequential searching, 635
- Serializable interface, 479. *See also* implements
  - Serializable (phrase)
- Service providers, 199–200
- Set interface, 606, 629
- set methods, 158
- setBackground method, 261, 276, 797
- setBounds method, 827
- setCenterPoint method, 278
- setColumns method, 809
- setContent method, 836
- setCurrentDirectory method, 690
- setData method, 653
- setDenominator method, 460
- setExchangeRate method. *See* Exchange rate, computing
- setFile method, 717–719
- setInitialBalance method, 162, 164
- setLayout method, 800
- setOwnerName method, 156, 170–171
- setSize method, 800
- setupArray method, 621, 625
- setVisible method, 38, 80, 276, 794
- Shapes
  - drawing, 277–281
  - selecting, 282–291
- Shipping cost, computing, 148–149
- Short-circuit evaluation, 242
- short data type, 87–93, 97, 254
- Shorthand assignment operator, 98
- Shorthand notation, 500–501
- showCloseDialog method, 691
- showDialog method, 693
- showMessageDialog method, 57, 213, 790–791
- showOpenDialog method, 689–690
- Sibling classes, 742
- Sign bits, 137
- Signature, method, 388
- Silicon chips, 3
- SimpleDateFormat class, 60–63, 122, 335–336, 423, 951–952
  - formatting symbols for, 62–63
- SimpleDateFormat objects, 61–62
- simplify method, 375–376, 378, 408, 410
- Simula (programming language), 12
- Single ampersand (&), 242
- Single-line comments, 40
- Single statements, syntax for, 226
- Single-task object (STO) principle, 609, 613, 697, 720

- Single vertical bar (|), 242
- size method, 600
- Skeleton classes, 203. *See also* Program skeletons
- SketchPad class, 865–869
- sleep method, 258
- Slot machine simulation, 371
- Smalltalk (programming language), 12
- Smooth motion type, 291
- Software development, introduction to, 15–28
- Software engineering, and software life cycle, 24–26
- Software maintenance, 25
- sort method, 654, 667–668, 672–679
- sortedList array, 668
- SortedMap interface, 605, 607
- Sorting, 633–683, 638–641
- Sorting AddressBook program, 659–679
- Sorting passes, 639
- Source code. *See* Programs
- Source files, 49
  - compiling, 50–51
- Sources
  - of inputs, 697
  - of outputs, 695
- Special-purpose dialogs, 790
- Square brackets ([ ]), 557, 584
- Standard classes, 32, 52–68
- Standard conventions, for naming, 34, 46, 76, 78–79
- Standard deviation, computing, 627
- Standard input, 63–68
- Standard output, 53–55
- start method, 201, 280–281, 520, 536, 538–539
- State diagrams, 959–960
- State-of-memory diagrams, 35–36, 78, 90, 380–381, 439–440, 548, 627
- stateChanged method, 854
- Statements. *See also* Assignment statements; Import statements; Output statements; Problem statements
  - for, 327–331
  - branching, 224
  - break, 254
  - compound, 226
  - control, 222
  - do-while, 319–323
  - if, 222–232
  - if-then, 228
  - if-then-else, 246
  - import, 43–46, 78
  - loop, 304
  - nested-for, 332–334
  - nested-if, 233–239
  - repetition, 303–372
  - selection, 221–302
  - sequential execution of, 222
  - single, 226
  - switch, 252–256
  - while, 304–313
  - writing assignment, 101
- static blocks, 663
- Static initializer, 394
- static (reserved word) modifier, 185, 267, 392, 757
- Stationary motion type, 291
- STO. *See* Single-task object principle
- STOP (word), 505, 512, 526
- Stop conditions, multiple, 322
- Storage devices, 4, 8–10
- Stored-program scheme, 3
- Stream objects, 697
- String argument, 270, 689, 772
- String class, 55–60, 70, 248, 338, 420, 499–502, 510, 517, 523, 952–953
  - defined, 55–56, 499
- String concatenation, 59, 527
- String objects, 56–57, 168, 247–251, 270, 514, 521–523, 533, 581, 848
  - comparing, 247–248, 507
  - methods for, 561
- String processing, 86
  - and bioinformatics, 529–532
- StringBuffer class, 524–528, 532, 549, 953–954
- StringBuffer objects, 524–528, 547
  - limits on, 525–526
- StringBuilder class, 524
- Strings, 499–510
  - comparing, 507, 521–523
  - manipulating contents of, 499–500, 524
  - printing in reverse, 509
- StringTokenizer class, 535
- StringTokenizer objects, 772–773
- Structural constraints, 647, 659
- Stub methods, 202, 427
  - stub build method, 542

- Student class, 738–743, 752–761, 770–773
  - Student object, 167, 171–172
  - Subarrays, 594
  - Subclasses, 23, 735, 745–748
    - extending their superclasses, 739–740
  - Subexpressions, 95
    - type casting, 97
  - substring method, 56–58, 73–74, 507, 523
  - Subtraction operators, 94, 298
  - Successful searches, 634
  - Sun Microsystems, 12, 903–904
  - Superclasses, 23, 735, 741–742, 745–749
    - abstract, 753–757
    - defined, 752
    - explicit calls to constructor of, 752
    - extending, 739
  - swap method, 398–399, 656
  - Swing classes, 788–790
  - Swing components, class hierarchy for, 935–936
  - switch statements, 252–256, 296, 323, 454
    - case labels for, 269–270
    - controlling flow of, 255, 295
    - making readable, 256
    - mapping, 253
    - syntax for, 253
  - Switches, toggle, 872
  - Symbolic constants, 100
  - Syntax rules, violations of, 51
  - System class, 32, 816
  - System.exit statement, significance of, 908
  - System.in, 64, 86, 108, 125, 705
  - System.out, 53–55, 64, 86, 125, 128, 134, 213, 338, 351, 459, 542, 851
- T**
- tab control character, 105
  - Tables, 332–334. *See also* Two-dimensional arrays
    - formatting, 589–590
  - Tasks. *See* Program tasks
  - TeachArithmeticFrame class, 875–880
  - Temperature conversion, computing, 142–143
  - Temporary output statements, 202, 226, 764
  - 10BaseT, 10
  - Test output statements, 206
  - TestAddressBookWrite, 721, 723
  - TestCalendar program, 121–122
  - TestDataOutputStream, 701
  - testDelete method, 625
  - Tester class, 395
  - Testing phase, 25
    - duplicate tests, 322
    - never skipping, 136
    - posttest loop, 319
    - pretest loop, 319
    - priming read in, 307
  - testPrint method, 656
  - TestPrintWriter, 704
  - TestRandom class, 360–361
  - Tests, avoidable, 316–317
  - testSearch method, 621
  - Text, drawing on the Graphics context, 293
  - Text editors, 709
  - Text files, 702–703, 726, 759–760
  - Text-related GUI components, 809–810
  - TextHandler class, 810
  - Then blocks, 224–228
    - rules for writing, 228
  - Thesaurus class, 629
  - Third generation computers, 3
  - this (reserved word), 378–386, 796
    - calling a constructor with, 185
  - Throw statements, 454
  - Throwable class, 451–452, 454, 466–467
  - Throwing exceptions, 453–458
  - Thrown exceptions, 446, 460
  - throws (clause), 467–468, 471
  - throwsException (clause), 460
  - Tic Tac Toe program, 830
  - TicTacToeCell class, 835–837
  - TicTacToePanel class, 831, 835–839
  - Toggle switches, 872
  - Tokens, 772–773
  - Top-down development, 199
  - toString method, 60, 170–171, 423, 427
  - toUpperCase method, 502–503
  - Tower of Hanoi puzzle, 888–890, 895
  - Transcription, of DNA, 531
  - Transistors, 3
  - Traversals, 600
    - read-only, 602
  - TreeMap class, 605–608
  - TreeMap objects, 607

Triangular arrays, 594  
 Trigonometric functions. *See* Math classes  
 true (logical value), 93  
 true (reserved word), 38  
 Truth table, illustrating DeMorgan's law, 241  
 try-catch blocks, 449–450, 540, 771  
 try-catch control statements, 449–450, 454–456,  
 467–468, 471  
 try statements, 258  
 Turtle objects, 81–82, 149–150, 219–220  
 Two-dimensional arrays, 589–596  
 Twos-complement format, 136  
 Type cast operators, 97  
 Type safety, 268  
 type variable, 283  
 Typecasting, 96–97, 714  
     syntax for, 97

## U

UML (Unified Modeling Language), 16, 955–962  
     program diagrams in, 35, 955–956  
 UndergraduateStudent class, 738–743, 752–761,  
 770–774  
 Unicode Worldwide Character Standard, 498,  
 506–507  
     lexicographical order of, 507  
 Unified Modeling Language. *See* UML  
 Unit testing, 25  
 UNIX platform, 687  
 Unknown classes, dealing with, 273  
 Unnormalized fractions, 139  
 Unrelated classes, 737–738  
 Unsuccessful searches, 634  
 U.S. Department of Energy, 529  
 U.S. Navy, 3  
 Use case diagrams, 956–957  
 useDelimiter method, 66  
 User interface, improving with a loop, 306–308  
 User manuals, 41

## V

Vacuum tubes, 3  
 Value relationship constraints, 647, 659  
 Value-returning method, 157  
 valueOf method, 83, 270

Variable declarations, syntax for, 87  
 Variable-pitch fonts, 809  
 Variable-size array declarations, 566  
 Variables, 21–22, 86–93  
     assigning value to multiple, 99  
     boolean, 239–247  
     class, 23  
     control, 327–328  
     incrementing, 235  
     initializing, 88–93  
     instance, 23  
     for numbers, 90  
     for objects, 90  
     properties of, 87  
 Vector class, 598  
 Vignere cipher, 553  
 Visibility modifier, 180–183, 741  
 void method, 156  
 Volatile memory, 8

## W

Wages, computing, 297  
 WANs. *See* Wide area networks  
 Watermelons. *See* Gravitational constant  
 Web browsers, 4  
 Web programming languages, 12  
 Weight, recommended, computing, 218, 297  
 while loops, 353, 358, 767  
 while statements, 304–313  
     advantage over do-while statements, 321, 503–504  
     controlling flow of, 305  
     rewriting as do-while statements, 323  
     syntax for, 304  
     writing, 363  
 Wide area networks (WANs), 4  
 Windows, DrawingBoard, 277  
 Windows platform, 687  
 Wireless networking (WiFi), 10  
 Word concordances, 533  
     building, 533–546  
 Word guessing game, 551–552  
 WordConcordance class, 535–537, 541–545  
 WordList class, 533–534, 543, 546, 608  
 WordList objects, 533–534, 543–544  
 Wrapper classes, 603

Write access, 686  
write method, 720–722  
writeObject method, 713–714  
Writing computer programs. *See* Programming  
Writing repetition statements, pitfalls in, 313–318

**X**

Xerox PARC, 12

**Y**

Youngest person, finding, 570

**Z**

Zero, duplicate representations for, 137–139  
Zero-based indexing, 558, 566



*An Introduction to Object-Oriented Programming with Java™*, Fifth Edition takes a full-immersion approach to object-oriented programming. Proper object-oriented design practices are emphasized throughout the book. Students learn how to use the standard classes first, then learn to design their own classes. Wu continues to use a gentler approach to teaching students how to design their own classes, separating the coverage into two chapters.

### Outstanding Features:

- **Standard Java classes**, such as the Scanner class and the GregorianCalendar class, are used effectively to enhance the learning of object-oriented programming.
- **Incremental Program Development** is taught consistently throughout the book using Sample Development programs that are located at the end of Chapters 2 through 13. These longer programs walk students step-by-step through the stages of program development: design, coding, and testing.
- **Diagrams** are used extensively to provide crystal clear illustration of core concepts considered difficult and often misunderstood by many beginners.
- **Student-Friendly Pedagogy** provides students with tips, pitfalls to avoid, design guidelines, review questions, interesting facts, and more. Additionally, the author has incorporated a variety of examples with an eye to making them interesting for students.

### New to the Fifth Edition:

- \* Level-by-level Programming Exercises provided at the end of each chapter and organized into three levels of difficulty.
- \* More examples from the natural sciences are provided in several key chapters.
- \* The Scanner class is used exclusively for getting inputs. The JOptionPane class is no longer used, except when it is introduced in Chapter 14 on GUI programming.

The book is supported by a rich array of supplements available through the text's website: [www.mhhe.com/wu](http://www.mhhe.com/wu)

For students, source code for all example programs, answers to Quick Check exercises, and other resources are provided.

For instructors, a complete set of PowerPoints, solutions to the chapter exercises, and other resources are provided.

### Electronic Textbook Options

This text is offered through CourseSmart for both instructors and students. CourseSmart is an online resource where students can purchase the complete text online at almost half the cost of a traditional text. Purchasing the eTextbook allows students to take advantage of CourseSmart's web tools for learning, which include full text search, notes and highlighting, and email tools for sharing notes between classmates. To learn more about CourseSmart options, contact your sales representative or visit [www.CourseSmart.com](http://www.CourseSmart.com).

The McGraw-Hill Companies



Higher Education

ISBN 978-0-07-352330-9  
MHID 0-07-352330-5



[www.mhhe.com](http://www.mhhe.com)